



Jabiru J160 Constructors Manual

from kit/serial number 237



General>Introduction

Welcome to the Jabiru family, and a family it is.

Jabiru is a small aircraft and aero-engine manufacturer located in Bundaberg, Queensland, Australia. The city has a population of 60,000 and until recently its most renowned export has been the famous (or infamous) Bundaberg Rum. The Jabiru factory is located on the airport at the Western edge of town where a staff of 55 craftsmen turns out these fine aircraft and engines.

We are not just another kit manufacturer; we also build certified aircraft, engines and propellers and have a quality assurance program fully approved by the Australian Civil Aviation Safety Authority (CASA); as far as we know we are the only company doing so.

All of our products are original and have been designed, prototyped and produced in house, so we can support you like no other kit manufacturer can.

Our distributors are fully supported by us and are a ready source of spares and free advice.

You need not have a degree in electrical engineering, an intimate knowledge of hydraulics or a garage full of tools to complete this aircraft. There are no complex or complicated systems on this aircraft. The gear stays down, the prop pitch is fixed and a simple switch operates the flaps. The brakes are hydraulic and the simplicity will delight you.

Your Jabiru kit is designed to be simple to complete and finish, and will provide you with many years of enjoyable flying.

Once completed you will find the aircraft extremely economical with operating costs more associated with a car than an aeroplane, and the ease of maintenance will increase your flying time.

If you're ever in our area call in for a coffee, we'll show you what we're up to and how we make our aircraft and engines.

Safe Aviating and Happy Landings.



Rodney Stiff, Managing Director



General > Constructors manual

Welcome to the Constructors Manual!

In this Manual you will find all the instructions that you will need to build your very own Jabiru, one step or task at a time. Each task in this Manual stands alone, with the intention that each task will be completed before you move on to the next task. There are many good reasons for this approach: you can easily keep track of where you are in the build; it forms a checklist to ensure that nothing gets overlooked; and in many cases a task will be dependant on the completion of a previous task, and if the sequence shown in the *Table of Contents* is followed there will be no issues of this kind.

The *Table of Contents* of this Manual is also the **Build Sequence**.

We suggest that you print the *Table of Contents* out and keep it on the wall in your workshop. As each task is completed mark it off - in this manner you can accurately track your progress while ensuring that nothing gets overlooked.

The manual has been arranged into 2 major **Sections** plus *General* and *Painting* sections:

- *Pre-Paint*
- *Post-Paint*

Which have been further **Grouped** by:

- *Fuselage*
- *Wings*

Each **Group** is then broken down into **Stage**, **Task** and **Step** as required.

In the main the only sets of tasks that can be done without relation to each other are those under the **Group** headings: *Fuselage* and *Wings*. Tasks in one group may be worked on independent of tasks in the other group but the individual sequences under each group really need to remain intact.

This Manual details the procedures that we have refined over many years of certified factory builds, all combined with the experience of many kit builders to produce a document that combines the best of both worlds: efficient, proven factory techniques throughout, but arranged into a build sequence that meets the needs of kit builders.

For example: the first objective for most kit builders is to get the fuselage up onto its wheels and mobile as quickly as possible so that the fuselage can be moved around the workshop/out of the way of the wife's car/outside for cleaning/etc. By way of contrast, in the factory the fuselage remains in a floor-mounted jig for the majority of the *Pre-Paint* tasks, which is not usually an option for most kit builders.

Each task contains photographs of the work in progress in our factory, often in a step-by-step manner in the case of the more complex tasks. While the Manual is formatted in A4 size you may wish to print some pages in A3 size (if you have a suitable printer) for a clearer view should that be required. Each task starts on a new page so you can print out single tasks.

As you work through this manual, and we suggest that you read it right through from start to finish before you start your build, if something is not completely clear please call your dealer or e-mail us for clarification: it may be that we can better explain something for the benefit of future kit builders at the same time as helping you.

Enjoy your build!



Table of Contents

General

General>Introduction	2
General>Constructors manual	3
General>Tools and equipment.....	8
General>Glossary	11
General>Registration and certification	12
General>Reference documentation.....	12
General>Unpacking and support	13
General>Composite standard procedures	14
General>Aircraft grade bolts and lock nuts.....	17
General>Rod ends.....	19
General>Health and safety	20
Pre-Paint>Fuselage>Fit ventral fin and trim horn	21
Pre-Paint>Fuselage>Prepare the fuselage	24
Pre-Paint>Fuselage>Undercarriage>Assemble main wheels	29
Pre-Paint>Fuselage>Undercarriage>Assemble main gear.....	31
Pre-Paint>Fuselage>Undercarriage>Fit main gear.....	37
Pre-Paint>Fuselage>Firewall forward>Fit firewall.....	41
Pre-Paint>Fuselage>Firewall forward>Firewall fittings.....	45
Pre-Paint>Fuselage>Firewall forward>Assemble and fit nose gear.....	51
Pre-Paint>Fuselage>Firewall forward>Fit engine mount and engine	58
Pre-Paint>Fuselage>Firewall forward>Fit propeller flange extension	62
Pre-Paint>Fuselage>Firewall forward>Fit oil cooler	64
Pre-Paint>Fuselage>Firewall forward>Fuel pump fittings	69
Pre-Paint>Fuselage>Firewall forward>Fit ram air cooling ducts.....	71
Pre-Paint>Fuselage>Fit windscreen	75
Pre-Paint>Fuselage>Fit control cables and lines	78
Pre-Paint>Fuselage>Empennage>Fit vertical tail fin	81
Pre-Paint>Fuselage>Empennage>Fit elevator	88
Pre-Paint>Fuselage>Empennage>Fit horizontal stabiliser	92
Pre-Paint>Fuselage>Empennage>Fit rudder.....	95
Pre-Paint>Fuselage>Fit cowling.....	100
Pre-Paint>Fuselage>Fit flap drive shaft bearing blocks	108
Pre-Paint>Fuselage>Interior>Console>Pre-fit handbrake	110
Pre-Paint>Fuselage>Interior>Console>Pre-fit trim control.....	113
Pre-Paint>Fuselage>Interior>Console>Fit control stick.....	117



Pre-Paint>Fuselage>Interior>Fit rudder pedal mount blocks	121
Pre-Paint>Fuselage>Interior>Fit aileron cable brackets	123
Pre-Paint>Fuselage>Interior>Fuel system	127
Pre-Paint>Fuselage>Interior>Fit seatbelt anchors.....	131
Pre-Paint>Fuselage>Pre-fit doors	133
Pre-Paint>Fuselage>Fit windows	137
Pre-Paint>Fuselage>Wheel alignment	139
Pre-Paint>Fuselage>Pre-fit wheel spats.....	141
Pre-Paint>Wings>General.....	144
Pre-Paint>Wings>Fit fuel tank filler body	145
Pre-Paint>Wings>Prepare wing root	149
Pre-Paint>Wings>Cut aileron cable openings	153
Pre-Paint>Wings>Fit quick drain sumps	156
Pre-Paint>Wings>Mount flaps	158
Pre-Paint>Wings>Fit wing tips	165
Pre-Paint>Wings>Fit ailerons	167
Pre-Paint>Wings>Fit pitot tube to strut	173
Pre-Paint>Wings>Test fit wings.....	175
Paint>General	180
Paint>Masking.....	182
Paint>Surface preparation	183
Paint>Topcoat.....	184
Post-Paint>General	185
Post-Paint>Fuselage>Fit panel mounted throttle.....	186
Post-Paint>Fuselage>Assemble instrument panel	189
Post-Paint>Fuselage>Electrical wiring diagrams	201
Post-Paint>Fuselage>Interior>Fit upholstery 1	207
Post-Paint>Fuselage>Install electrical wiring	210
Post-Paint>Fuselage>Interior>Fit console controls	222
Post-Paint>Fuselage>Interior>Controls>Fit rudder pedals.....	227
Post-Paint>Fuselage>Interior>Fit flap drive motor	234
Post-Paint>Fuselage>Interior>Fit instrument panel housing	237
Post-Paint> Fuselage>Interior>Engine control cabling	240
Post-Paint>Fuselage>Interior>Fit the instrument panel.....	243
Post-Paint>Fuselage>Interior>Fit upholstery 2.....	244
Post-Paint>Fuselage>Fit rudder, elevator and elevator trim	247
Post-Paint>Fuselage>Fit doors.....	252
Post-Paint>Fuselage>Firewall forward>Final assembly.....	255



Post-Paint>Fuselage>Firewall forward>Fit propeller and spinner	259
Post-Paint>Fuselage>Fit wheel spats.....	263
Post-Paint>Wings>Install aileron cables.....	264
Post-Paint>Wings>Fit stall warning	266
Post-Paint>Wings>Prepare wings for fitting.....	268
Post-Paint>Wings>Fit wings	272
Post-Paint>Wings>Connect ailerons	274
Post-Paint>Wings>Connect wing tanks.....	277
Post-Paint>Wings>Fit flaps.....	278
Post-Paint>Wings>Fit fairings	280
Testing>General	282
Testing>Weight and balance	283
Testing>Rigging check	287
Testing>Calibrate fuel gauges	290
Testing>Registration markings.....	292
Testing>Final inspection checklist	293
Testing>Flight testing	308
Testing>Forms.....	321



Direction references

In all cases throughout this manual when any reference is made to direction (left, right, front, forward, rear, aft) it is made relative to the pilot's point of view, where the pilot is assumed to be sitting in the pilot's seat facing towards the front of the aircraft.

“Lateral” means something that it is oriented from *side to side* in relation to the aircraft.

“Longitudinal” or “Fore and aft” means something that it is oriented from the front to the back of the aircraft.

Preparation

We suggest that you get as much preparation done as possible before starting your build.

Start with your workshop: give it a good clean out and consider upgrading the lighting and power with plenty of strip lights and extra sockets for power tools. Paint the walls and ceiling a light colour to provide as light a work area as possible. This will also help if you plan to prepare the aircraft for painting preparation (filling/primer) and also the topcoat if you feel you are capable of doing so.

In preparation for storing the vacuum-sealed *Build Cards* that pack many of the small parts into convenient groups we suggest that you construct a large wallboard that you can place the *Build Cards* on, preferably in numerical order (each Card is numbered) – you will find that this is much easier and more pleasant than sorting through a box or pile of *Build Cards*!

For items such as fairings and instrumentation prepare as much protected shelf space as you can find (some shelving under a workbench can be particularly useful in this instance) and also make a vertical bin in a cooler corner of the workshop to stand long items like elevator, rudder and flaps in while building the relevant parts of the aircraft. Reserve an out-of-the-way area for windows and other fragile parts.

In our factory we use large mobile bench/racks that contain all of the parts for an aircraft and that rack stays with that aircraft all the way through production.

If you're going to do any painting, try to keep equipment and parts off the floor as much as possible so that you can sweep/vacuum/hose the place out thoroughly in order to minimise dust before you start any painting.

Get all of the tools and equipment on the list that starts on the next page.

Read this manual from start to finish to familiarise yourself with the work to come.

Consider getting extra insurance cover for your kit during the build to cover any risks (fire/damage/theft, etc). Most aircraft insurers will quote for this and many builders consider that the cost is worth it for the peace of mind that it brings.

Cold climate considerations

If you are building in a colder climate/during winter, some extra heating and insulation in your workshop will help, as well as keeping the humidity levels up to acceptable levels for epoxy work. Clearly, all workshops are different and your build inspector will advise.

Get a large roll of bubble wrap packaging sheet (1.5m x 15m) from your local garden centre or packaging company (usually cheaper). In low temperature environments you will use this to create an insulated tunnel by draping it over the work you've bonded/flocked and, with the careful application of warm air from a fan heater, you'll easily achieve the 24°C (or so) you need for a good epoxy cure.

General > Tools and equipment

Before getting started we recommend that you acquire the following tools and equipment: these tools are *not* included in the kit and must be supplied by you.

Required tools

The following tools and equipment will be required as a bare minimum to complete this kit:

Allen keys: imperial set.

Aluminium angle: 3 or 4 straight lengths of 20x20x3 angle approximately 2m in length.

Clecoes: Clecoe pliers and at least 20 Clecoes.

Digital Kitchen Scales: (up to 5kg measured in 10 gram increments) for mixing resins by weight, using the mixing pots provided. Accurate measurements of small mixes can be made. Slip the scales into a clear plastic bag to keep them clean – the scale can still be read through the bag.



Disposable gloves: for handling of epoxy and resin.
Buy a large box from the supermarket or hardware supply store.

Drill bits: 1/8" to 1/2" normal shank, 5/32" and 3/16" extended shank.

Electric drill: 3/8" chuck, preferably cordless with a variable speed trigger.

Electric hot air (paint stripping) gun: used to 'adjust' some non - structural glass fibre airframe parts, like doorframes, door stop strips, etc.

Electric soldering iron: for general wiring as well as removing temporary screws.

Files: medium flat, medium and small rat-tail, medium half-round.

Hacksaw blades in holders for cutting in restricted spaces.

Hole saws: 1 1/2" to 2" or metric equivalents.

Masks: disposable paper face masks and/or a half-face respirator with suitable filter elements.

Nylon spring clamps: these come in mixed size bags from hardware stores and you will use them in a multitude of ways. Get 2 or 3 bags plus 3 or 4 big individual clamps.

Ring-open ended spanners: 3/8", 7/16", 1/2" and 7mm

Padding: felt or old blankets for various uses.

Pop rivet gun: hand operated or pneumatic.

Sandpaper: various grades between 80 and 240 grit. Detailed in the *Painting* task.

Screwdrivers: Phillips: small & #2, medium flat blade.

Socket set: 1/4" drive: at the very least 3/8", 7/16" and 1/2" sockets.

Torque wrench: for engine/prop fitting, etc. Check the torque settings in the *Technical Manual* that shipped with your kit to ensure you get one with the right range.

Trestles: at least 2 required, preferably 4 at about 800-900mm high with carpet covered tops.

Wet and dry bulb thermometer or calibrated hygrometer for the wall of your workshop.



Optional tools and equipment

The following tools are not essential, but they will certainly make the job more pleasant:

Air Compressor & Air Gun. You can probably do without this if you plan to contract out your filling and painting job, but if you intend to prime/fill/paint then you'll definitely need to use the air gun to clean out crevices and pinholes in the gel coat. If you intend to do all of your own painting then get a good quality spray gun and a compressor capable of at least 15cfm. You will need to include a good quality water trap too – anywhere that compressors and air tools are sold will be able to advise you on brands and specifications.

Cordless Screwdriver with various bits (get some spare Phillips #2 bits: those self-tappers are really hard!)

Dremel Moto-Tool (or similar, cordless and multi speed if possible) used for grinding and drilling glass fibre in hard-to-get places. **Permagrit** make some very useful bits for these: the cut off disc and cylindrical grinding tools can be particularly handy.

Electric or Pneumatic Angle Grinder (4 - 5"), preferably with a vacuum cleaner attachment to keep dust to a minimum. This is for grinding parts like the trailing edge of the wing above the flaps. If you can get an adjustable speed one then so much the better. Fit a disc sander backing pad and use discs between 80 and 240 grit.

Electric or Pneumatic Jig Saw for cutting holes such as the aileron/flap fitting holes in the wing and other holes in wing/fuselage/empennage.

Electric or Pneumatic Orbital Sander for surfacing filler, preferably with a vacuum cleaner attachment to keep dust to a minimum.

Industrial Vacuum Cleaner with 'crevice tools' A domestic vacuum may not be up to the task, and as industrial units are readily available we suggest the purchase of a suitable machine. You will be surprised how difficult it is to get glass fibre dust out from behind the seats with just a brush! Get any fittings necessary to connect to your sanders and grinders. We use several of these units in our factories and the amount of glass fibre dust lying around at any time is minimal. A very worthwhile investment.

Lock Wire Pliers to put that professional twist on all of your lock wire.



To use: lock the jaws onto both ends of your lockwire using the silver lock handle, then simply pull the "twist" handle at the back of the pliers and presto, perfect lockwire!

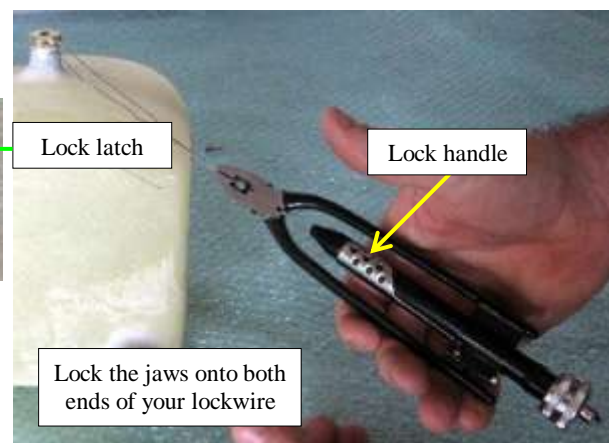

Pedestal Fans to blow fresh air across work surfaces. We use plenty of these in our factory.

Permagrit-type Shaped Abrasive Tools for shaping/sanding glass fibre parts (try to get a set of various shapes). Or make your own **Sanding Blocks** as described further down the page.

Pneumatic tools are great if you have a compressor that can drive them – drills, jigsaws, various sanding tools are widely available. We use plenty of these in our factory too.

Scales for weighing the aircraft: must be capable of weighing up to 150kg. Regular bathroom scales are fine for this task. A single scale can be used, but these scales are quite reasonably priced (less than \$50 each in Australia currently) and the task is much easier with 3 scales.

Setsquare the long builders type with each side at least 500mm in length.

Silicone Sealer, *General Purpose* or *Roof and Gutter* sealer, must suitable for use on metal.

Spade Drill Bits as used in woodwork (pictured at right).

Used to recess the threaded inserts in the ventral fin and the lower strut fairings.



Straightedge in 2 lengths: a 1 metre builders level type is good for aligning the flaps to wings and checking the control surface deflections, while a 3 metre long length of 100mm RHS (rectangular hollow section) aluminium is excellent for checking the rear of the wing and aligning the horizontal stabiliser: make sure that you buy a straight length with no dents.

Sanding Blocks - stapling 80 grit emery tape around the ends of a length of straight timber about 600mm long (shown below left) is very useful for achieving straight edges on items such as trailing edges, flaps, etc. Taping emery tape to a short length of tubing (shown below right) can be useful for things like the final sizing of the fuel filler body holes in the wing/tank and so on. You will use plenty of sanding blocks as you progress through your build, and with a little bit of imagination you can make them in almost any size and shape that you need.



TorqueSeal – brand name security sealing lacquer used to show that nuts have been tightened to safety or to the recommended torque setting and require no further work. Try aircraft parts or engineering suppliers for this product. Comes in several colours.

Loctite compounds

This brand name compound is considered essential in the construction of your Jabiru.

Purchase the following grades:

Type	Use	Appearance
242	Thread locker medium strength	Blue liquid
262	Thread locker high strength	Red liquid
518	Sealant, form-in-place gasket	Red gel
577	Thread sealer medium strength	Yellow paste
620	Thread retainer high strength	Green liquid
7063	Cleaner – can use Acetone in place	Clear solvent, aerosol applicator



General>Glossary

Here is a glossary of common composite terms that are used throughout this manual:

<u>Term</u>	<u>Description</u>
5-Minute Araldite	Quick setting brand name epoxy glue.
AT133 (not supplied)	Fibreglass cloth with wide unidirectional strands, which provides great strength for weight. It is used in the fabrication of the spar and undercarriage legs.
AT244	This is a standard bi-directional cloth that is used extensively for plates and other flat surfaces.
AT303	This is a twill weaved cloth that can be moulded into curves and is therefore used for wing and fuselage skins, cowls, etc.
AT312	A 2" wide glass tape.
AT313	This 3" wide glass tape is used to joint other glass structures. The edges of glass tape do not fray like glass cloth.
Body Filler – (bog)	Lightweight automotive filler used in paint preparation.
Clecoes	Patented reusable fasteners used to align parts prior to flocking and fixing with pop-rivets. Store in Acetone to keep them clean.
Coremat	Lightweight core material used to make sandwich panels.
Flock	Low-grade short fibre reinforcement for resin. Also used as a verb: to "flock something into place" for example.
Gelcoat	White polyester resin film used on exterior of supplied fibreglass parts to provide a smooth finish.
Glass	Fibreglass cloth. Also describes the process of wetting fibreglass cloth into a mould or onto parts: to "glass something into place".
Joggle	Recessed step where 2 surfaces are to be flush joined. An example is the joggle around the windscreen and windows.
Lay-Up	Resin wetted fibreglass cloth laid into a mould or onto parts.
LC 3600 Epoxy	Epoxy system used on all structural parts.
LC 3600 Hardener	¼ part of LC 3600 epoxy.
LC 3600 Resin	¾ part of LC 3600 epoxy.
Peel Cloth	To provide a surface that requires minimal preparation before bonding, polyester cloth is included as the top layer of a glass lay-up. The cloth is simply 'peeled off' and the surface beneath is ready for bonding, hence the name.
Polyester Resin	Resin system that uses a catalyst to cure. Does not provide good structural properties like epoxies, and for this reason is not used on any structural parts in your Jabiru.
Q-Cells (not supplied)	Inorganic micro-spheres mixed with resin and used as a lightweight filler, usually used in paint preparation.
Resin	Generic term used to refer to the LC3600 epoxy/resin mix.



General > Registration and certification

The accuracy of records and correct administrative procedures are just as important as the quality of workmanship in your project.

By now you should have established the regulations under which you will build your aircraft.

In Australia you have two options:

1. Experimental Rule
2. CAO 95.55 Amateur-built Ultralight Category

Option 1 is administered by the **Sports Aircraft Association of Australia (SAAA)**

Option 2 is administered by **Recreational Aviation Australia (RAA)**

Aircraft built under *Option 1* can only be General Aviation (VH-) registered and must carry “EXPERIMENTAL” markings.

Aircraft built under *Option 2* can only be registered with the RAA and must carry “19” series registration numbers.

You should consult the appropriate administrative association on their requirements for documentation, inspections and project administration.

Contact details are: **Sports Aircraft Association of Australia (SAAA)**
PO Box 169
Clifton Hill, VIC 3068
Phone: 03 9482 4716
Fax: 03 9482 3936

Recreational Aviation Australia (RAA)
PO Box 1265
Fyshwick, ACT, 2609
Phone: 02 6280 4700
Fax: 02 6280 4775

Internationally you will need to establish the requirements for building your aircraft under the appropriate regulations governing amateur aircraft building in your particular country.

Your local Jabiru distributor can give you guidance on who to consult and how your project should be administered.

In all cases, however, it is your responsibility as an amateur builder to ensure that you are fully informed of the requirements and to ensure that you meet these requirements.

General > Reference documentation

The FAA Advisory Circular “*Aircraft Inspection, Repair and Alterations*” (publication AC 43.13-2A, ISBN: 1560270985) is an excellent reference work that covers all aspects of aircraft building and repair, and it can be downloaded or purchased online from several suppliers of technical publications.

The FAA Advisory Circular “*Amateur-Built Aircraft and Ultralight Flight Testing Handbook*” (publication AC 90-89A), addresses the topic in considerable detail and which may be obtained here: www.faa.gov/library/manuals/.



General>Unpacking and support

Unpack the wing box first and inspect the contents: there should be two wings. Inspect for transit damage then close the box and store, as the wings will not be required for some time.

Unpacking the main box is a much more complicated task as there are hundreds of parts and they all have to be inspected for transit damage.

The first thing you should do is locate your packing list which is in with all the individual components that have been packed with your fuselage. This list will show you all of the components that have been packed, each of which should correspond with the specific type & model of aircraft that you have ordered.

Your kit was triple checked when it was packed in our factory, but PLEASE check off every single part as you unpack it: mark off every item so that YOU can be sure that you have received them.

You could also make a note of *where* you plan to store each part or group of parts.

Please notify Jabiru of any missing parts within 3 months of the receipt of your kit.

At this stage it would be a good idea to store your instruments in a low humidity environment.

Store your propeller in a horizontal position.

Treat all the steel components with an anticorrosive substance.

Fibreglass components will soften and change shape when heat is applied, so keep this in mind when deciding where to store your parts. For example: storing your flaps between the rafters in the heat of the roof is a very ***bad*** idea if you live in a hot sunny climate.

Here at Jabiru we pride ourselves on our after-market support, and if you have any difficulties through the building process we would be happy to help you to resolve them.

We provide product support via email, phone or fax.

Start by checking the resources on our web site at: www.jabiru.net.au and contact us:

Email: info@jabiru.net.au (please send us a fax or call if no read receipt is received)

Phone: +61 (0)7 4155 1778 - (8.30 am-4.30pm AEST (Australian Eastern Standard Time))

Fax: +61 (0)7 4155 2669

Spare Parts Department

Email: spares@jabiru.net.au

Phone: +61 (0)7 4155 2917 - (8.30 am-4.00 pm AEST)

Service Department

Email: engines@jabiru.net.au

Phone: +61 (0)7 4155 2811 - (8.30 am-4.00 pm AEST)

Postal Address:

Jabiru Aircraft Pty. Ltd.

P.O. Box 5792

Bundaberg West QLD 4670

AUSTRALIA

Location:

Airport Drive

Bundaberg West QLD 4670

AUSTRALIA

General > Composite standard procedures

Composite introduction

Composite construction techniques may seem mystifying to those who have never been involved with composites before but they are straightforward and require only a few basic procedures.

Composite surface preparation

For bonding composite-to-composite or composite-to-metal the surfaces must be prepared in the following ways:

With peel cloth

Where it is known that a surface will be bonded to another surface, peel cloth is usually incorporated in the lay-up under the gelcoat to provide a bare, clean 'virgin' surface to aid the builder.

Typically peel cloth is included in the lay-up for all structural components: vertical fin, horizontal stabiliser, flaps, aileron pre-molds, etc.

To prepare the surface for bonding simply cut at the edge of the peel cloth with a knife and peel the peel cloth off as shown in the photo at right, then lightly roughen the surface by sanding to provide a good 'key' for the epoxy to bond to.

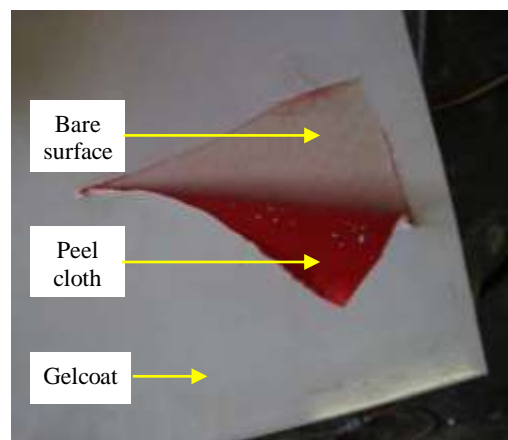

Peel cloth is typically red in colour as shown, although other colours are sometimes used.

If you are in any doubt about the area that you intend to glass to, sand away the gelcoat and if you see anything that is *not* bare fibreglass then do **not** glass to it until it **is** bare fibreglass.

NEVER, NEVER, NEVER glass over the top of peel cloth!

Without peel cloth

Where there is no peel cloth for a bonding surface the surface must be free of gelcoat, grease and contaminants and must be sanded lightly to provide a good 'key' for the epoxy to bond to.

Metal

If it is necessary to bond to composite to metal, the metal surface must be degreased and roughly sanded to provide a good 'key' for the epoxy to bond to.

Summary

Careful surface preparation is *extremely important* when working with composites: all surfaces to be bonded must be absolutely clean and must be roughened in order to provide a good 'key' for the epoxy to bond to.



Epoxy measuring and mixing

Quality assurance and record keeping

In Australia the SAAA require that a wet and dry bulb thermometer is kept in the room where the lay-ups are done. A further requirement is that a sample of each mix is kept as a quality assurance step. In your builders log you should record the wet and dry bulb temperatures, the mix number (all samples to be numbered) and the batch numbers of the resin and hardener.

Samples of resin batches should be retained, dated and labelled according to the Task on which the batch was used. Samples should be inspected after 24 hours to ensure correct curing. The cured resin should be hard and "scratch-able".

A good sampling device is a small plastic medicine measure cup: wipe the interior of the cup with wax before each use to facilitate easy removal of the sample. Samples should not exceed 10mm in depth otherwise the heat generated during curing may affect the result.

Measuring epoxy

The Epoxy system used for the production of Jabiru Aircraft is LC3600, which is mixed in a 3:1 ratio, which means that 3 parts of resin are mixed with 1 part of hardener.

The best method for ensuring accurate measuring is to use a digital kitchen scale as described in the section *General > Required tools and equipment* which is what we do in our factory.

Curing times

The LC3600 is a room temperature (24° Celsius minimum) curing epoxy so it requires no elevated temperature curing unless you are working in a particularly cold climate or perhaps during winter months. The recommended curing time depends upon temperature but a minimum of 24 hours is good rule of thumb.

Mixing epoxy

When mixing the epoxy the mixture will initially appear 'cloudy' then as you mix the mixture will become clearer but 'stringy', keep mixing and finally you'll be left with a clear mixture with no sign of being 'stringy'.

Note: The smaller the mix the larger the possibility for errors, so consider combining several tasks and doing a larger mix wherever possible.

Mixing in flock

As a general rule, mix flock so you can take a sample with a mixing stick turn it over & it does not dribble off. If it is a little too runny, add more fibre flock.

Mixing epoxy and milled cotton flock together creates an excellent filler which is used in many places to form edges and fillets. The mixture is referred to as 'flock' but is often used as a verb, for example: "flock the bracket into the position shown..."

Mixing 5-minute Araldite

5-minute Araldite is a fast curing epoxy and is very useful for bonding non-structural items into place. If you find that your Araldite won't cure it is usually because 2 lots of the same part were used instead of 1 each. We have all made that mistake at least once.

Mixing 5-min Araldite with cotton flock creates a good paste for 'bedding' parts into place.

Same rule applies as for mixing Epoxy.



Composite general

Glassing procedure

Any lay-up of glass fibre cloth should follow this general procedure: make a mix of resin and brush a coat of resin onto the entire area to be glassed, then lay the first piece of cloth on and carefully brush it into place, adding small amounts of resin to the brush as required to wet the cloth, until the resin has completely saturated the cloth: the cloth seems to change colour slightly from a silvery white to a colour close to that of the surrounding surface when it is saturated with resin.

Once the first layer of cloth has been successfully brushed on, apply the second layer and brush that on in the same manner, adding small amounts of resin as required to wet the cloth.

Repeat for as many layers of cloth as the task requires.

Peel cloth

Peel cloth is supplied in the bags of glass fibre cloth in the kit. The intended use for this peel cloth is to brush it onto the top of a layed-up area of glass fibre cloth.

The peel cloth will smooth out the finished surface by allowing the resin to level off across the weave of the glass fibre cloth and provide a good surface for painting preparation.

Trimming edges of glass fibre cloth

There are two times for trimming edges, these are before curing while the epoxy is 'tacky' (approximately 2 to 4 hours after mixing) and when the structure is fully cured.

Various tools are used for trimming edges but for thin or 'tacky' lay-ups a sharp utility knife may be used. Thicker cured edges may require a jigsaw and a rough file to trim. A heat gun may be used to soften cured edges so that a utility knife can trim them.

Inspection and evaluation

Each lay-up will require an inspection and evaluation after curing.

Inspect for soft or wet patches after a reasonable time for curing has been allowed, as such wet or soft areas may indicated an improperly mixed batch of epoxy.

Care must be taken to check that areas have actually been bonded together and that there are no air gaps or bubbles between the layers of glass, especially in curves/radii.

Removing screws

Self-tapping screws are used to hold parts in place while epoxy is curing but once the epoxy has cured it can be difficult to remove the screws.

Use your soldering iron to heat the head of the screw and the composite around the screw will soften allowing the screw to be removed easily.

This is also a handy trick to use if any bushes are not perfectly in line and need a slight adjust.

Clecoes

Clecoes are used to hold hinges while they are being flocked into place prior to riveting and so they must be free of oil and grease that could contaminate the surface to be bonded, and they will inevitably get flock onto them during the bonding or flocking process.

To prevent these problems, keep your Clecoe fasteners stored in a sealed tin of Acetone to ensure that they remain clean and ready for use – the Acetone will dry off them in seconds.

General>Aircraft grade bolts and lock nuts

General

All bolts 3/16" or larger in diameter that have been supplied with your Jabiru kit are Aircraft grade bolts.

Under **no** circumstances must any bolts other than Aircraft grade bolts be used on your Jabiru. Aircraft grade bolts are significantly stronger than regular commercial grade bolts and have features such as corrosion resistance that have been designed specifically for aircraft use.

Aircraft grade bolts are quite different in appearance to regular commercial grade bolts in several ways: Aircraft grade bolts are usually gold or silver in colour; they have a relatively short thread length and a longer plain shank or grip length.

In almost all cases the supplied and specified bolts will be the correct length for each task, but kit builders need to be aware of the correct method of determining and/or checking the correct length of bolts and also the correct method of tightening lock nuts.

The parts of a bolt

There are 2 variable lengths to an Aircraft grade bolt: the overall length, usually just referred to as the **length**, and the **grip length**, which is the length of the plain shank of the bolt, which is measured from underneath the head of the bolt to the beginning of the threads (see the drawing at right).

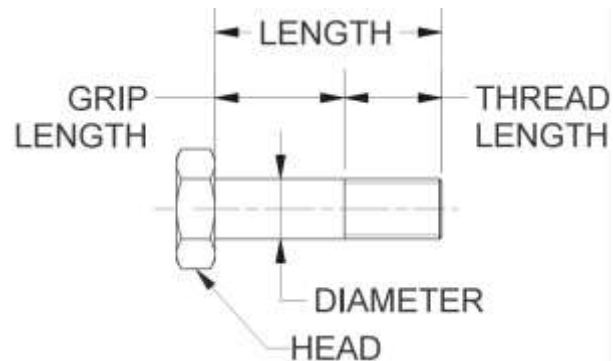

The **thread length** is generally fixed in relation to the diameter of the bolt.

Bolt identification

Aircraft bolts supplied with your Jabiru kit are identified in this Manual and in Jabiru drawings by the prefix letters "AN", the diameter (measured in 1/16" increments) and the length (measured in 1/8" increments) of the bolt and a suffix, which is usually "A".

Examples of bolt identifiers would be: AN3-6A, AN4-14A, AN3-22A, AN4-72 and so on.

For example, for an **AN3-5A** bolt:

- **AN** means the bolt has been manufactured to Aircraft (Military) standards
- **3** the diameter of the bolt in 1/16" increments: (3/16" in this case)
- **-5** (the dash number) the length of the bolt in 1/8" increments: (5/8" in this case)
- **A** not drilled for a lock pin. Bolts with no "A" here are drilled for a lock pin

If the dash number defining the length of the bolt has two digits, the first digit is the length in whole inches and the second number is the length in additional 1/8" increments. This can become complex and if you feel the need to delve deeply into the subject you can locate an AN bolt chart online or purchase an AN bolt gauge from suppliers of Aircraft grade fasteners.

The last example given above (AN4-72) there is no "A" suffix, which indicates that the threaded end has been drilled during manufacture for a lock pin while the other 3 examples all have the suffix "A" and do not have provision for a lock pin.

Determining and checking bolt lengths

A bolt must be long enough to ensure that no more than one thread will be inside the bolt hole when the bolt is fitted. This *grip length* should be equal to the material thickness that is being held by the bolt.

What this means is that **the correct bolt length must be used in every case**, and if a nut cannot be tightened to safety then measures must be taken to correct the length, either by packing with washers (an absolute maximum of 3 flat washers may be used for packing, starting with the required washer under the nut, then one washer under the head of the bolt and finally, if needed, another washer under the nut) or using a different length bolt.

Lock nuts

All bolted components on your Jabiru aircraft are held in place with lock nuts, either a *Nyloc* type fibre lock nut for most uses or a steel lock nut for hot areas such as in the engine bay.

It is important to understand the procedure for tightening Aircraft lock nuts: each nut must be fitted with a flat washer under it and “*tightened to safety*”, which is defined as having a minimum of 1½ threads and a maximum of 3 threads showing beyond the end of the lock nut.

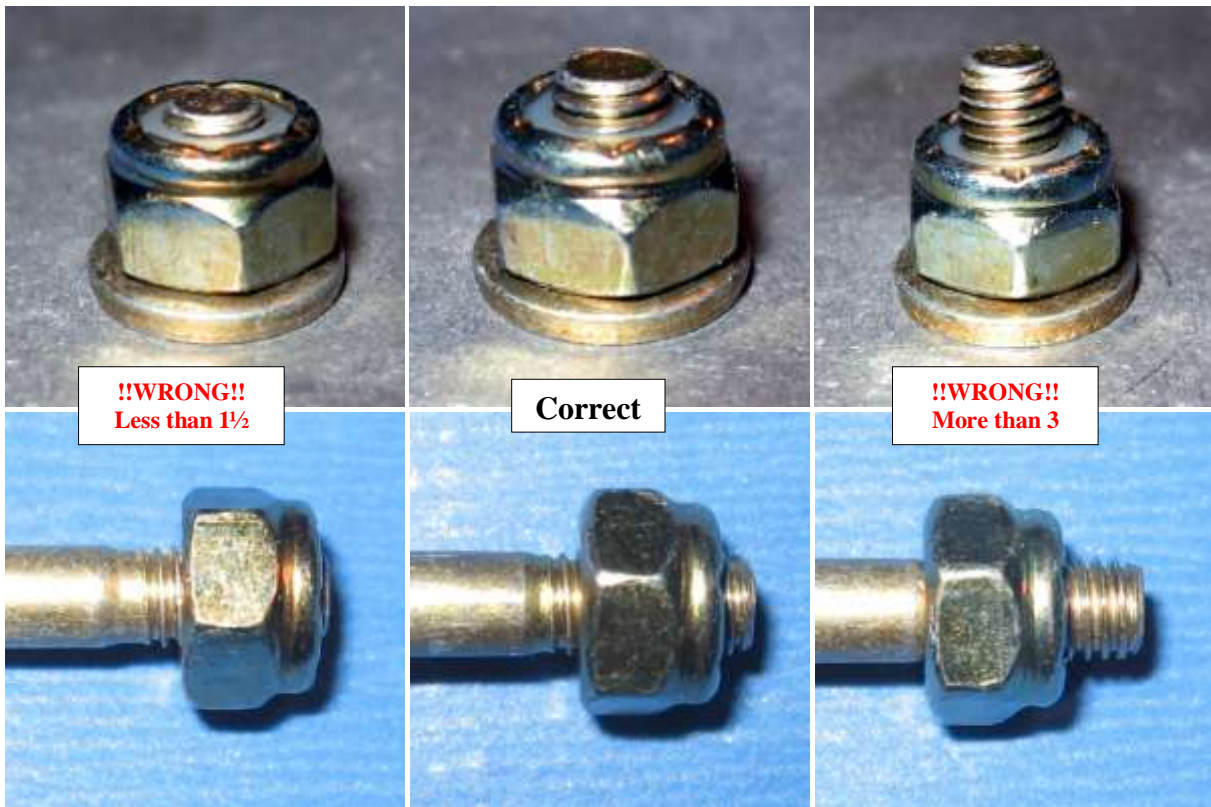

This is considered **critical** for load-bearing bolts and good practise for all other bolts.

Any less than 1½ threads showing beyond the end of the lock nut means a risk of the nut not locking correctly while any more than 3 threads showing beyond the end of the lock nut could mean that the lock nut is bottoming on the thread and there is a risk overstressing the bolt and nut and/or not gripping the joined material correctly. Examples of each case are shown above.

In general all nuts should be fitted so that they face outward so that they can be easily inspected. Nuts inside the cabin should face out and towards the pilot if at all possible.

Nuts that have been tightened to safety should be marked with a dab of *TorqueSeal*.

General > Rod ends

It can truthfully be said that the rod ends are the sole connection between the pilot and the control surfaces of your Jabiru.

A very important item of hardware indeed!

Given the vital role that each and every rod end performs in your Jabiru it is equally important that you familiarise yourself with the correct method of connecting rod ends.

There are 2 parts to connecting a rod end: the *cable connection* and the *drive connection*.

Cable connection

All cable rod ends are female rod ends, which is to say that the cable (the male end) is screwed into the rod end (the female end) the cable length can be adjusted by screwing the rod end further onto the cable or further off the cable, and then the cable is fixed to the rod end by means of a jam nut on the cable that locks the threads from turning.

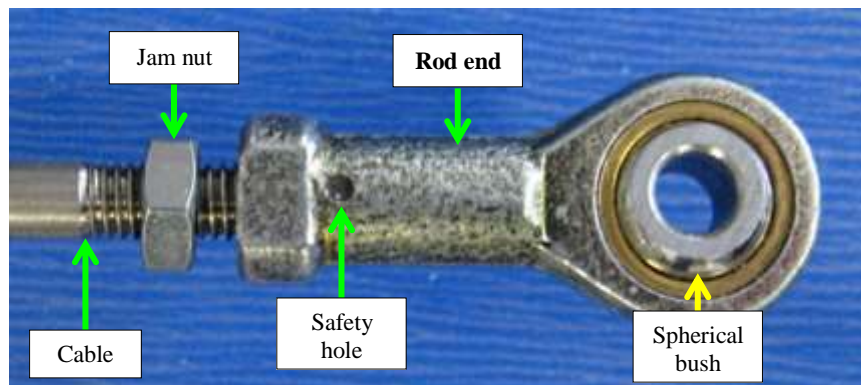

There must be enough cable thread length in the rod end to provide strength and security, and each female rod end has a small hole, called the *safety hole*, part-way along one side through which the cable threads **must** be visible – if you cannot see the cable threads through the safety hole, then you **must not fly the aircraft** until adjustments have been made so that the cable threads are visible through the safety hole.

This is of the utmost importance and cannot be overstated!

Drive connection

Most of the rod ends on your Jabiru are driven by a 3/16" bolt through the spherical bush, and they must be connected in the following manner: between the rod end and the drive lever, fit one 3/16" flat washer (or more in the case of the flap drive arms – details in the *Flaps* task).

Between the rod end and the retaining nut (or the head of the bolt, depending on which way the bolt is fitted) fit one 1/4" flat washer (one size larger than the bolt).

The purpose of this larger flat washer is that should the spherical bush in the rod end fail, the large washer will provide a margin of safety by preventing the rod end from leaving the drive bolt. In the photo at right you can see the way that the washers are fitted.



In practical terms, should a rod end fail internally in flight the rod end will still remain connected to the drive bolt and the control will continue to function.

Thus the correct fitting of the flat washers to rod ends is extremely important.



General > Health and safety

Working with composites is no different than working with other chemicals and flammable materials, and caution and common sense should prevail at all times.

NO SMOKING

Do not smoke or have any exposed flames near your kit or resin storage area.

Epoxy **will** burn.

Warning: the fumes from burning epoxy are **extremely** toxic!

Epoxy

Long term exposure to epoxy can lead to an 'epoxy allergy' so suitable safety precautions should be taken as follows:

Contact

Do **not** expose your skin to epoxy. Neoprene, latex or nitrile rubber gloves (with pure cotton gloves worn underneath to wick away sweat from your hands) and protective (industrial) clothing should be worn when handling epoxies.

If epoxy is spilt onto the skin, wash off with warm water and soap immediately.

Barrier cream can help the skin to avoid becoming sensitised. Note: if barrier cream is used take care to keep it away from any surfaces to be bonded by wearing gloves – the cream could contaminate and weaken the join so keep the cream inside your disposable gloves at all times.

Fresh Air

Epoxy fumes should **not** be inhaled. Blow fresh air across the work face at all times.

The use of an external fresh air source and facemask is strongly recommended along with the use of a fan for blowing the epoxy fumes away. In our factory we use several industrial pedestal fans to blow fresh air across the work surfaces at all times.

Dust

Always wear a dust mask when sanding or cutting composites. Cutting and sanding composites creates a lot of dust and the extremely fine glass dust should **not** be inhaled.

A half-face respirator with suitable filters is highly recommended and should be worn at all times when sanding fibreglass parts.

OK, lets get building!

Pre-Paint>Fuselage>Fit ventral fin and trim horn

Objectives of this task:

To fit the ventral fin, trim horn and cut the related rear fuselage penetrations. This task is carried out while the fuselage is inverted and supported on trestles.

Materials required:

Epoxy resin and flock, 5-minute Araldite

Hardware box #4

Cut the cable and tube slots

The cable and tube slots are marked on the underside of the fuselage with marker pen.

Cut out the marked slots on the fuselage centreline. Each slot should be drilled at each end to about ½” and then the holes can be joined by cutting along the lines with a jigsaw.

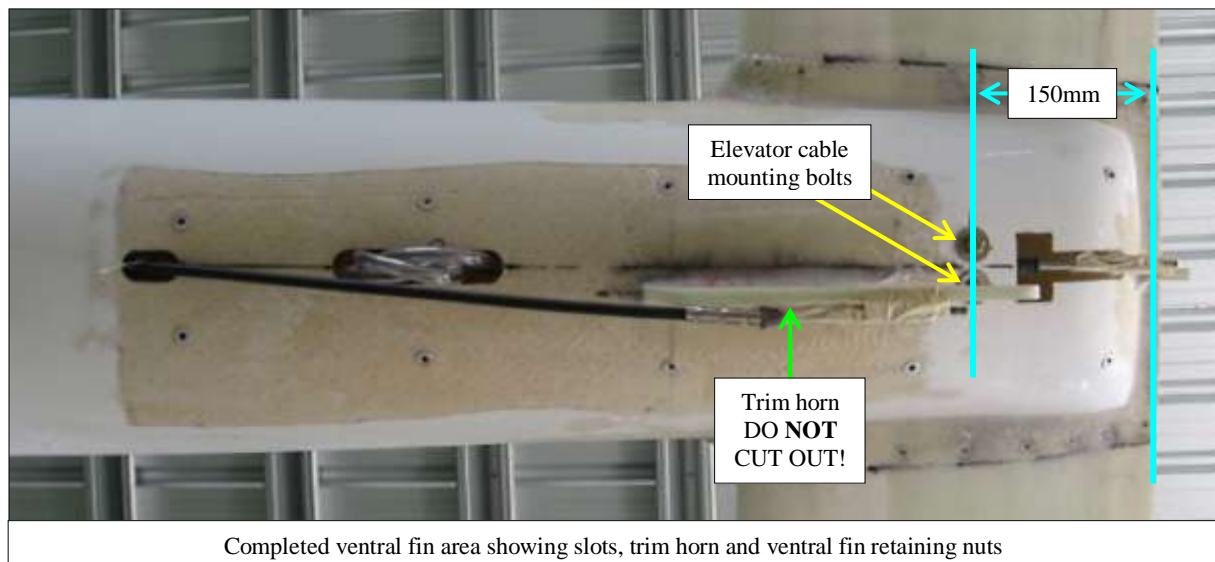

We find that widening the elevator cable slot (the slot at the very rear of the fuselage) as shown in the photo above can provide useful access later in the build.

Do **not** cut out the line marker for the trim horn! The trim horn marking can be transferred through the peel cloth by scribing around the marks with a sharp knife, cutting just deep enough that the cut can be seen once the peel cloth has been removed.

File and sand all cutouts to a good finish. Remove the peel cloth from the ventral fin area (rear underside) of the fuselage.

Check the elevator cable mounting holes: test fit the horizontal stabiliser to the fuselage and push it all the way forward. Hold a set square against the rear of the horizontal stabiliser and along the fuselage and measure *exactly* 150mm forward from the rear of the *stabiliser* (and *not* the fuselage) as shown in **cyan** in the photo above – the 2 holes should be on that line.

If they are not, fill the existing holes with flock and redrill them so that they are exactly 150mm from the rear of the stabiliser. This dimension will become critical later when you adjust the elevator travel so take the opportunity to check it (and adjust it if needed) now.

Remove the horizontal stabiliser and store carefully until required.

Fit the ventral fin

Use a chalk line to mark the fore and aft centreline of the fuselage.



Lay the ventral fin on the rear of the fuselage and seat it so that it matches the curve of the fuselage, then check that the fin is centred at the front and the rear and tape it in place. Drill $3/16$ " holes through each of the marked locations in the ventral fin mounting lip and through the fuselage. Remove the ventral fin then enlarge the holes in the fuselage to $13/64$ " and use a fluted wood drill bit (pictured right) to recess the hole so that the lip of the insert sits flush with the surface and then tap each hole to a $1/4$ " UNC thread.

Use a screw and spacer (shown above right) as a tool to place each insert. Before fitting the insert put a single drop of super-glue onto the outside thread and then screw it into place.



Fit the trim horn

Sand away any remaining gel coat and roughness from around the trim horn mounting area. The trim horn is slightly offset from the fuselage centreline so it will be necessary to sand the foot of the trim horn so that it will sit completely upright when it is mounted. Sand the sides of the trim horn at the same time so that the glass fibre cloth will bond correctly.

Mix up a small batch of 5-minute Araldite and flock and coat the foot of the trim horn, then place it on the marked line and use a length of tape to hold it upright. Put masking tape over the threaded inserts nearest to the trim horn to prevent flock getting into the threads.

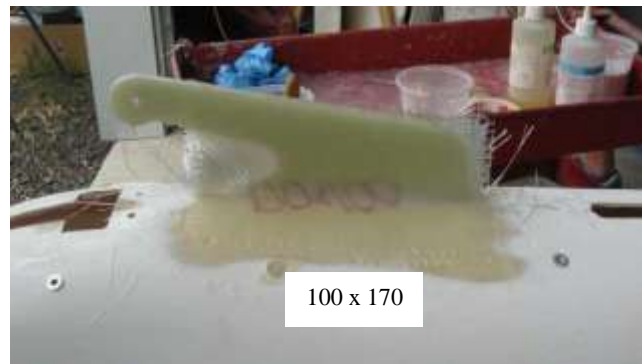
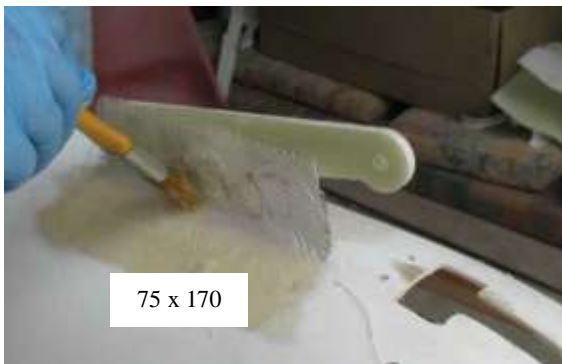

When the Araldite/flock mix has cured apply a small amount of resin and flock to make a smooth radius at the foot of the trim horn and then apply 3 layers of AF303 glass fibre cloth to each side of the trim horn. The bag labelled "Trim Horn" contains 2 sizes of glass fibre cloth: the larger pieces (100 x 170) go on the side nearest the fuselage centreline. Leave to cure overnight. The next day any excess cloth can be trimmed away with a sharp knife.

Finish the ventral fin

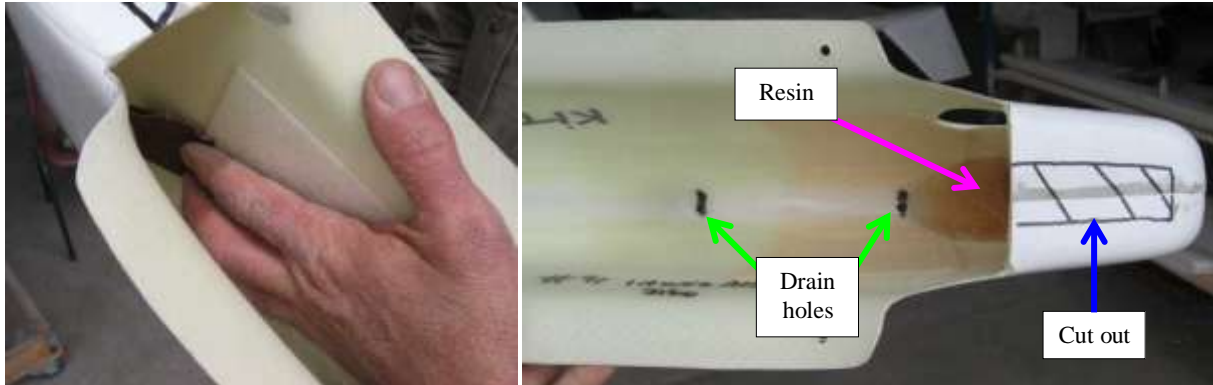

Sand the inside bottom rear quarter of the ventral fin. Mix around 200 grams of polyester resin and add a few drops of hardener (take care not to use too much hardener or there may be heat issues as it cures) and pour into the bottom of the ventral fin then prop the fin up at a 45° angle while it cures.

Once the resin has cured drill a 12.5mm hole through at the marked location – this will be your rear tie down point. Drill 2 drain holes, one at the front corner and one at the rear just in front of the resin.

Cut out the marked area at the top rear – this is where the elevator drive arm will travel.

Store the ventral fin for later final fitting and painting.

This completes the *Pre-Paint>Fuselage>Fit ventral fin and trim horn* task.

Pre-Paint>Fuselage>Prepare the fuselage

Objectives of this task:

Once the *Fit ventral fin and trim horn* task has been completed the fuselage can be turned upright and the remaining penetrations made. This allows the bulk (but not all) of the mess to be made early in the build.

In the factory we place the fuselage in a jig at this stage, however you can achieve much the same result by placing a sawhorse or a similar platform or trestle under the cabin and a higher trestle under the empennage. Cover both of these items with some padding to minimise scratching the fuselage.

Large holes should be started with a pilot hole first to accurately place the hole and then be drilled out with a hole saw.

Slots should have each end drilled out first and then mark and use a jigsaw to join the holes.

Rectangular holes should have a hole drilled at each corner and then be marked and cut from hole to hole with a jigsaw. This practise will ensure accurate cuts with no sharply angular corners or irregular edges.

Tools and materials required:

Orbital sander and hand sanding blocks

Power drill with bits, 30mm and 2¼" hole saws

Jigsaw

Epoxy resin and flock

Q-Cell filler

5-minute Araldite

Sand the fuselage

Start by using your orbital sander to take any rough edges away: the moulding process can leave sharp edges and the occasional few glass fibre prickles, so take a bit of time now and remove all of these potential hand hazards before starting work. Fibreglass cuts are painful and you can do a lot to avoid them by careful preparation at this early point in the build.

Think of it as an investment in your comfortable building future.

Run your orbital sander lightly across every internal surface: around the door frames, seats, console, windows, etc and anywhere else that looks even slightly rough. There is no need to sand heavily; just a light scuff is all that is required. Use a few hand sanding blocks for any hard-to-get-at places.

Remove peel cloth

Remove the peel cloth from the vertical fin stub and around the rear of the empennage generally, including around the horizontal stabiliser opening.

Lightly sand around the edges of the areas under the peel cloth to remove any peel cloth threads that remain.



Vertical fin stub

The rudder cable passes from the empennage and through the fin stub as does the static line, VHF antenna cabling and strobe wiring (if you elect to have a tail strobe). All these items require access into and through the fin stub.

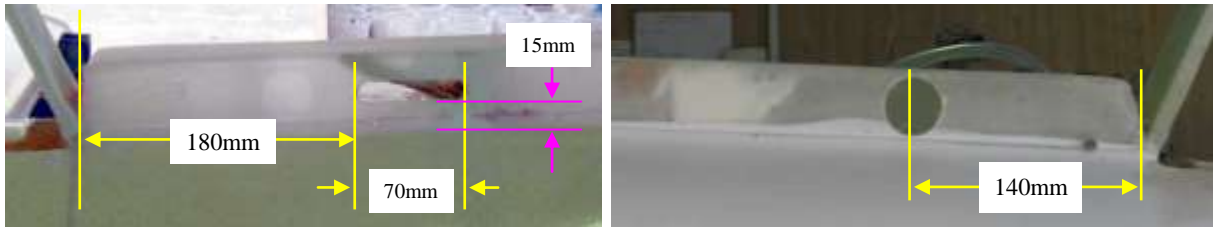

Start by marking and cutting the rudder cable slot on the right-hand side of the fin stub: measuring from the rear of the stub the slot starts at 180mm and is 70mm wide.

The bottom of the slot is located 15mm up from the base of the fin stub. Drill each end of the slot to 15mm and jigsaw the slot out, and then sand any rough edges away. Refer to the photo above left for detail.

The 30mm access hole on the left-hand side of the fin stub has its centre located at 140mm from the rear of the stub. Refer to the photo above right for detail.

The 30mm access hole in the top of the fin stub has its centre located at 30mm from the rear of the stub. Refer to the photo at right.

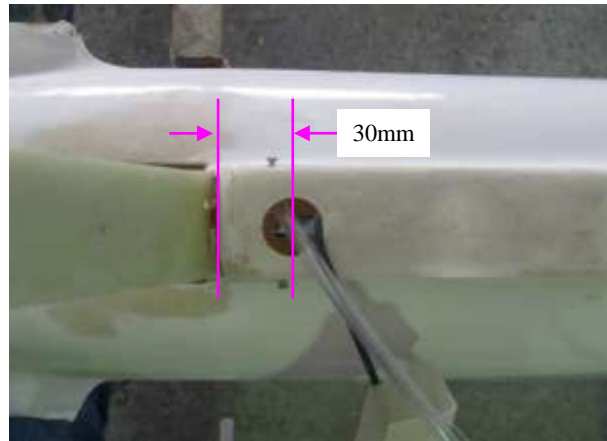

Cabin top penetrations

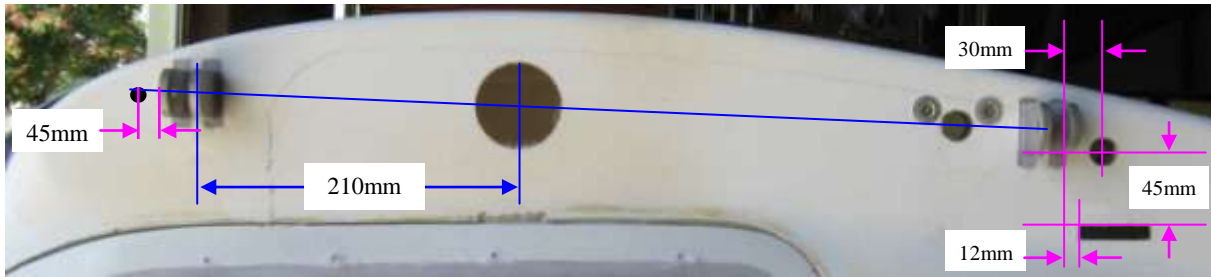

Mark a centreline between the bolt holes in the front and rear wing attach lugs: this will be the height of the centre of the fuel gauge opening.

Now double check the measurement marked “210mm” in the photos above and at right: measure in the wing root from the front wing lug back to the centre of the gauge as shown at right, then measure on the fuselage from the **inside** (not the outside) of the inner front wing attach lug (see photo above) the exact same distance (which should be very close to 210mm) then mark and drill the pilot hole for the fuel gauge opening. Recheck your measurements and then use a 2¼” hole saw to cut the gauge hole: drill a pilot hole first.

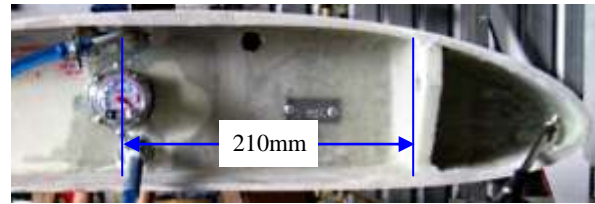

Measure forward 45mm from the front wing attach lug and drill a 10mm hole for the stall warning tube on the left side of the fuselage only.

To mark the fuel system connector slot, draw a line down 12mm from the back of the rearmost wing lug and another line 45mm below the bottom of the rearmost wing lug, and then mark the slot at 50mm wide and 10mm high. Drill both ends to 10mm and use a jigsaw to cut between the holes. File the top and bottom of the slot to a smooth and square finish.

Cabin air vents

Cut a 60 x 44mm opening on each side of the lower forward fuselage.

The bottom of the opening should be 80mm above the bottom of the door opening and the fore and aft location should be centred on a vertical line drawn down from the rear of the upper cowl joggle, all as shown at right:

Corners of the opening should be rounded to suit the vent door – the door should fit towards the front of opening with a 3mm gap at the rear to allow for the hinge action.

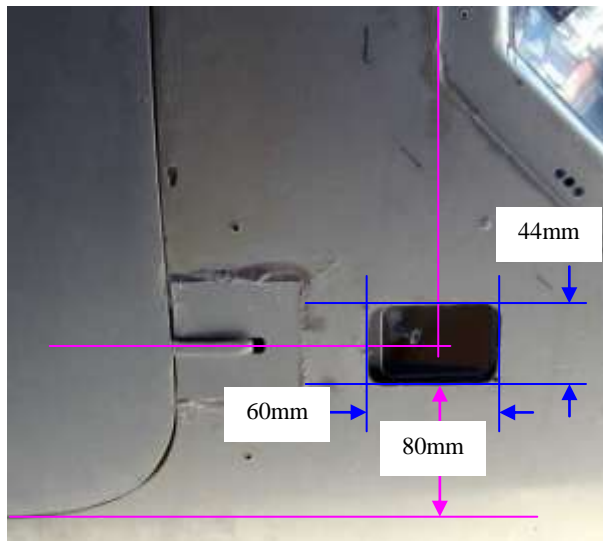

The air vent door surround can be flocked into place inside the fuselage as shown at right, with the hinge arm positioned at the rear of each hole and using the door to aid the positioning.



Fit the header tank enclosure

The fuel header tank sits behind the right-hand seat in a sealable enclosure and an additional rib is fitted to the left-hand floor rib so that the lid that seals the enclosure also functions as a luggage shelf behind the seats.

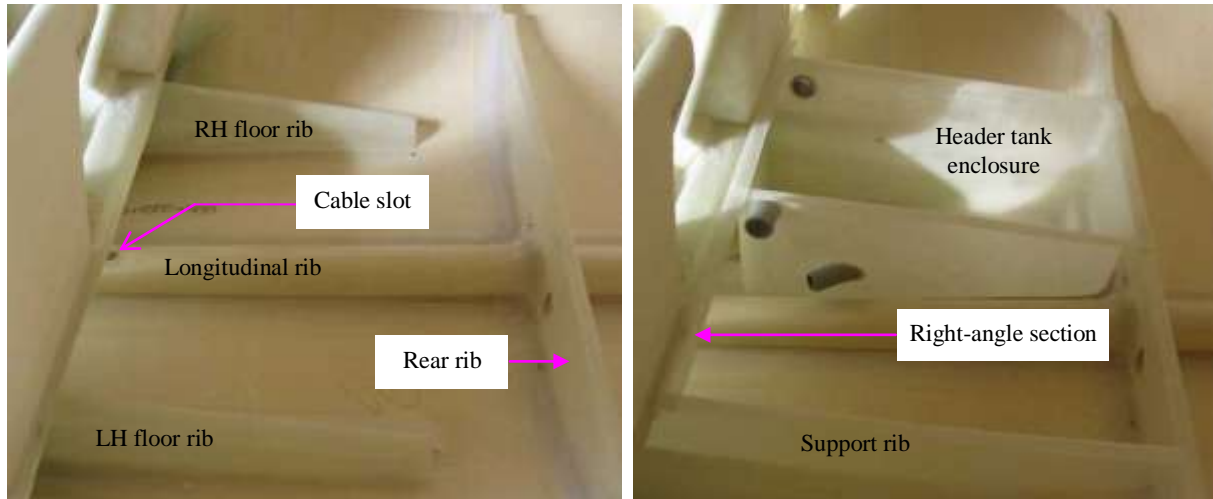

Place the header tank enclosure on the floor behind the right-hand seat so that it fits snugly between the longitudinal rib and the right-hand floor rib as shown above right and check that the rear lip of the enclosure sits down on the rear rib. Drill the 3 pilot holes in the enclosure (arrowed below right) at 3/32" through the fuselage floor and then remove the enclosure.

The drain from the enclosure will be through the quick-drain fitting hole.

Mix a batch of resin, stir in Q-Cell to make a firm mix and apply the Q-Cell to the cabin floor as shown in blue at right, including a circle with a clear centre of about 1½" around the quick drain hole. Apply the Q-Cell thicker towards the rear.

Refit the enclosure and secure with 3 x 8G self-tapping screws and washers: tighten the quick drain (front) screw so that the enclosure sits firmly against the floor but only tighten the rear screws enough to bed the enclosure firmly into the Q-Cell mix.

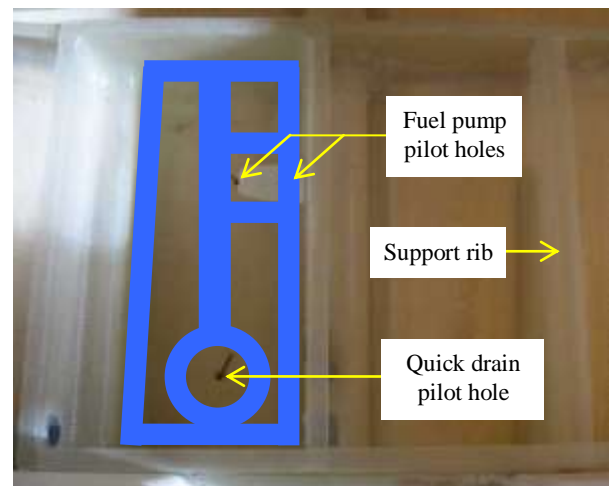

Cut the front of the support rib off so that it runs straight down from the rear of the seat to the floor, then pre-fit it inside the left-hand floor rib and make sure that the top of the support rib is level with rear rib and the cross beam behind the seats. Araldite a length of split tube along the front edge of the rib to protect fuel lines and cabling that will later pass in front of it.

Mix some resin and flock and fit the support rib into place and then fit the long right-angle section of glass fibre to the cross beam behind the seats as shown top right and above. Make sure that the top front of the enclosure is sealed and leave to cure overnight.

Next day trim the ends of the right-angle section to size, remove the 8G screws (heat if required) then drill the quick drain hole out to 1 1/8" and the fuel pump holes to 3/16".

Use TLR rivets to fix the tie-down lugs to the floor ribs as shown on the drawing overleaf.

THIS DRAWING IS COPYRIGHT AND MUST NOT BE COPIED WITHOUT CONSENT OF AVTECH PVTY LTD

DIMENSIONS IN MILLIMETRES

DO NOT SCALE

PROJECTION

⑦ ANGLE ATTACHED LEVEL WITH OTHER ENCLOSURE'S SIDE USE 5 MINUTE ARALDITE.

Q-CELL BED TO GLUE ENCLOSURE

SEW POSITIONS TO HOLD ENCLOSURE LID/LUGGAGE SHELF DOWN.

AREA TO BE SEALED SEAL AROUND HOLES WITH Q-CELLS

5 MINUTE ARALDITE ANGLE PART 7 ACROSS SEAT BACK FOR LID SUPPORT.

SECTION VIEW A-A

JOIN LUGGAGE SHELF SUPPORT END TO OTHER SIDES AND CROSS BEAMING 2 LAYERS 50MM AT 31.2 FIBREGLASS TAPE, WHERE POSSIBLE USE 1 LAYER EACH SIDE.

ATTACH USING TLR RIVET THROUGH FLOOR RIB

REAR HEADER TANK ENCLOSURE RIB

HEADER TANK COVER/LUGGAGE SHELF.

TIE DOWN LUG

SECTION VIEW B-B

ENCLOSURE LID/LUGGAGE SHELF HELD DOWN BY 8C SELF TAPPERS

TIE DOWN LUG P/N/No. 4008094

FOAM

Q-CELLS

SEAL LID ON TO ENCLOSURE USING 10MM WIDE TESLA ADHESIVE FOAM

PART No.	DESCRIPTION	Qty
1	1A057K00 J160 HEADER TANK ENCLOSURE	1
2	1A057H1D J160 HEADER TANK ENCLOSURE SIDE SUPPORT	1
3	1A057J00 J160 HEADER TANK ENCLOSURE LID	1
4	10MM WIDE TESLA TAPE SEAL	
5	PH0119N RIVET TLR 3/16 .18"-45 GRIP	4
6	4008094 LUG - FUEL TANK STRAP FRONT	4
7	1A057L00 J160 LUGGAGE SHELF SUPPORT ANGLE	1

NOTE:

1. "FLOOR" REFERS TO COTTON FIBRE FLOCK MIXED WITH RESIN TO A GLUEY CONSISTENCY. TYPICAL FLOCK FILLET RADIUS R6.
2. "Q-CELLS" REFERS TO Q-CELL FILLER MIXED WITH RESIN TO A GLUEY CONSISTENCY. TYPICAL Q-CELL FILLET RADIUS R6.
3. ALL RESIN TO BE LG3800 EPOXY UNLESS SPECIFIED OTHERWISE.
4. ALL MATERIALS TO PS&E-07.

DM	3	18/1/06
DM	2	15/4/05

SCALE	VAR	ISS.	NO.	DATE
	1	15/2/05		

AVTECH PVTY LTD HINKLER AIRPORT BUNDABERG

J160 FUSELAGE - VIA HEADER TANK ENCLOSURE STRUCTURAL DETAILS

DWG. NO. 1A057A0D-3

SHEET 1 OF 1

This completes the *Pre-Paint>Fuselage>Prepare the fuselage* task.



Pre-Paint>Fuselage>Undercarriage>Assemble main wheels

Objectives of this task:

In this task you will assemble the main wheels and tyres and fit the brake discs.

Materials required:

Cards # J21 'Main wheels'

Talcum powder for fitting the inner tube

Assemble the main wheels

Use a press or a vise to press the bearings into the main hub – use a socket with a slightly smaller diameter than the outer race of the bearing to press the bearings in with.

The outer bearing will sit slightly inside the hub while the inner bearing will be flush.

Do **not** press on the inner race – the bearing is not designed to take pressure in that direction.

Sprinkle some talcum powder inside the tyre and insert the inner tube. Slightly inflate the inner tube to prevent it becoming pinched then fit tyre and tube over the main hub and fit the outer rim to the main hub with the inner tube inflation valve facing out.

Bolt the outer rim to the main hub, but before tightening the bolts make sure that the inner tube is not being pinched by rotating the tyre and tube while holding the wheel still.

Fit the inner tube inflation valve through the hole in the outer rim and then tighten the bolts holding the outer rim to the main hub. Inflate the tube to a pressure of 30psi – the tyre will pop out to the final seated position on the rims so keep fingers away while inflating.

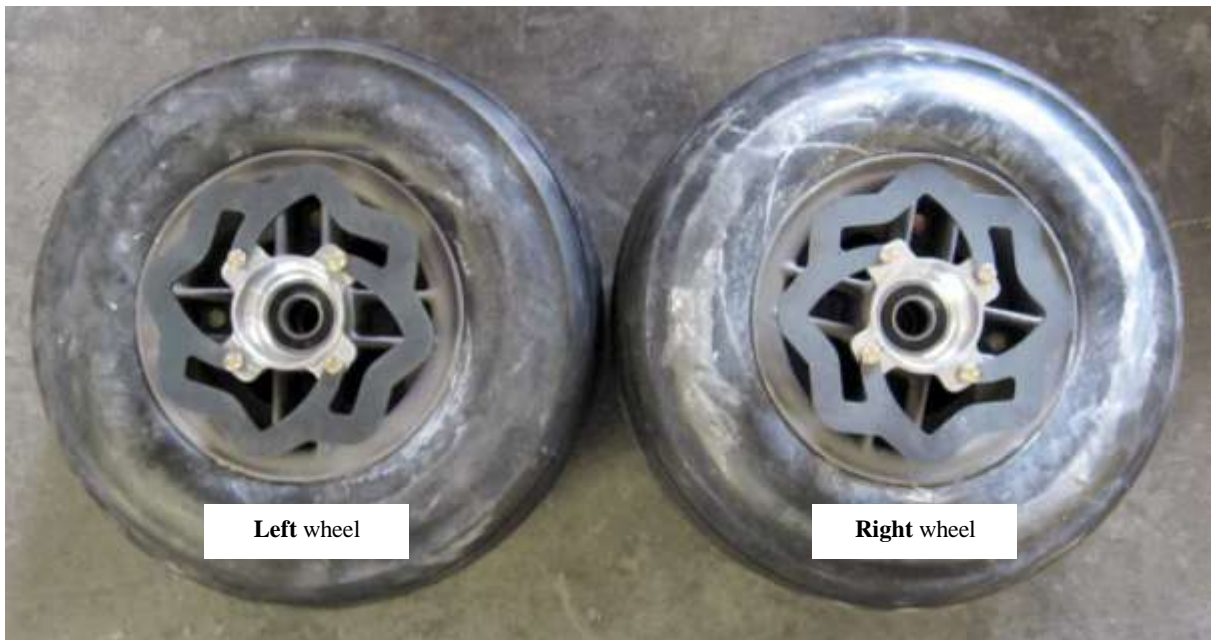

Fit the brake disc to each wheel. It is important that each disc is fitted in the correct direction of rotation as shown in the photo above and in the drawing on the next page. Fit each AN3-6A bolt though from the disc towards the wheel as shown above and secure with an AN960-10 (3/16”) flat washer and Nyloc nut and tighten firmly.

Use chalk to mark each wheel as being either a left or a right wheel.

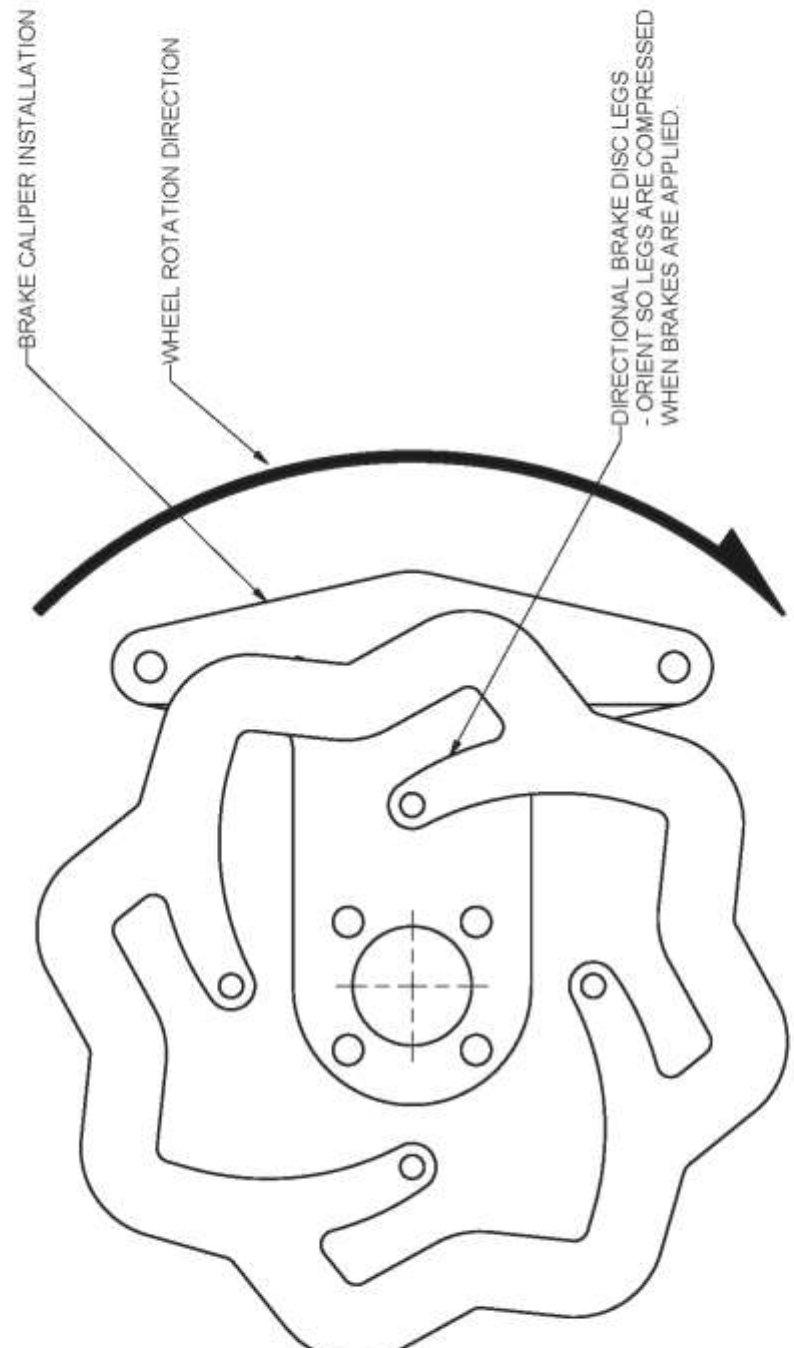

NOTE: "WAVY" DISC SHOWN WITH SINGLE BRAKE CALIPER. SAME ORIENTATION APPLIES WITH DUAL CALIPER SYSTEMS. DISC LEGS MUST BE ORIENTED TO BE COMPRESSED WHEN BRAKES ARE APPLIED.

PROJECTION		DIMENSIONS IN MILLIMETRES	DO NOT SCALE	AVTECH P/L A.C.N. 010 786 973 HINKLER AIRPORT BUNDABERG 4670	THIS DRAWING IS COPYRIGHT AND MUST NOT BE COPIED WITHOUT THE CONSENT OF AVTECH PTY LTD	SCALE NTS	1 ISS	8/11/05 DATE
GENERAL TOLERANCES WHOLE NO.'S ± 0.5 ONE DEC. ± 0.25 TOW DEC. ± 0.05 ANGLES ± 0.5°	DRAWN DS	APPR.	TITLE DIRECTIONAL BRAKE DISC INSTALLATION.			DWG. No. 6A037A0D-1		
MATERIAL N/A				SHEET 1 OF 1			A4	

This completes the *Pre-Paint > Fuselage > Undercarriage > Assemble main wheels* task.

Pre-Paint>Fuselage>Undercarriage>Assemble main gear

Objectives of this task:

In this task you will assemble the main undercarriage legs, which includes fitting the axles, disc brakes and wheels and adjusting the brakes.

Materials required:

Cards # J8 'Dual Brakes' and J21 'Main wheels'

Brake fluid for assembly of disc brake pistons

Spat brackets

Fit the retained nuts to the spat mounting brackets using countersunk 3/32" rivets. There are 4 retained nuts (arrowed) on each bracket. Countersink the actual screw holes where the spat will be fitted: the countersinks will help to guide the screws into the holes when fitting the spats.

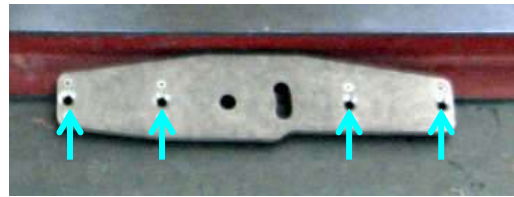

Fit the axles and backing plates

Slip the stub axle (from the 'Main wheels' card) through the mounting plate with the brake unit facing towards the front of the aircraft and fit to the main gear leg as shown in the photo at right. The chamfered face of the plate is on the side that faces the gear leg.

Align the bolt hole in the outboard end of the stub axle (arrowed in green at right) vertically and fix the plate in place 2 x AN5-16A bolts at the top and 2 x AN5-15A bolts at the bottom. The longer bolts are used at the top to allow for the spat bracket.

Fit the spat bracket to the AN5 bolts with the captive nuts facing towards the wheel and with the notched surface to the bottom as shown below right.

Fix in place with one Nyloc nut and washer on the top front bolt.

The gear leg shown in the photos on this page is a right-hand gear leg.

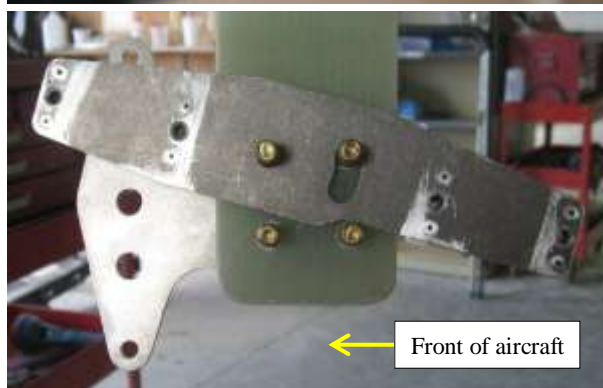
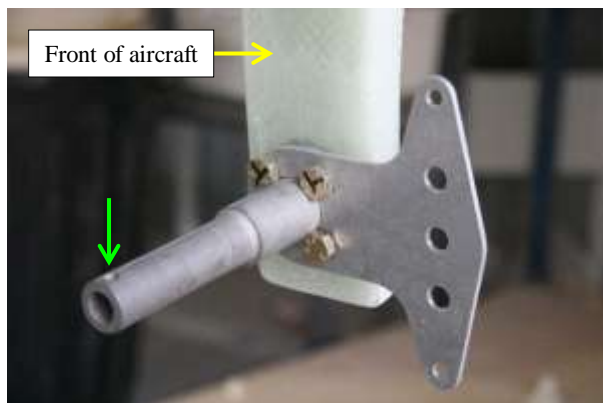

Fit Nyloc nuts and flat washers to the 2 bottom bolts and a Nyloc nut with a penny washer to cover the adjustable slot at the top rear bolt. This slot will allow the spat to be moved up or down during final assembly. The slot must face the rear of the aircraft.

Check that the bolt hole in the outboard end of the stub axle is positioned up and down before tightening the nuts firmly.

Use a permanent marker to identify each leg as being either a right or left leg at this point – it can save confusion when you come to fit the gear legs in the next task.

Assemble the brake pads

Fit the brake pads to the backing plates: there are 2 types of backing plates – flat and U channel.

Both types take the same pads, but the shorter rivets are used on the flat backing plate.



Face the angled side of the pad to the outside of the backing plate as shown in the photo of completed pads below right. Each brake pad is held in place by 3 rivets and the fitting process is as follows: fit all 3 rivets from the recessed hole in the pad through the pad and through the backing plate. Note that fitting the third rivet may need a slight touch with a drill to ease the rivet through the last hole.

Seat the rivets by tapping the heads to make sure that each rivet is fully through the pad and the backing plate, then turn the assembly over and rest the head of the rivet on a protrusion* and flare the rivet using a tapered punch then use a flat punch to mushroom the end of the rivet over. The rivets should not be able to move when correctly fitted.



*In the factory we use a simple jig that holds the backing plates over studs at each end and has 3 raised screws to hold the rivets up – you can see it in the riveting photos above.

You could make up something similar in your workshop by screwing 3 screws into a solid wooden bench (use a backing plate for the spacing), all at the same height so that the brake pad just clears the bench and the head of each screw touches the head of each rivet, then place each brake pad and backing plate over them and use them to punch against.



Check each brake pad and backing plate assembly carefully to see if there are any cracks in the pad, particularly around the end rivet holes. If there are any cracks call your dealer for a replacement pad and rivets: do **not** fit a cracked brake pad.

The brake pad and backing plate assembly will be referred to as simply a *pad* from this point on. The U channel pad is the *outer pad* and the flat plate pad is the *inner pad*.

Assemble the brake calipers

In this step you will assemble the hydraulic disc brake calipers.

Cleanliness is essential when working with hydraulic brake parts, so clean your working area and your hands thoroughly before starting this step.



Use compressed air to clean any dust and dirt from the inside of the brake calipers and pistons. Apply brake fluid to the O-rings and fit one to each piston, then apply a smear of brake fluid to the inside of the caliper and fit the pistons to the calipers: press the piston gently into the caliper with the cupped side of the piston facing outwards.

Thread and tighten a bleed nipple into the lower fitting on the caliper (*under* the Jabiru logo) and push a blanking plug into the top fitting as shown at right – the brake lines will be fitted later in *Post-Paint* and the blanking plug will keep the caliper sealed until then.



Wash any brake fluid off your hands with soap and water – it can irritate sensitive skin.

Refer to the drawing on the next page for an overview of the brake system.

NOTE:

- RIGHT SIDE ASSEMBLY SHOWN P/Ns. 6207023.
- LEFT SIDE OPPOSITE P/Ns. 6207024.
- BRAKE HOSE STUD NOT SHOWN. ENSURE 3.0-3.8mm OF HOSE PROTRUDES THRU FERRULE.

Parts List

ITEM	PART NUMBER	DESCRIPTION	QTY
1	6207124-5	INTEGRAL 1.25" CYLINDER BRAKE CALIPER.	1
2	A22-03	BRAKE FITTING	1
3	8100094-4	NIPPLE BRAKE BLEEDER	1
5	6000694-3	BRAKE PAD	1
6	6A015F00-4	BONDED (OPT) BRAKE PAD OUTER MOUNTING PLATE	1
7	PD0062N	3/16" FERRULE (NYLON BRAKE LINE)	1
8	RV0214	O-RING	1
9	RT20	RIVET	6
11	AN4-14A	BOLT	2
12	AN60-416	1/4" FLAT WASHER	2
13	PX0026N	BRAKE SPRING	2
14	6207224-6	1.25" BRAKE PISTON	1
15	MS21045-42B	1/4" HIGH-TEMP LOCK NUT	2
16	6A016A00-2	1.5" BONDED BRAKE PAD ASSY	1
17	6A015D00-3	MOUNT PLATE - 1.5" BRAKE CYLINDER	1

SECTION B-B. SCALE (1:1)

DS	3	11/2007	SCALE	1	23/8/02
DM	7	25/5/04	VAR	ISS.	DATE
THIS DRAWING IS CONFIDENTIAL AND MUST NOT BE COPIED WITHOUT THE CONSENT OF AVTECH PVT LTD.					
TITLE: INTEGRAL 1.25" CYLINDER BRAKE CALIPER ASSY					
			AVTECH P/L A.C.N. 010 786 973 HINKLER AIRPORT BUNDABERG 4670		
			DO NOT SCALE DRAWN DS APPR.		
			DIMENSIONS IN MILLIMETRES LIMITS UNLESS SPECIFIED OTHERWISE: ± +0.5		
			PROJECTION REFER TO PART DRAWINGS.		
			MATERIAL		
6207023-3 SHEET 1 OF 1 AS3					

Assemble the brake and wheel

Firstly and very importantly place the alloy washer (#6A028B0D on the 'Main wheels' card) on the stub axle with the tapered inner side **towards** the gear leg and **away** from the wheel – this washer (circled at right) provides a square surface for the inner wheel bearing to butt up to.

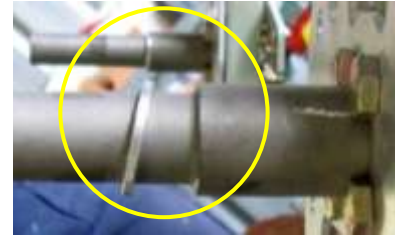

Now we can fit the appropriate wheel (left or right) to each gear leg and then fit the brake system.

Fit the wheel to the stub axle and secure with the axle extension, fitting an AN3-12A bolt through the extension and the axle from the top with a lock nut on the bottom.

Take the U channel backing plates and the steel lock nuts. Fit a bolt through the backing plate from the pad side and into the nut and very carefully apply a drop of Superglue to 2 opposite flats of the steel lock nut and then pull the steel lock nut back into the U channel as shown arrowed at right to glue the nut into the U channel:

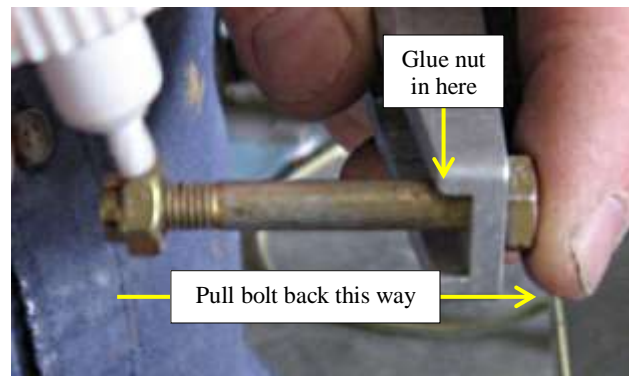

Take care not to glue the bolt into the nut!

Look carefully at the drawing on the previous page to see how the brake assembly fits together.

As you can see from the drawing the outer pad goes on the outside of the wheel disc, while the inner pad goes between the wheel disc and the brake mounting plate and the hydraulic caliper goes behind or inboard of the inner mounting plate.

2 AN4-14A bolts, each with a washer, secure the whole assembly and each bolt has a spring that is fitted over the bolt and which holds the brake pads apart. In the factory we fit the top bolt first with no spring in order to get the correct alignment and then fit the bottom bolt and spring, then go back to the top bolt and fit the spring.



Adjust the brakes

The objective is to have a wheel that will turn freely while at the same time not having the brake pads too far away from the disc.

In order to achieve this it may be necessary to slightly bend the brake mounting plate away from the disc – loosen the main bolts just enough that the outer pads are 1 or 2mm away from the disc and check just the clearance between the inner backing plate and inner pads.

If the inner pad is rubbing and making it difficult to turn the wheel, gently bend the brake mounting plate slightly away from the disc until the wheel can turn freely but with the pad just touching the disc.

Now tighten the main bolts up until the outer pad just starts to bind on the disc and then back the bolts off slightly, perhaps one third to one half of a turn. At this point the wheel should turn freely and the brake pads should still be very close to the disc.

In the photo at right you can see the finished brake assembly, fully adjusted.

Note that there is very little clearance between the disc and the brake pads.

Note also the springs on the bolts that hold the pads apart.

At the left of the photo you can see the spat bracket with the captive nut visible.

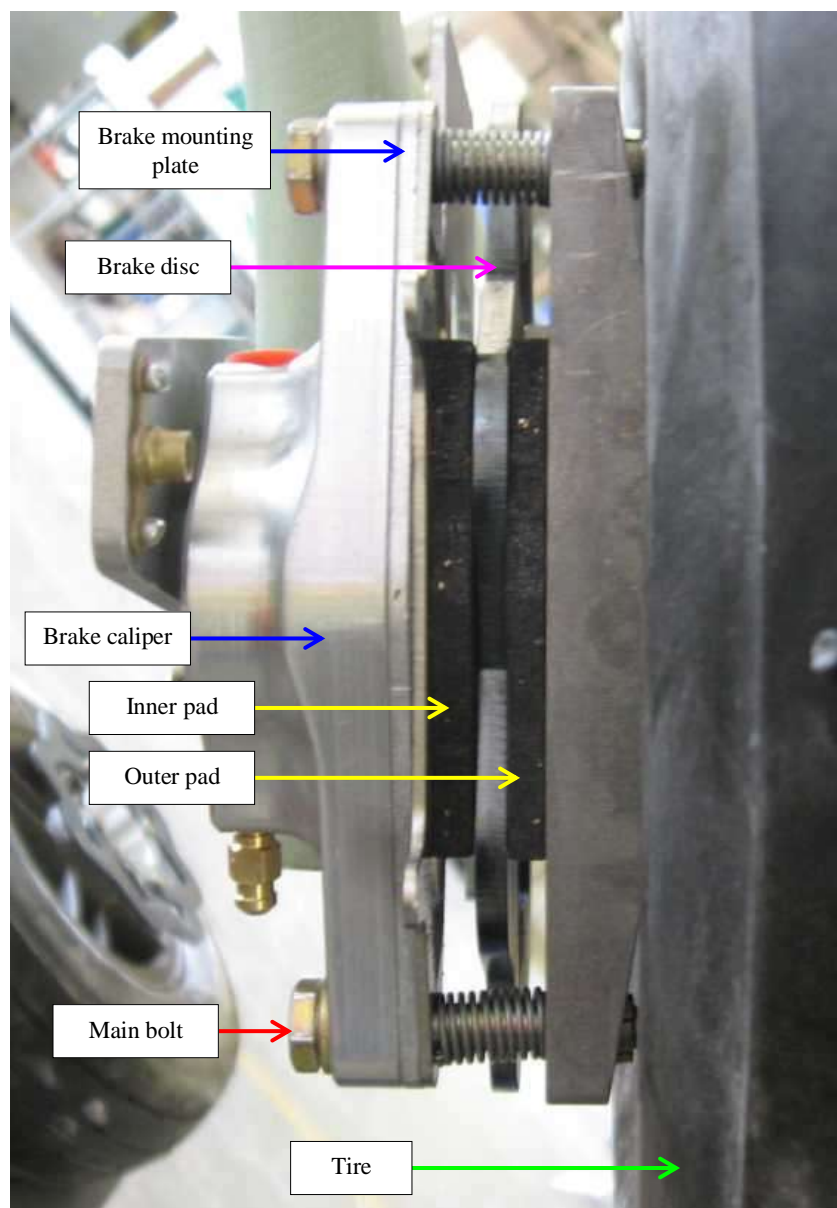

This completes the *Pre-Paint>Fuselage>Undercarriage>Assemble main gear* task.

Pre-Paint>Fuselage>Undercarriage>Fit main gear

Objectives of this task:

In this task you will permanently fit the main undercarriage to the fuselage. Both main gear legs will be fitted to the fuselage at the same time and the mounting bolt reinforcing plates will be flocked to the cabin floor as part of the fitting process.

At this point in the build the fuselage should be upright and firmly mounted on 2 trestles that place the underside of the fuselage at 650mm high under the cabin.

A standard builders sawhorse placed in front of the main gear recess would provide adequate clearance.

Materials required:

Card # J7 'Undercarriage'

Epoxy resin and flock

10mm / 3/8" ID reinforced hose approximately 80mm long:



Prepare and pre-fit the main gear legs



Fit the centre bolt to the inboard end of each leg: the AN6-24A bolt (the shortest 3/8" bolt on the Card) goes through a flat washer, a machined aluminium washer and 2 rubber bushes, with the rubber bushes fitting into the gear leg as shown above left and centre.

Fit the gear leg into the recess in the fuselage and fit the bolt up through the inner hole in the gear leg recess as shown above right. Place a Nyloc nut loosely on the thread for the moment. Cut out the yellow packers for the clamp plate and drill 3/8" holes in each end as marked – use the clamp plate as a drilling jig.

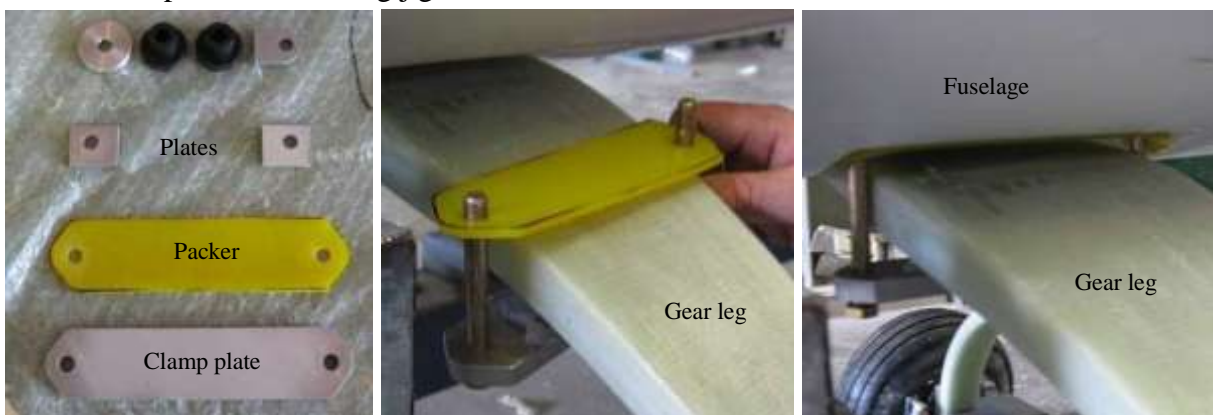

Assemble the clamp plates: fit 2 x AN6-26A bolts and washers to the clamp plate then fit the yellow clamp plate packer to one bolt only.

Fit the assembly around the gear leg then fit the yellow clamp plate packer to the other bolt and test fit by fitting the bolts up through the holes in the fuselage.

Use a pencil to mark the position of the clamp plate on the top and bottom of the gear leg – the clamp plate will be flocked onto the gear leg and the marks indicate where you will need to roughen the gear leg in order to provide a key for the flock.

Remove the clamp plate; roughen the top of the plate and the marked areas on the top and bottom of the gear leg.

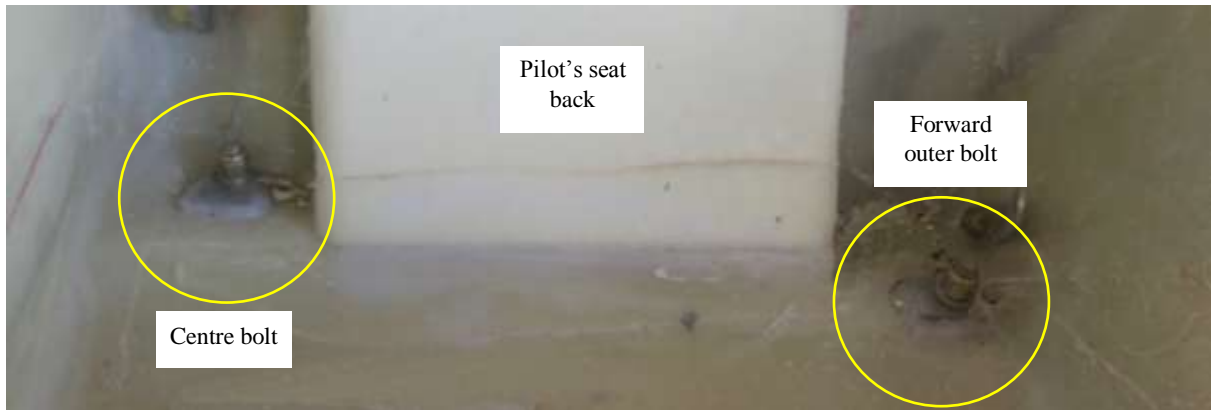

On each side of the front seats are the centre and forward outer clamp holes for the main gear, while the rear outer clamp hole is on the floor behind the main beam, and each hole will have a reinforcing plate flocked over it. (The plates are on the Card, part numbers 6036094 and 6037094, and can be seen the lower left-hand photo on the previous page.)

Roughen the area around each hole and the back of each reinforcing plate to provide a key for the flock. The surface around each hole is not absolutely flat, and no attempt should be made to make it flat because doing so would require removal of glass fibre from the floor which could weaken the area.

Fit the main gear legs

Mix a batch of resin, keep a small amount aside and add flock to the remainder.



Apply a 2mm layer of flock to the top of the clamp plate and reassemble the clamp plates: fit 2 x AN6-26A bolts and washers to the clamp plate then fit the yellow clamp plate packer to one bolt only.

Fit the assembly around the gear leg then fit the yellow clamp plate packer to the other bolt and fit the bolts up through the holes in the fuselage.

Push the gear leg firmly up against the fuselage and use a soft-headed hammer to drive the clamp bolts and centre bolt fully home.

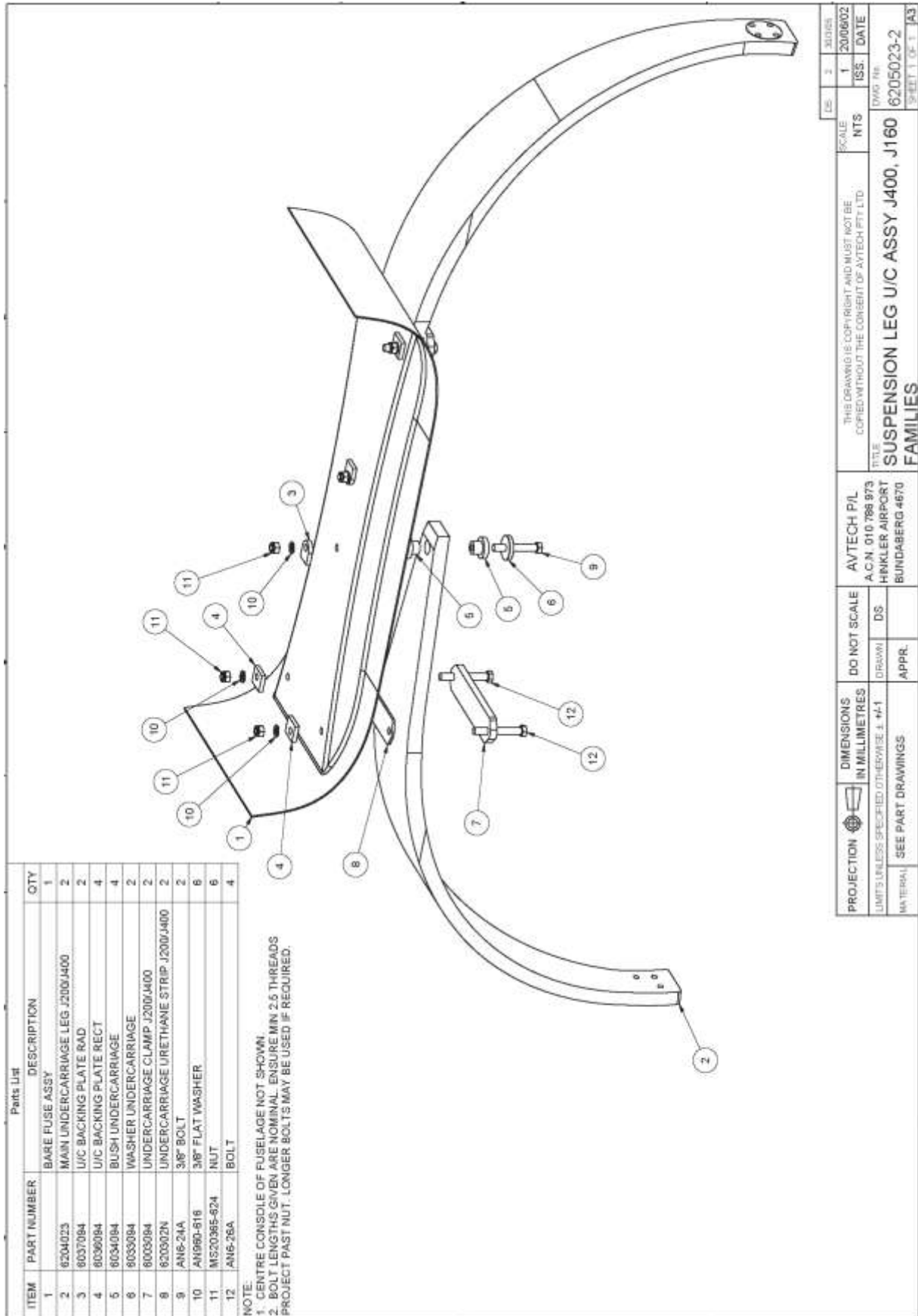

Parts List

ITEM	PART NUMBER	DESCRIPTION	QTY
1		BARE FUSE ASSY	1
2	6204023	MAIN UNDERCARRIAGE LEG J200/J400	2
3	8037084	U/C BACKING PLATE RAD.	2
4	8036084	U/C BACKING PLATE RECT	4
5	8034084	BUSH UNDERCARRIAGE	4
6	8033084	WASHER UNDERCARRIAGE	2
7	8003084	UNDERCARRIAGE CLAMP J200/J400	2
8	620302N	UNDERCARRIAGE URETHANE STRIP J200/J400	2
9	AN6-24A	3/8" BOLT	2
10	AN6-24A	3/8" BOLT	6
11	MS20365-924	NUT	6
12	AN6-26A	BOLT	4

NOTE:
 1. CENTRE CONSOLE OF FUSELAGE NOT SHOWN.
 2. BOLT LENGTHS GIVEN ARE NOMINAL. ENSURE MIN 2.5 THREADS PROJECT PAST NUT. LONGER BOLTS MAY BE USED IF REQUIRED.

PROJECTION	AVTECH P/L A.C.N. 010 788 973 HINKLER AIRPORT BUNDABERG 4670	THIS DRAWING IS COPYRIGHT AND MUST NOT BE COPIED WITHOUT THE CONSENT OF AVTECH P/T LTD.	SCALE NTS	ISS. DATE 1 2006/02	DS 30085
DIMENSIONS IN MILLIMETRES	DO NOT SCALE	TITLE SUSPENSION LEG U/C ASSY J400, J160	DRAWN DS	DWG. NO. 6205023-2	SHEET 1 OF 1 A3
MATERIAL SEE PART DRAWINGS	APPR.	FAMILIES			

Fit the reinforcing plates

Cut 4 x short lengths (~7mm) of reinforced hose (cut square) and slip one over each centre bolt, then fit the curved reinforcing plates, roughened side down with the curved side facing outwards, followed by a flat washer and a Nyloc nut.

Fit the other short lengths to the forward outer clamp bolts and then cut 2 x 12mm lengths of reinforced hose and slip one over each rear outer clamp bolt, then fit each square reinforcing plate, roughened side down, followed by a flat washer and a Nyloc nut.

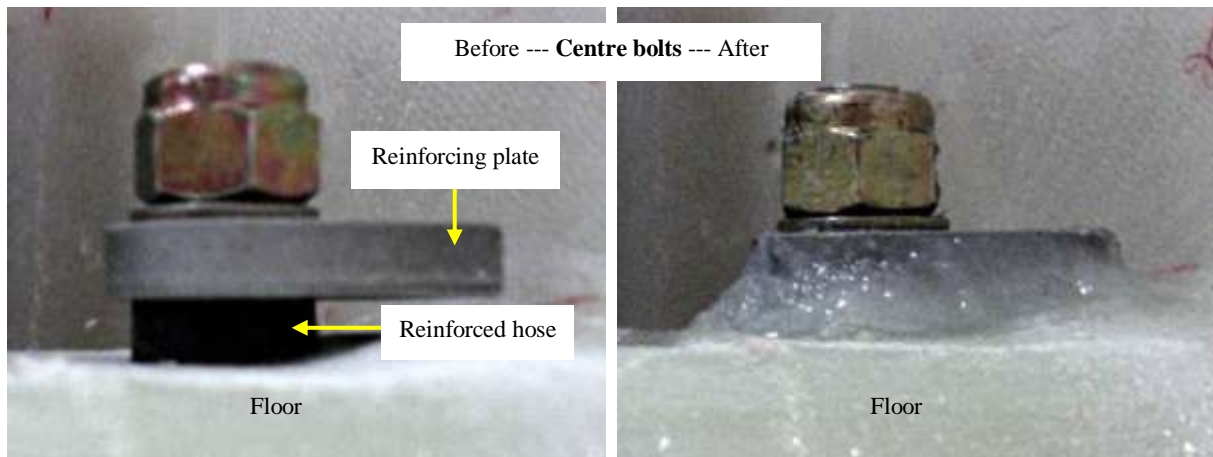

Tighten each nut until the first thread on the bolt is just visible above the top of the nut – at this point the bottom of the reinforcing plate will be very close to the cabin floor and the reinforced hose will be compressed to roughly half of its original thickness and will have formed to suit the shape of the floor so it will completely seal the bolt from any flock.

Tap each plate around until it is squarely aligned in relation to the console or the sides of the fuselage as appropriate.

The clamp bolt reinforcing plates have the holes drilled off-centre: the widest part of the plate should be closest to the higher part of the floor.

Brush some resin on the floor under each reinforcing plate and then pack flock in and around each plate until all voids are filled.

Use a clean mixing stick dipped in resin to smooth any excess flock from around the plates and also from around the clamp plates under the gear leg.

Leave overnight to cure.

Next day the clamp bolts can be tightened until 2½ threads protrude beyond the nut, which in turn will provide the required tension.

Tighten the centre bolts until the rubber bush between the gear leg and the aluminium washer has been compressed to half its original height.

The main gear is now permanently fitted to the fuselage and the saw stool or trestle can be removed from beneath the cabin, however the trestle that is supporting the tail of the aircraft will need to remain in place until the nose wheel and engine have been fitted.

This completes the *Pre-Paint>Fuselage>Undercarriage>Fit main gear* task.

Pre-Paint>Fuselage>Firewall forward>Fit firewall

Objectives of this task:

To fit the stainless steel firewall plate to the fuselage. This task will require accurate measuring and bending of the firewall plate: it is possible to make an accurate bend by clamping the plate to the edge of a solid workbench between 2 lengths of heavy angle iron and use a solid length of timber or heavy angle iron to press the bend to a tight radius, but for a small fee many plumbers or sheet metal shops will bend the firewall plate for you, and provided that your markings are accurate this may be a good choice for many builders.

Note that the bends required are not sharp creases but rather tight radius (3mm) bends of 55°, which is the same type of bend that a plumber's sheet folder will make.

Materials required:

Firewall plate (stainless steel)

Dow Corning silicone sealant (dark green tube in kit – shown above right)

Firewall insulation sheet (white roll in kit – shown at right)

38 x 73 AS 5/32" rivets and matching washers



Mark and bend the firewall plate

The technique that we use in our factory is to temporarily mount the firewall near the lower bend with 2 self-tapping screws and mark the centre of the bend points, then bend the plate.

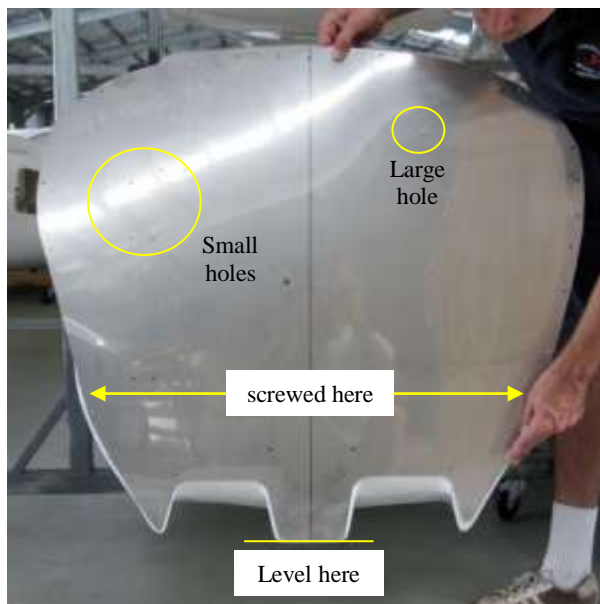

Start by having someone help you to position the plate so that the bottom centre of the plate is level with the bottom of the fuselage and the plate is equally spaced side to side. It is important that the plate is positioned the right way around: the small holes must be in the upper left and the larger hole must be in the upper right when viewed from the front. Refer to the photo above left as an example of the correct positioning.

Drill a 3/32" hole through the plate and into the plywood firewall each side (as arrowed in the photo at above left) and fit a self-tapping screw, then mark the **centre** of the lower bend on each side (as circled at above right). Bend the plate slightly back at the lower bend as a reminder of the correct bend direction for later when you bend the plate.



Measure from the centre of the lower bend back to the centre of the upper bend on the fuselage and transfer that measurement to the firewall plate – note that the measurement may be slightly different from side to side so measure each side independently. Recheck your measurements and then remove the plate, transfer the lower bend marks to the back of the plate and take the plate to the bender.

It is particularly important that the bends are made in the correct direction: the lower bend should take the plate towards the rear of the aircraft while the upper bend should take the plate upwards, parallel to the lower part of the plate. Take care to make the bends in the correct sense – the plate *cannot* be reversed if the bends are made backwards.



These photos show the upper bend being made and the plate sitting in place. In our factory the bending process takes a skilled person about 15 minutes – it is not a complicated task so long as you take care to measure accurately and bend carefully and in the correct sense.

Fill the lower plywood firewall

Due to the moulding process there may be a slight depression in the lower centre of the plywood firewall where the nose gear will be mounted. Mix 80 grams of flock and apply to the area, then use the side of a mixing stick to level the area as shown at right.



Fit the firewall plate

Run a 1/4" drill through the engine mount holes in the upper firewall (shown circled in the photo below left). This will make fitting the top engine mount much easier.

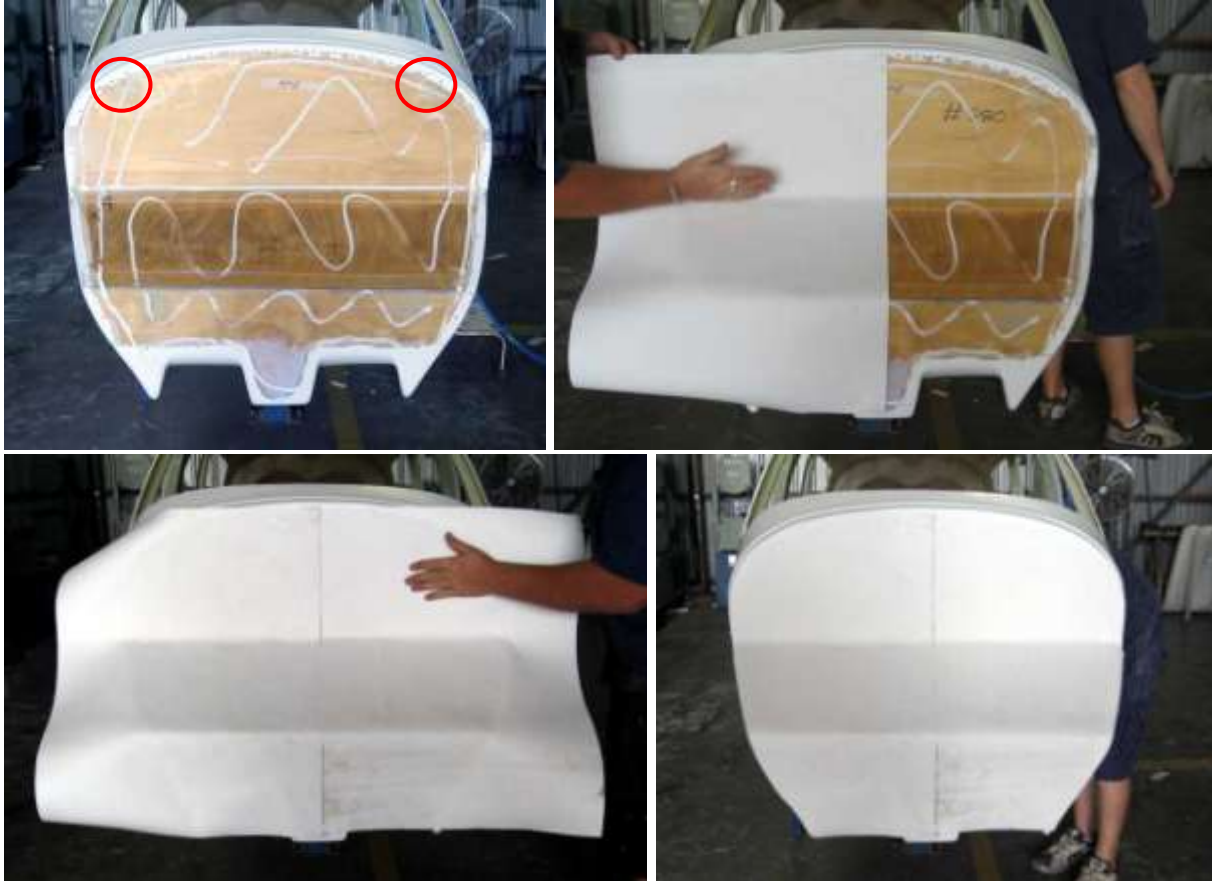

Apply a generous bead of the Dow Corning silicone sealant about 1" in from the edge of the plywood firewall all the way around the perimeter and also in a zigzag pattern across the firewall and then lay one insulating sheet onto the plywood firewall to the midpoint of the firewall so that it is held by the sealant. Lay the other sheet and butt up to the first sheet in the middle of the firewall. Pat the sheet into place and then cut to size with a sharp knife.



Apply the Dow Corning silicone sealant to the back of the firewall plate in the same manner: around the outside and across the rest of the back, then place the plate onto the insulating sheet and push firmly into place using the lower part of the firewall sheet as a reference. Secure temporarily with 2 self-tapping screws at the base of the upper bend on both sides and 2 more in the holes just below the upper bend.

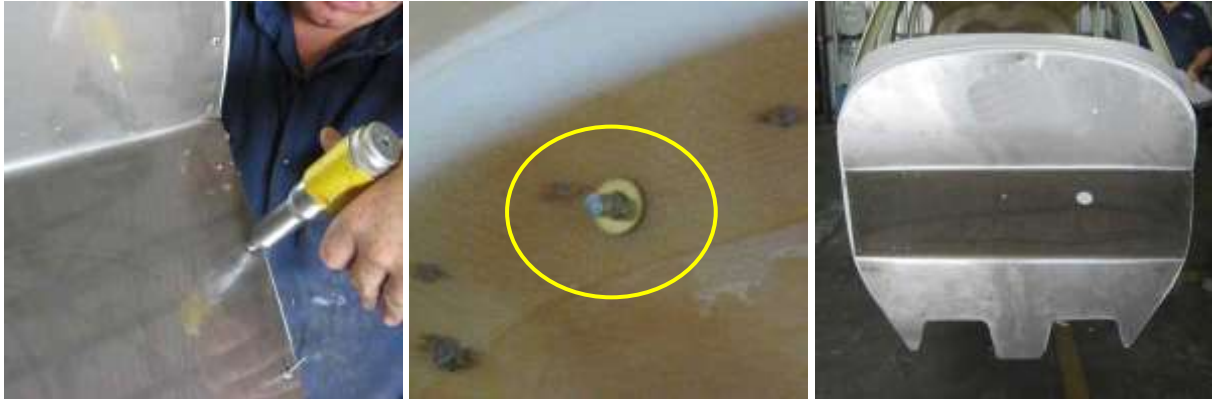

Once the plate is held in place in this manner you can start to fix it permanently with pop rivets, working carefully around the plate, drilling through the pre-drilled holes in the plate and through the plywood and taking care to always put a washer on the back of each rivet (circled above centre) – unless you have long arms you will probably need another person to help you with this step by holding the washers in place while you rivet.

Be particularly careful when drilling through the plywood firewall – if you push too hard then the drill can chip a section of ply out when it breaks through the back of the plywood, so drill using gentle pressure only.

Once the plate has been fully riveted into place use a sharp knife to trim away the insulating sheet from around the edges of the firewall plate.

Fit a temporary plate (plywood is fine, in the factory we use aluminium) across the lower centre of the firewall to hold the plate firmly against the flock filler. 3 screws (2 top, 1 bottom, arrowed) are sufficient to hold the plate in place overnight while the flock cures.

Next day remove the plate.

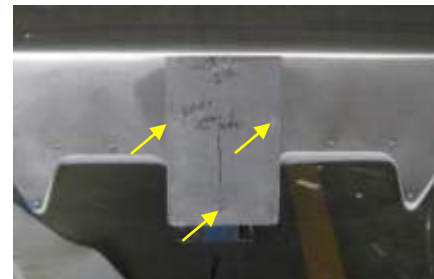

This completes the *Pre-Paint>Fuselage>Firewall forward>Fit firewall* task.

Pre-Paint>Fuselage>Firewall forward>Firewall fittings

General:

This task requires the drilling of several holes through the stainless steel firewall. Stainless steel is hard, and the best way to drill it is to use very sharp drill bits and drill very slowly: drill too fast and your drill bit will very quickly become blunt and the stainless will work-harden as well. For the larger holes you will need a hole saw and a few drops of cutting oil on the teeth will make the cutting easier, once again using a slow speed.

Materials required:

Card #'s J10 'Firewall', J11 'Fuel components', J25 'Cabin heater', Dow Corning sealant

Air box and cable collars

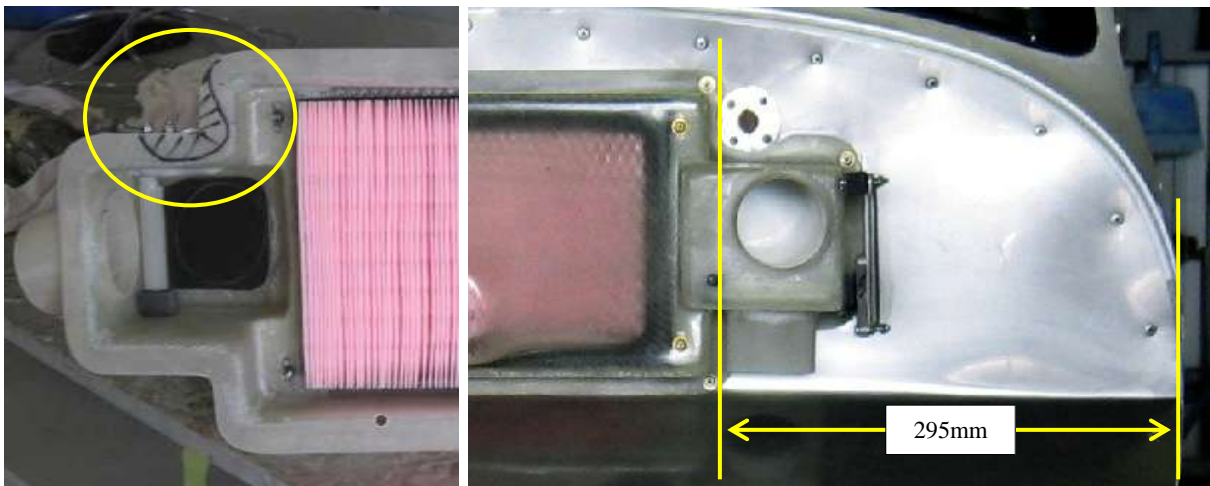

The air box needs to have a small amount ground out to allow for the cable collar: mark and remove the area indicated in the photo above left. Position the air box so that it sits flat on the firewall just above the upper bend, then measure in 295mm from the left hand edge of the firewall to the left hand main side of the air box. Check that the air box is level and then fix it in place temporarily with a strip of cloth tape along the top edge.

With the air box held in place, hold the cable collar in the ground out area as circled at above right and mark the centre of the collar. Remove the air box and drill a 22mm hole through the firewall for the cable collar then fit the cable collar with 6G stainless steel screws (drill 1/8" holes through the firewall plate only for these screws, they will self-tap into the plywood firewall).

Apply a bead of the Dow Corning sealant around the mounting surface of the air box and fix it in place with 8 x 5/32 pop rivets, 1 on each corner and 1 at top and bottom centre, with a washer on each side of each rivet (rivets arrowed in red).

Apply extra sealant around the cable collar so that there is a good seal with no possibility of air leaks.

Wipe away any excess sealant with a clean cloth.

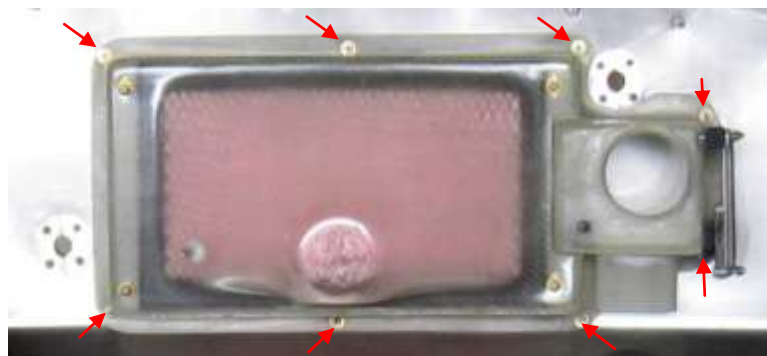



Fit the right hand cable collar: measure in 280mm from the right hand side of the firewall and up 60mm from the upper bend and drill a 22mm hole through the firewall then fit the cable collar with 6G stainless steel screws (drill 1/8" holes through the firewall plate only for these screws, they will self-tap into the plywood firewall).

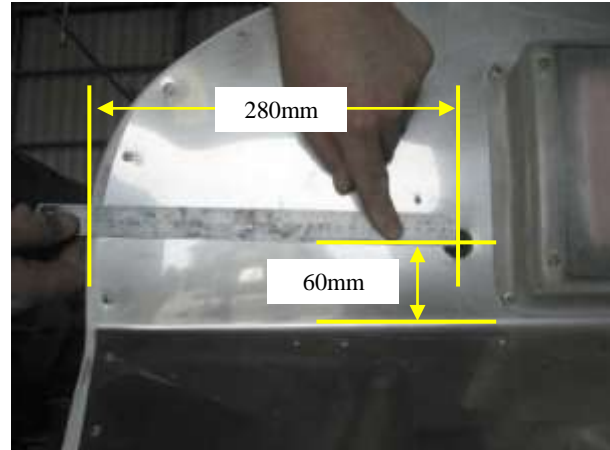

Battery box and battery



Run a 3/16" drill through the 2 pairs of holes on the right hand mid section of the firewall and bolt the tie down brackets into place with AN3-6A bolts as shown. Position the battery box 50mm up from the lower bend and fix in place with 4 x 5/32 pop rivets, with a washer on each side of each rivet.



Put the battery in the battery box with the terminals to the top and secure it with a tie down strap: loop the strap through the brackets and through the locking buckle with the free end of the strap pointing down at the front, then loop that free end back through the bottom bracket and tie it off around the strap and cut to length as shown. Use a flame to melt the cut end.

Cabin heater

Measure up 180mm from the lower bend and in 340mm from the left hand side of the firewall step and drill a pilot hole, then drill a 1 5/8" (41mm) hole for the cabin heater firewall fitting.



The fitting is in several parts: press the machined end of the short section of tube into the hole on the side of the main body. Assemble the shaft, flap and actuating arm and then push the threaded end of the main body through the firewall.



Turn the main body so that the pressed-in tube faces the left of the aircraft and fit a small screw into the notch in the flange to prevent the main body from turning (circled above).

Drill a 1/8" hole in the firewall above the main body and directly below the shaft: pop rivet the right-angled spring bracket into this hole and connect the spring to it. Drill a 5/16" hole for the cable directly in line with the end of the actuating arm. Fit the retaining nut to the threaded end of the main body on the inside of the firewall and tighten firmly.

Fuel fitting

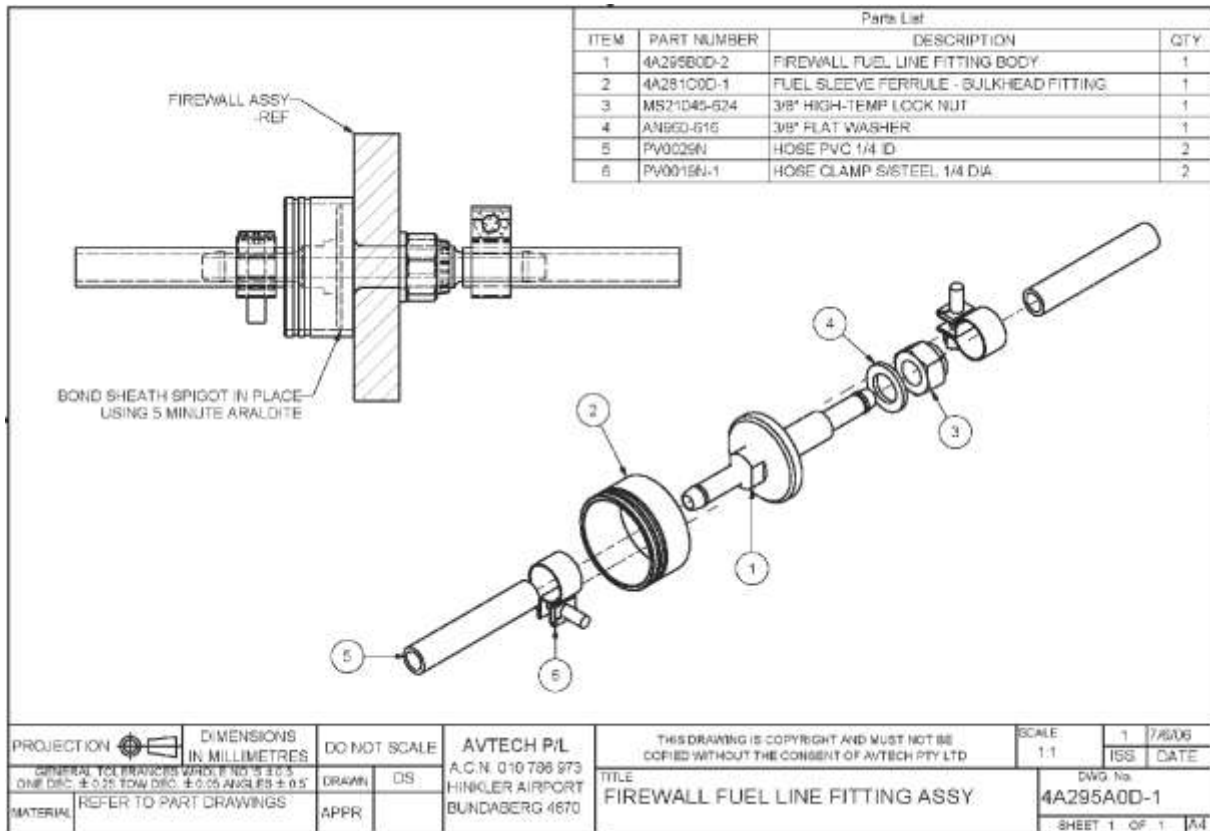

Assemble the firewall fuel line fitting: Press the flat plate of the brass bulkhead fuel fitting into the top of the aluminium sleeve (this sleeve connects to the plastic fuel sheath on the inside of the firewall), and bond it into place with 5-minute Araldite.

Drill through the pre-drilled hole in the firewall and fit the assembly, fit the washer and Nyloc nut and tighten.



Electrical components

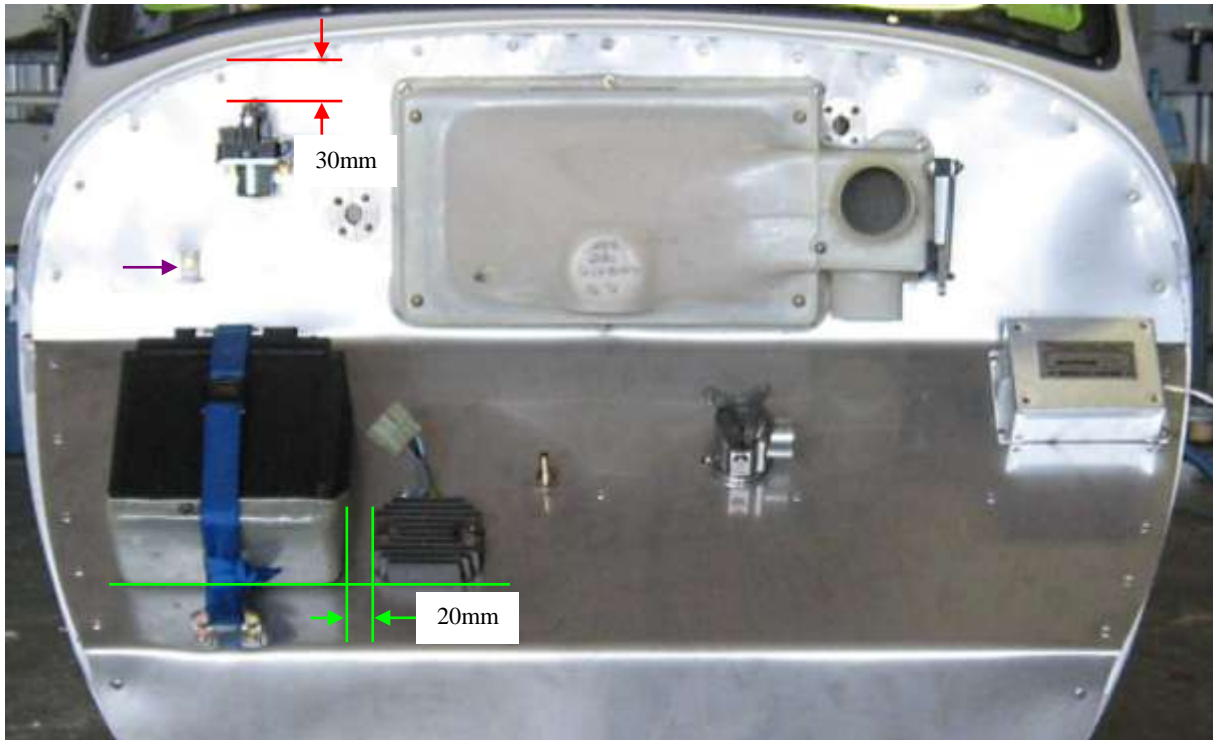

Use some 3mm aluminium to make backing plates for the solenoid and the earth terminal as shown below – these are to spread the load and minimise crushing of the plywood firewall.

Place the starter solenoid as shown with the top of the terminals 30mm below the top of the firewall. Fix the solenoid into place with 2 AN3-7A bolts, washers and Nyloc nuts.

Fit the main electrical earth terminal (maroon arrow above) by drilling through the pre-drilled hole in the firewall and fix into place with an AN3-7A bolt, washer and Nyloc nut.

Place the regulator module 20mm in from the side and in line with the bottom of the battery box (green lines above). Fix the module in place with AN3-12A bolts, washers and Nyloc nuts. The optional strobe unit is placed as shown and secured with 6G self-tapping screws.

Inside view

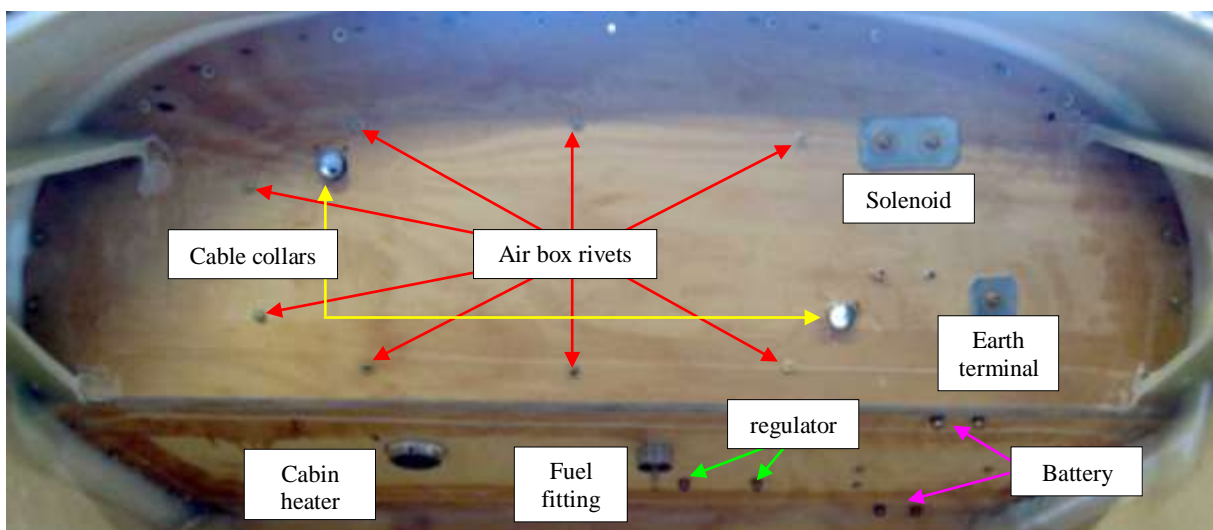

This is how the finished job will look from the inside.

Air box outlet tube

Remove the cover from the air box: it is held in place by 4 screws, one at each corner.



Cut a hole in the bottom of the angled lower front part of the cover and fit the supplied short length of fibreglass tube and fit in place so that when the cover is laying on the workbench as shown at above left the tube angles upwards at an angle of 15°.

Fix the tube in place with a mixture of 5 minute Araldite and flock, filling the area around the inside and outside of the join.

Use enough of the Araldite/flock mixture to completely fill the area surrounding the tube on the inside of the cover as shown above right. You may need a second mix to complete this.



When the Araldite/flock mix has cured, grind the protruding lip on the inside of the cover down until it forms a wide radius into the tube so that the air has a smooth flow from the air box and into the tube – any sharp edges at this transition can have the effect of restricting airflow to the carburettor so take your time and get the curve just right.

Fit the cover back onto the air box.

This completes the *Pre-Paint>Fuselage>Firewall forward>Firewall fittings* task.

Pre-Paint>Fuselage>Firewall forward>Assemble and fit nose gear

Objectives of this task:

To assemble and fit the nose gear including the front wheel to the stage where the aircraft is standing on its own 3 wheels, the main gear having been fitted previously.

Materials required:

Card # J7 'Undercarriage'

Card # J19 'Nose leg'

Card # J20 'Nose wheel'

Epoxy resin and flock

Steps

1. Assemble the nose leg
2. Assemble the nose leg housing
3. Fit the nose leg housing
4. Assemble the nose wheel
5. Fit the nose leg and nose wheel



Assemble the nose leg

Assemble the nose leg by reference to the drawing 2 pages over.

Press the nylon bush through the tube at the bottom of the leg (photo at right) and flock in place if needed, then fit the machined yoke with an AN4-72A bolt, washer and castellated nut. Use a split pin to retain the castellated nut. Fit the lower retaining collar to the machined section of the nose leg (arrowed above) with an AN3-22A bolt.



Fit the lower part of the suspension shaft to the yoke, placing the nylon bush through the bottom hole, superglue a washer on each side and secure in the yoke with an AN5-15A bolt, washer and Nyloc nut as shown circled in yellow in the photos below.

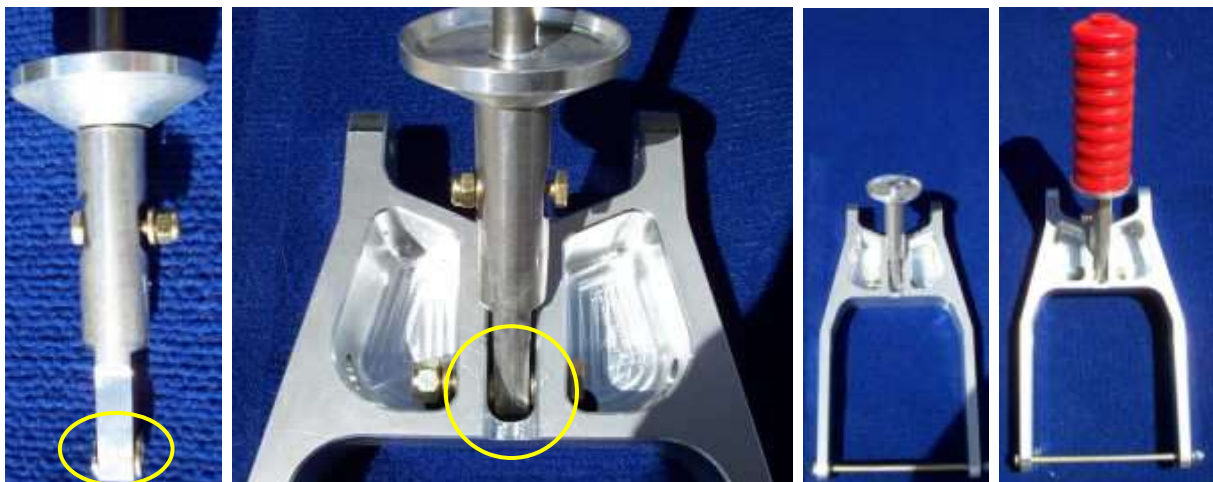

Slip the tapered lower washer onto the lower suspension shaft and place the red suspension rubbers over the upper shaft as shown above right. Note that in the photos above the nose leg has been left out for clarity.

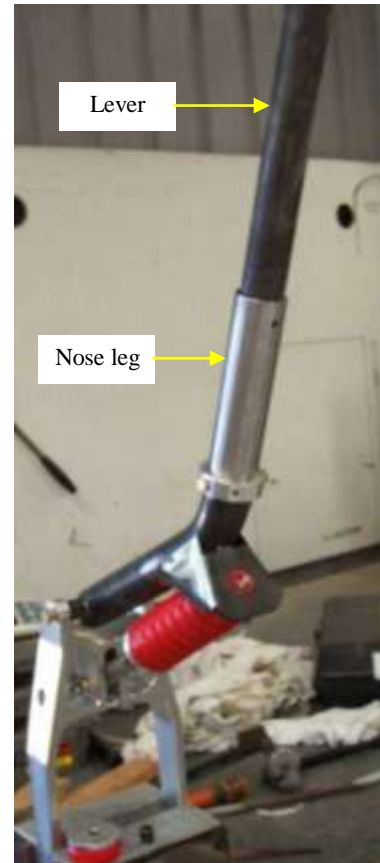
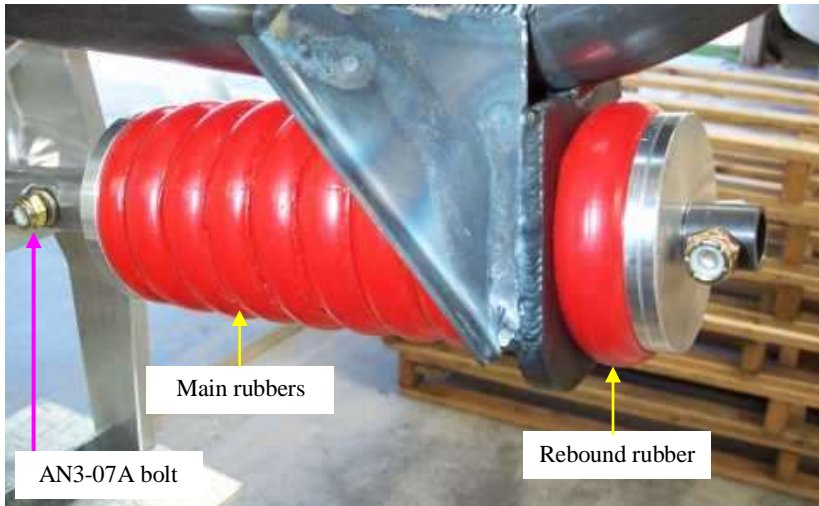

Fit the machined washer and rebound rubber to the top of the inner suspension shaft and secure to the shaft with the retaining collar and an AN3-06A bolt and Nyloc nut. Clamp the yoke in a vise and use a long bar inserted into the top of the nose leg as a lever to compress the rubbers until the inner shaft can be secured with an AN3-07A retaining bolt (arrowed above left).

Compressing the rubbers will require substantial pressure: the lower part of the leg will need to be almost horizontal in order to fit the retaining bolt. Take care that the yoke is firmly held by the vise and apply downward pressure on the lever smoothly.

Tighten the Nyloc nut firmly and then slowly release the pressure on the lever.

Assemble the nose leg housing

Assemble the top and bottom plates to the spacer with the supplied cap screws – clean the threads, use a drop of Loctite 620 on each cap screw and tighten firmly. Clean the nylon bushes and the matching holes in the top and bottom plates with Acetone and sand all surfaces to be bonded and then fit the bushes into the plates, pushing both bushes from the outside in towards the middle. Align the flats on the bush collars to clear the cap screws.



Fit the assembly onto the nose leg with a retaining collar or yoke bolted to the top and check for freedom of movement. When you are satisfied that there is no binding, mix a small batch of flock and flock the bushes into the plates, taking care not to get any flock onto the nose leg.

Use a mixing stick to smooth the flock as shown at above right and leave overnight to cure. Drawings of the nose leg and nose leg housing follow on the next 2 pages.



ITEM	PART NUMBER	DESCRIPTION	QTY
1	6A004A0D	H.D. NOSE LEG ASSY - MACHINED YOKE, BIG FOOT.	1
2	6C13023	NOSE WHEEL ASSY - CAST RIM, BIG FOOT.	1
3	6A002C0D	RUBBER ASSY NOSE LEG - MACHINED YOKE, BIG FOOT.	1
4	6A002B0D	NOSE LEG RUBBER SHAFT BASE (MACHINED YOKE)	1
5	6A002D0D	NOSE LEG RUBBER LOWER END WASHER (MACHINED YOKE)	1
6	80B5044	FRONT AXLE BIG FOOT	1
7	6064044	SPACER BUSH - FRONT AXLE BIG FOOT	2
8	PB5A000N	5/16 ID, 3/8 OD, 3/8 LONG SKF GLYCODUR F BUSH	1
9	AN5-15A	5/16 BOLT	1
10	ANB60-516	WASHER	4
11	M520365-524	5/16" NYLOC NUT	1
12	6061044	RETAINING COLLAR - NOSE LEG RUBBER	1
13	AN3-06A	3/16" BOLT	1
14	M520365-1032	NUT	4
15	AN4-63A	BOLT - WHEN USED WITHOUT SPATS. USE BOLT P/N: AN4-72 WHEN SPATS ARE INSTALLED	1
16	ANB60-416	1/4" FLAT WASHER	1
17	M520365-428	1/4" NYLOC NUT	1
18	ANB-43	5/16 BOLT	1
19	AN310-5	5/16" CASTLE NUT	1
20	M524685-132	COTTER PIN	1
21	6A001A0D-8	MACHINED NOSE WHEEL YOKE - BIG FOOT	1
22	AN3-07A	3/16" BOLT	1
23	ANB60-10	3/16" FLAT WASHER	1
24	6A002F0D	NOSE LEG RUBBER SHAFT TOP (MACHINED YOKE)	2
25	604709N	BUSH SUSPENSION - BIG FOOT PIVOT	1
26	6A002C3D	REBOUND RUBBER - MACHINED YOKE NOSE LEG.	1
27	6200014	STEERING LINK MACHINED LEG 4 SEATER	1
28	6191004	RETAINING COLLAR FRONT SUSPENSION	1
29	AN3-22A	3/16" BOLT	2
30	ANB60-10L	3/16" FLAT WASHER (1/2 THICKNESS)	2

PROJECTION	DIMENSIONS IN MILLIMETRES	DO NOT SCALE	AVTECH P/L	SCALE	ISS. DATE
LIMITS UNLESS SPECIFIED OTHERWISE ± .4:1	REFER TO PART DRAWINGS	DRAWN DS	A.C.N. 010 786 973	VAR	1 8/5/03
MATERIAL		APPR.	HINKLER AIRPORT	DRAWN BY	
			BUNDBERG 4870	6A002A0D-5	
				SHEET 1 OF 3 A3	



Parts List		ITEM	PART NUMBER	DESCRIPTION	QTY
		1	6194104	MACHINED NOSE LEG BUSH	2
		2	PH0535N	1/4" x 0.75" UNC CAP SCREW	4
		3	AN980-416	1/4" FLAT WASHER	8
		4	MS20386-428	1/4" NYLOC NUT	4
		5	6A003B00	END PLATE - MACHINED NOSE LEG HOUSING	2
		6	AN4-76A	BOLT	2
		7	AN4-24A	BOLT	2
		8	6A003F00	MACHINED NOSE LEG HOUSING OUTER WASHER	1
		9	6A003E0N	MACHINED NOSE LEG HOUSING INNER BACKING PLATE R/S	1
		10	6A003C0D	INTERNAL BRACING L.S. - MACHINED NOSE LEG HOUSING	1
		12	6A003D0D	VERTICAL PLATE - MACHINED NOSE LEG HOUSING WITH CENTREING	1

NOTE: FOR USE IN J160 FAMILY FUSELAGES, UPPER SECTION OF REO MUST BE CUT OFF. USE LOWER BOLT HOLE WHEN MOUNTING TO FIREWALL

APPLY LOCTITE 620 TO THREADS ON ASSEMBLY

CLEAN BONDING SURFACE BY WIPING IT WITH A CLEAN RAG MOISTENED WITH ACETONE. THEN ABRASE SURFACE WITH EMERY PAPER & BRUSH OFF EXCESS DUST WITH A CLEAN RAG. BOND BUSHES TO END PLATES USING COTTON FLOCK & LC3600 EPOXY RESIN.

SCALE: 1:270A03

VAR: 1

ISS: DATE

DWG. NO: 6A003A0D-5

SHEET 1 OF 1 A3

PROJECTION	DIMENSIONS IN MILLIMETRES	DO NOT SCALE	AVTECH P/L	SCALE	VAR	ISS	DATE
LIMITS UNLESS SPECIFIED OTHERWISE ± M-1	REFER TO PART DRAWINGS	DRAWN	A.C.N. 010 786 973				
MATERIAL		APPR.	HINKLER AIRPORT	THIS DRAWING IS COPYRIGHT AND MUST NOT BE COPIED WITHOUT THE CONSENT OF AVTECH P/L LTD			
			BUNDBERG 4670	TITLE			
				MACHINED NOSE LEG HOUSING			

Fit the nose leg housing

Level the aircraft laterally: a straightedge across the bottom of the front doorframes or across the front wing attachment lugs will provide a good reference, then pack under the main wheels as required in order to level the aircraft in the lateral or rolling plane.



Place a straightedge or ruler under the centre of the fuselage and measure up 5mm. This is the position for the bottom of the square outer backing plate for the nose gear housing.

Centre the outer backing plate on the lower firewall and drill one top 1/4" hole only and push a bolt through, then fit up the nose gear housing and place a digital protractor or a spirit level across the top of the white bush as shown above and carefully level the nose gear housing.

Once it is level, drill the other top hole and recheck for level then drill the bottom holes and bolt the nose gear housing in place. You will need to flock the 2 internal braces in place at this time – trim to length then sand and clean the surfaces to be bonded. Mix a small batch of flock and coat the back of each brace then press into place and secure with 2 x AN4-16A bolts at the top and 2 x AN4-22A bolts at the bottom and tighten the Nyloc nuts firmly.

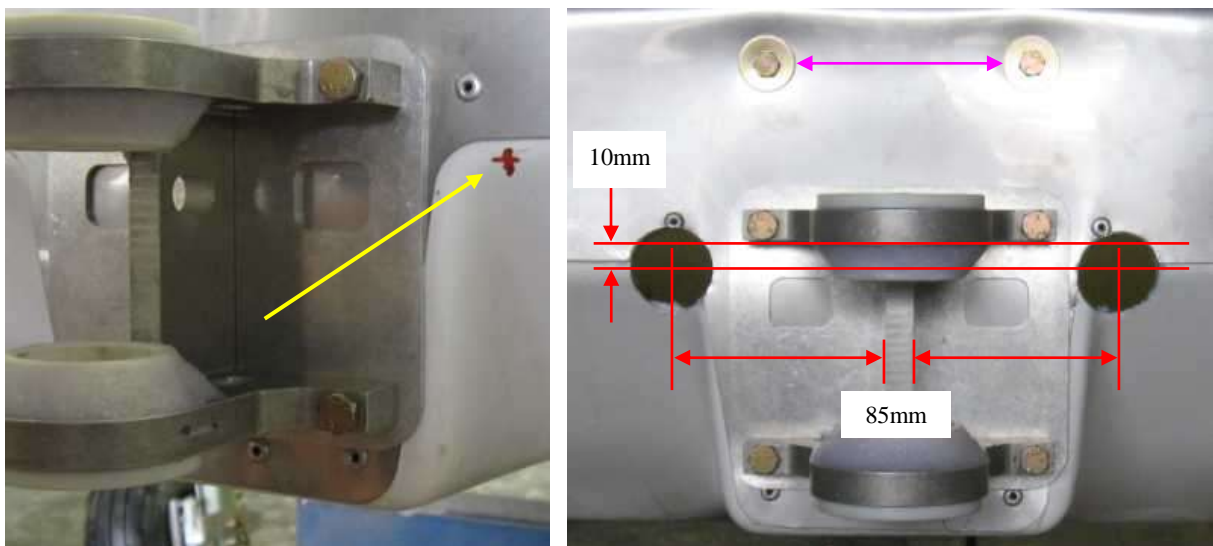

Drill the holes for the steering links: measure out 85mm from each side of the centre plate and down 10mm from the bottom side of the top plate and mark and drill a pilot hole, then use a 1 1/4" hole saw to drill through the firewall.

Drill the top holes of the internal braces (arrowed in purple above right) from the back of the firewall and then fit the bolts from the firewall side with 1 penny washer under the head of each bolt and a normal washer and Nyloc nut on the inside of the firewall.

Assemble the nose wheel

Press a bearing into each side of the hub until the bearing reaches the bottom of the machined hole – use a large socket or piece of heavy tube that is slightly smaller in diameter than the outside of the bearing to press against the outer rim of the bearing. A small hand press or a bench vise would be ideal for the purpose. Do **not** press against the inner rim of the bearing – this can damage the bearing.



Fit the bearing spacers into the bearings with a drop of Loctite 480 and slide the axle through the spacers.

Check each end of the axle and spacer: both ends should be exactly level. If this is not the case then grind either the axle or the spacer until they are level. If the width of the wheel and spacers are wider than the length of the axle this will put a side load of the wheel bearings.

Partially inflate the inner tube with the valve out, then liberally coat the tube with talcum powder, fit it into the tyre and place the tyre on the hub with the valve stem facing up and then fit the rim to the hub, making sure that the valve stem is through the hole in the rim, bolt the rim to the hub, taking care not to pinch the inner tube, and inflate the tyre to 35 PSI.

A drawing of the nose wheel can be found on the next page.

Fit the nose leg and nose wheel

Slide the nose leg up into the nose leg housing with the steering yoke (arrowed but not shown in photo) fitted over the nose leg between the top and bottom bushes and with the arms of the yoke swept back towards the firewall and fit the nose leg in place with the retaining collar above the top bush. Secure the collar to the nose leg with an AN3-22A bolt and Nyloc nut.

Roll the front wheel into the machined yoke and fit with the AN4-72 bolt. Use a washer and castellated nut, tighten the castellated nut and secure it with a split pin.

The aircraft is now sitting on its own wheels, however it will still need a trestle under the empennage until the engine has been fitted in the next task.



Parts List			
ITEM	PART NUMBER	DESCRIPTION	QTY
1	6213123	CAST INNER WHEEL RIM (8")	1
2	6211023	CAST OUTER WHEEL RIM (8")	1
3	P80028N	BEARING	2
4	500x6	TYRE 500 X 6	1
5	MS20395-428	NUT	4
6	AN860-418	1/4" FLAT WASHER	8
7	AN4-11A	BOLT	4

PROJECTION	DIMENSIONS IN MILLIMETRES	DO NOT SCALE	AVTECH P/L	SCALE	ISS. DATE
REFERS TO PART DRAWINGS	IN MILLIMETRES	DRAWN DS	A.C.N. 010 786 873	VAR	DATE
	REFER TO PART DRAWINGS	APPR.	HINKLER AIRPORT		
			BLINDBERG-4670		
			TITLE	DWG. NO.	
			NOSE WHEEL ASSY - CAST BIGFOOT RIM	6213023-1	
					SHEET 1 OF 1
					1A3

This completes the *Pre-Paint > Fuselage > Firewall forward > Assemble and fit nose gear* task.

Pre-Paint>Fuselage>Firewall forward>Fit engine mount and engine

Objectives of this task:

In this task the engine mount will be fitted to the firewall at the top attach points only, the engine will be attached to the engine mount, then the engine angle of incidence will be set and finally the engine mount will be fitted to the bottom attach points on the firewall.

The engine angle of incidence is particularly important, both to the general flying qualities of the aircraft as well as making the fitting of the cowls more straightforward, and should be set carefully and precisely. You will need either a portable engine lifter or a few strong friends to help you mount and position the engine in this task.

From this point on the engine will remain fitted to the fuselage.

Parts required:

Engine mount sets: AN4-20A & -31A bolts plus washers, spacers, rubber mounts ►

From Card # J10 'Firewall', the 4 x 4025094 backing plates (photo below right)

From Card # J23 'Engine', the washers and lock nuts in "Engine mount hardware"



Fit the engine mount to the firewall

Now would be a very good time to paint the engine mount! We prefer gloss black.

Drill the top engine mounting holes through the stainless steel firewall plate from the inside, through the pre-drilled holes in the plywood firewall that you cleaned in the previous task.



Attach the engine mount to the firewall with the top (AN4-20A) bolts only: fit each bolt from the front, through the mount, firewall, and the backing plate (shown at right) and fit a washer and Nyloc nut.

Tighten the Nyloc nut firmly but without crushing the plywood firewall. Do not bolt the bottom of the engine mount to the firewall at this stage; leave it until the engine angle of incidence has been set. Note that the bottom centre section of the engine mount rests against the penny washers of the top internal brace bolts but does **not** rest on the heads of the bolts.



Fit the engine to the engine mount

Fit the female rubbers to the top mounts and the machined spacers and male rubbers to the bottom mounts – refer to the drawing on the next page for details.

With the rear of the aircraft supported and with the main wheels chocked, lift the engine into position and fit the rear engine mount plate onto the bottom engine mounts first: you may need to tilt the engine slightly down at the front to do this. Use AN4-31A bolts fed from the rear of the mounts with the lock nuts towards the front.

Lift the front of the engine and fit the top rear engine mount plate onto the top mounts and fit the male rubbers, machined washers, flat washers and lock nuts to both top mounts. Fit the female rubbers, flat washers and lock nuts to both bottom mounts. Note that these are *steel* lock nuts and not Nylocs.

It may be necessary to compress the mount rubbers in order to get the steel lock nuts on: use a “G” clamp or similar and clamp across a socket on the head of the bolt and the side of the machined washer beside the steel lock nut, as shown at right. The clamping points have been circled in yellow.



Torque each of the 4 steel lock nuts to 11 Nm (8 foot pounds).

Level the aircraft

For the next step the aircraft must be absolutely level in both the lateral (rolling) and longitudinal (pitching) planes.



Lateral plane: place a 3” block on the top of each front wing mounting lug and place a spirit level or a digital protractor across the top of the cabin so that it rests on both blocks. Pack the main wheels as required to level the aircraft.

Longitudinal plane: the objective is to level the fuselage along the “waterline” – the line of the join between the upper and lower sections of the fuselage. Use a spirit level or a digital protractor and pack under the nose wheel or empennage until the waterline is level.

Once the aircraft is satisfactorily levelled make sure it stays that way: chock the wheels and consider lashing the empennage to the packing with a tie-down strap.

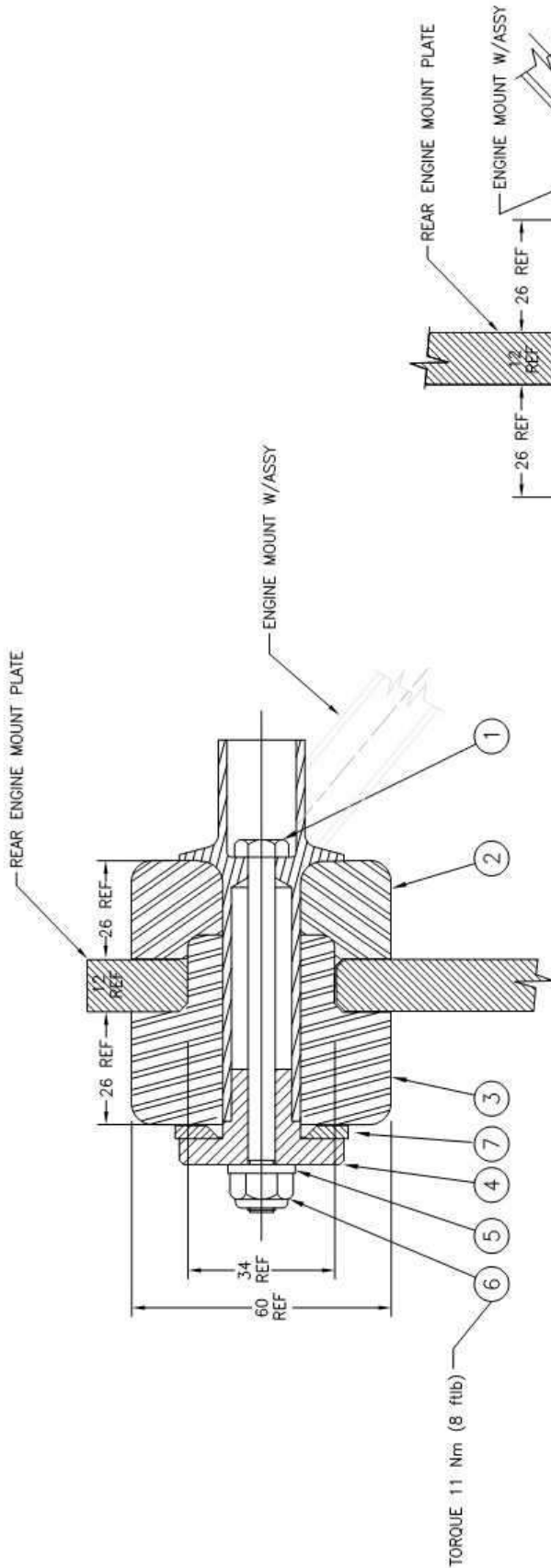

UPPER ENGINE MOUNT CONFIGURATION

APPLICABLE JABIRU 2200, AND 3300 ENGINE INSTALLATIONS IN JABIRU AIRCRAFT

TORQUE 11 Nm (8 ftlb)



LOWER ENGINE MOUNT CONFIGURATION

APPLICABLE JABIRU 2200, AND 3300 ENGINE INSTALLATIONS IN JABIRU AIRCRAFT

ITEM	PART No.	DESCRIPTION	QTY.
7	4214934	WASHER- ENG MNT SPACER	1
6	MS21042-4	NUT	1
5	AN960-416	WASHER	1
4	4094224	WASHER ENGINE MOUNT	1
3	PG10722N	CUSHION MOUNT MALE	1
2	PG10712N	CUSHION MOUNT FEMALE	1
1	AN4-31A	BOLT	1

2	010528
1	001109
ISS.	DATE
DWG. NO.	9606004
SHEET 1 OF 1 A3	

SCALE	1:1
TITLE	VIBRATION MOUNT INSTALLATION
AVTECH P/L	HINKLER AIRPORT BUNDEBERG
A.C.N. 010 786 973	
APK	
APPR.	
PURCHASED PARTS TO PS22J-10	
LIMITS	
MATERIAL	

Set the engine angle of incidence

In this step the engine will be adjusted until a level or digital protractor (pictured below) placed on the top of the crankcase reads completely level fore and aft, which indicates an angle of incidence of 0° (zero degrees).

In our factory we usually find that the angle of incidence is correct with the standard mount, however the following procedure should still be followed.



Recheck that the aircraft is completely level and then measure the angle of incidence and use a hydraulic jack under the crankcase to lift the front of the engine to a point where the engine has a very slight (0.5° if using a digital protractor) nose-up attitude then drill the bottom engine mount holes through the firewall and fit the AN4-20A bolts, backing plates, washers and Nyloc nuts. Now release the jack and recheck the angle of incidence. If the engine is slightly down at the front you can fit up to a maximum of 3 penny washers under each bottom engine mount to adjust the angle of incidence. Bear in mind that a small adjustment at the firewall will result in a large change at the propeller flange.

Check the lateral angle of the engine while the aircraft is completely level: it should be very close to level.

Once you're happy with the alignment you can permanently install the lower engine mount bolts, taking care to remember the backing plate (pictured on the first page of this task), and tightening the Nyloc nuts enough to hold firmly but without crushing the plywood firewall.

If penny washer spacers were used on the lower engine mounts then equivalent thickness spacers will need to be used behind the bottom bar on the mount. Drill these mounting holes at 3/16", fit the appropriate spacers if required, and finally fit 2 x AN3 bolts through the bottom bar and the firewall and fit washers and Nyloc nuts.

This completes the *Pre-Paint>Fuselage>Firewall forward>Fit engine mount and engine* task.

Pre-Paint>Fuselage>Firewall forward>Fit propeller flange extension**Objectives of this task:**

To remove the universal propeller flange that is shipped with the engine and fit the model-specific propeller flange extension to the crankshaft. While this is a straightforward mechanical task it is most definitely a **critical** task and care must be taken.

The universal propeller flange is lock wired in place, however the depth of the propeller flange extension makes the use of lock wire almost impossible and so we use a strong Loctite to keep the flange securely fitted. This means that the cleanliness of all threads is critical.

This task will require 2 people: 1 to stop the crankshaft from moving and 1 to loosen and later tighten the cap screws. This task is intended to be performed by the kit builder with the engine mounted to the aircraft. In the factory we do this task while the engine is fitted to a mobile engine stand so some of the photos will be slightly different to what the kit builder could expect to see.

Materials and equipment required:

Loctite 620 and lockwire

Thread cleaner – Loctite 7471 or Acetone

5/16" Hex drive socket, or alternately a 5/16" Allen key cut straight and fitted to a 5/16" socket

Torque wrench, set to 30 ft/lbs or 40 Nm

Remove the universal flange

The universal flange is held in place by 6 x 3/8" UNF Allen head cap screws, all of which will be reused.

Cut and remove the lock wire from the 6 cap screws, then heat the cap screws with a heat gun in order to loosen the Loctite.

Lock the engine from turning by holding a large blade screwdriver in the ring gear teeth between the starter motor and the adjacent alloy block (circled in the photo above right).

Crack each cap screw in turn to break the Loctite seal and remove each cap screw and the related washer.

Set the cap screws and washers aside for later use.

Remove the flange and discard.

Clean and prepare the screws and hub



Clean the cap screw threads with a wire brush – make sure that there is no residual Loctite in the threads. Clean all threads with cleaning solvent (Loctite 7471 cleaner or Acetone) and dry.

Run a 3/8" UNF flat bottomed tap all the way into each bolt hole in the hub, apply a cleaning solvent (Loctite cleaner or Acetone) into each hole and then blow dry with compressed air.

Check that each thread is absolutely clean and dry before proceeding.

Fit the propeller flange extension

Set your torque wrench to 30 ft/lbs or 40 Nm and place it on top of the engine.



Apply a few drops of Loctite 620 to each screw hole, place the propeller flange extension on the hub and fit the 6 cap screws and washers.

Have your helper lock the engine from turning and tighten all the cap screws firmly then torque each cap screw to 30 ft/lbs or 40 Nm, working in a criss-cross pattern as shown at right. Re-check each cap screw, applying steady pressure on the torque wrench until the torque value is reached.

Re-check the torque values again and then lockwire each pair of cap screws together. Lockwiring cap screws in extended propeller flanges is very difficult. Jabiru only lockwire cap screws in standard propeller flanges.

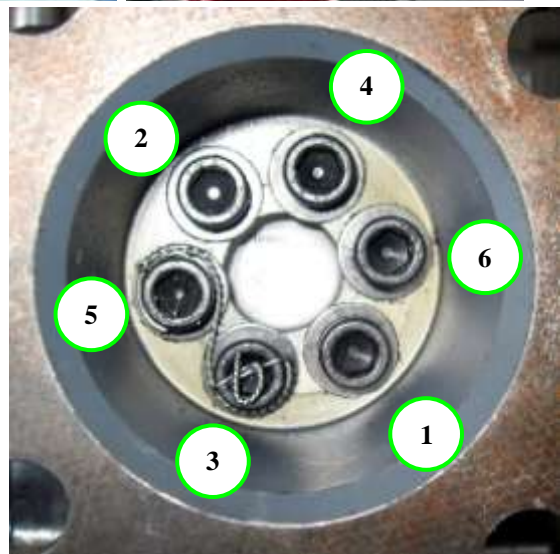

This completes the *Pre-Paint>Fuselage >Firewall forward>Fit propeller flange extension* task.

Pre-Paint>Fuselage>Firewall forward>Fit oil cooler

Objectives of this task:

In this task the oil cooler will be fitted to the base of the sump, the oil filter adapter will be fitted under the oil filter and the whole assembly plumbed up and the oil overflow bottle will be fitted to the firewall. There are 2 types of oil overflow bottles, fibreglass moulding or a plastic moulding.

Fireproof sleeving will be used to protect the oil lines.

Materials required:

Card # J24 'Oil Cooler Kit'

Pipe sealing compound (rated working pressure of 2.6 Mpa, "Holdtite" brand or similar)

Mount the oil cooler

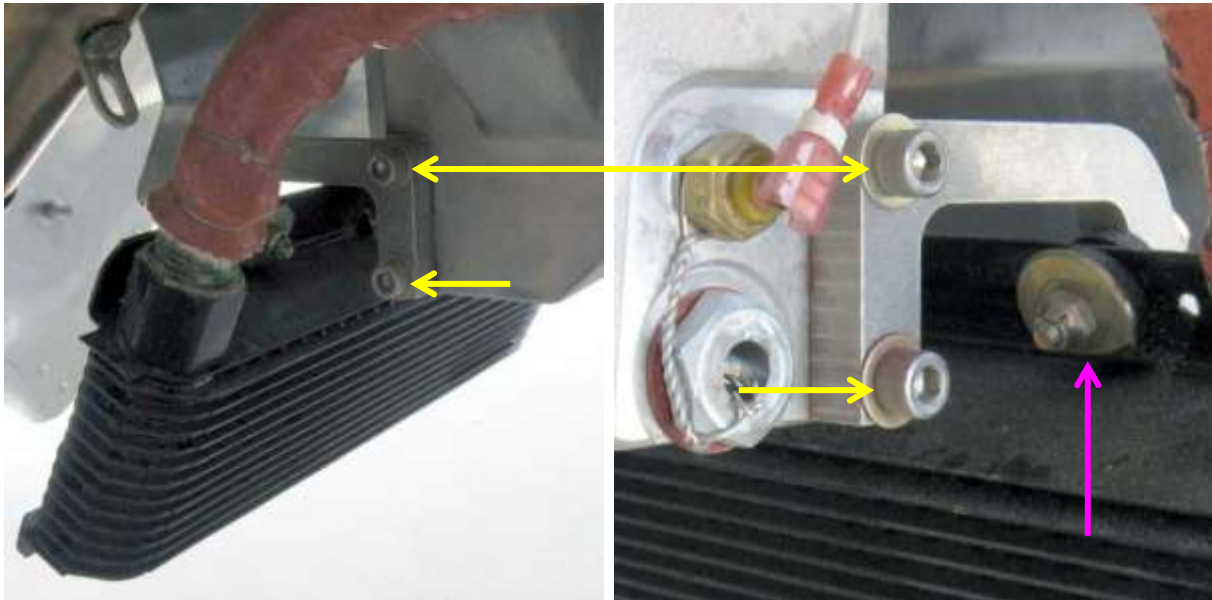

Mount the rails to the sump: fit the 3/16" **cap screws** through a flat washer and the rail and into the threaded holes in the sump and tighten. Drill each of the 4 large holes in the cooler out to 9/16" and fit a rubber grommet, then fit a Bundy tube in the bolt hole and mount the cooler to the rails using AN3 bolts fitted from the rear and steel lock nuts with a penny washer under each lock nut as shown above. Note that the penny washer will need one side **cut away**.



Refer to the drawing on the next page for detail.

THIS DRAWING IS COPYRIGHT AND MUST NOT BE COPIED WITHOUT CONSENT OF AVTECH PTY LTD

DIMENSIONS IN MILLIMETRES

DO NOT SCALE

PROJECTION

#	PART No.	DESCRIPTION	QTY
1	1A041A00	280 LINES COIL	1
2	4A263A00-1	OIL COOLER ASST	1
3	44163A00	OIL COOLER MOUNT	2
4	W000000	JABIRU 2000 ENGINE ASST	1
5	PH00000	OIL HOSE	T.S.
6	PH00000	HOSE METAL	2
7	4000004	THREADED ADAPTOR 3/4 UNF 1	1
8	PH00000	25220 O-RING	1
9	4120004	FITTING OIL FILTER	1
10	4001004	OIL COOLER ADAPTOR	1
11	2200	FITTED 2000 OIL FILTER	1
12	PH00000	FINE SLEEVE #	T.S.
13	PH00000	HOSE CLAMP	4
14	PH00000	LOCK WIRE	T.S.
15	PH00000	3/8"x1/2" NPT HOSE FITTING	2
16	AN3-17A	3/8" BOLT	4
17	M020A04-L3	3/8" FINE PNEUM NUT	8
18	AN170-10	PENNY WASHER	4
19	PH00000	OIL COOLER MOUNT RUBBER	4
20		1/4" X 1/4" BUNNY SPACER	4
21	M020A04-L2	3/8" METAL TREAD SCREW	4

REFER TO DETAIL A
GENERAL VIEW
SCREWS INTO U.S. CRANKCASE

DETAIL VIEW B - OIL COOLER ADAPTOR INSTALLATION
1/4" BUNNY TUBE SPACER 12mm LONG.

DETAIL VIEW C - OIL COOLER MOUNTING DETAILS

DETAIL VIEW A - OIL COOLER INSTALLATION
AIR IN -REF
AIR OUT AND COIL -REF
AIR FLOWING THRU COOLER -REF
PLACE A 1/4" OIL COOLER BUNNY TUBE TO FIT FRONT OF OIL COOLER
REMOVE GAPS BETWEEN OIL COOLER AND DUCT FOR COOLING EFFICIENCY

DETAIL VIEW D - OIL COOLER MOUNT TO SUMP INSTALLATION
DETAIL C FOR RUBBER MOUNT INSTALLATION

JW	2	150506
SCALE	1	13/9/05
VAR		ISS. DATE

DWG. NO.	
4A263A00-2	
SHEET 1 OF 1	

AVTECH P/L	DM	DRAWN	APPL
HINKLER AIRPORT BUNDABERG			

TITLE	
J160 OIL COOLER INSTALLATION (2.2L)	

Fit the oil lines

Fit the 2 brass male barb fittings to the inlet and outlet of the cooler - apply a smear of pipe sealing compound to the threads and tighten each fitting firmly into the cooler. Take care **not** to over tighten these fittings, as the brass threads will strip if excess pressure is applied.

Remove the spin-on oil filter and fit the adaptor (circled at right) under it with the O-ring side towards the engine block. Apply a smear of clean engine oil to the O-rings on the adaptor and the oil filter, refit the oil filter and tighten gently until resistance is felt as the seal first contacts the housing and then tighten exactly one full turn from that point.



Absolute cleanliness is required here: there must be no dirt or contaminants anywhere near the oil filter or adaptor fitting area.

Size the blue oil lines by holding one end beside the fitting on the right-hand side of the oil cooler and cutting to length to fit the rear adaptor fitting. Allow for a smooth routing.

Repeat the process for the other side of the oil cooler to the front adaptor fitting and then cut 2 lengths of fireproof sleeve to the same length as the oil lines and fit them over the oil lines.

The fireproof sleeve can be difficult to fit, but blowing compressed air into the gap between the oil line and the sleeve while pulling the sleeve over the oil line works rather well.



Roll the last inch or so of the fireproof sleeve back on each end as shown above left and fit each oil line into place, securing each end with the supplied hose clamp and cutting off the excess length of the hose clamp screw.

Now roll the fireproof sleeve over the hose clamp and lock wire into place as shown in the photo above right, using a double loop and twisting off.

This provides fireproofing to the full length of each oil line.

The completed oil line arrangement is shown on the next page.



Completed oil line arrangement between the adaptor and the oil cooler

Oil overflow bottle

Fibreglass moulded oil bottle mounting.

The oil overflow bottle, as shown in the photo on the right, fits into a fibreglass bracket that is mounted on the lower right side of the firewall.

Position the oil bottle with the bracket fitted so that the inlet line from the engine oil filler will curve smoothly down to the top fitting in the oil bottle without rubbing against the inside of the cowl, and so that the outlet from the oil bottle can be routed over the lower engine mount as shown in the photo at right.

Mark the position of the bracket, then remove the oil bottle from the bracket and drill 2 x 5/32" holes in the flat back part of the bracket.

Place the bracket on the marks and drill through the firewall and fit the bracket with 2 x 5/32" rivets with plain washers behind.

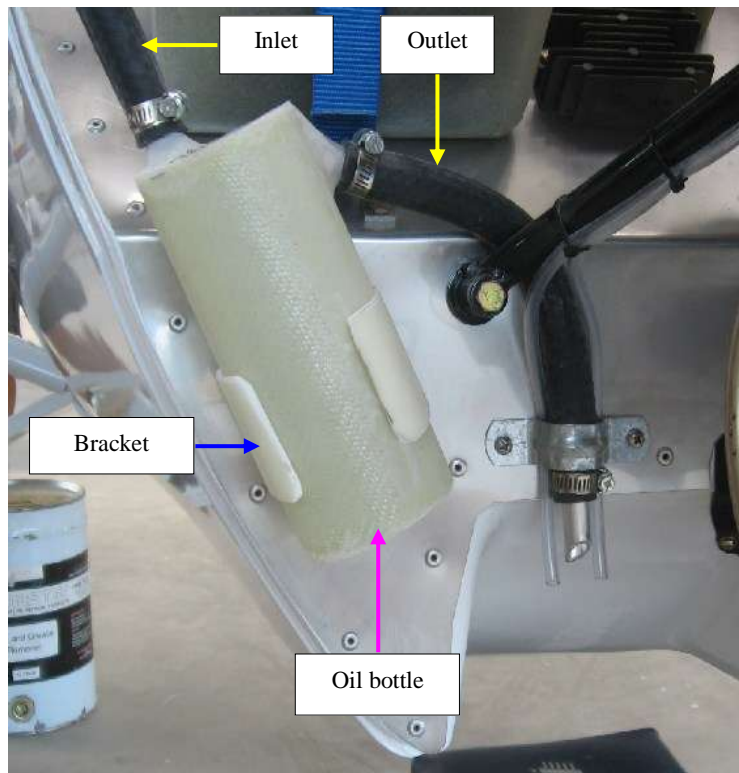

Fibreglass Oil overflow bottle shown final fitted

Remove the oil bottle and set aside for later fitting in the *Post-Paint>Fuselage>Firewall forward>Final assembly* task.

Plastic moulded oil bottle mounting.

The oil overflow bottle, plastic moulded type, as shown in the photo on the right, is mounted to the firewall with a saddle clamp on the lower outlet, on the lower right side of the firewall. The outlet is identified by an aluminium tube inserted in the connection stub, and is the larger diameter of the 2 connecting stubs.

Position the oil bottle so that the inlet line from the engine oil filler will curve smoothly down to the top fitting in the oil bottle without rubbing against the inside of the cowl, and so that the outlet at the bottom can be routed into the cutaway in the firewall as shown in the photo at right.

Place the saddle over the lower oil bottle outlet and mark the position to drill through the firewall to fit the saddle clamp with 2 self tapping screws 6G x 1/2" long.

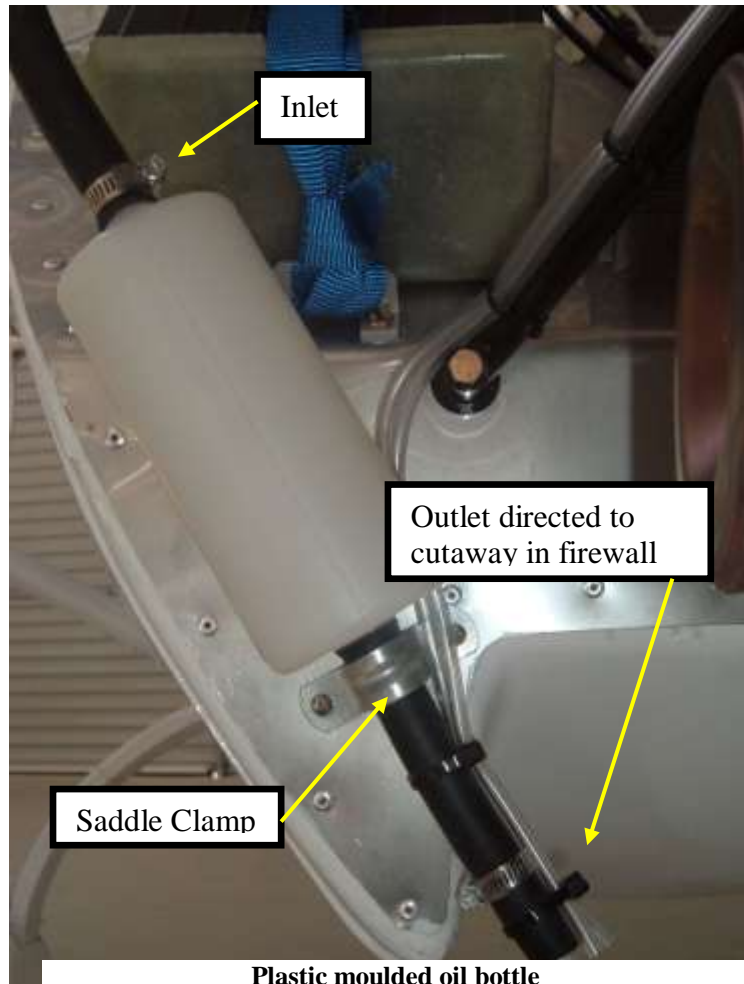

Remove the oil bottle and set aside for later fitting in the *Post-Paint>Fuselage>Firewall forward>Final assembly* task.

This completes the *Pre-Paint>Fuselage>Firewall forward>Fit oil cooler* task.

Pre-Paint>Fuselage>Firewall forward>Fuel pump fittings

Objectives of this task:

In this task the drip tray will be prepared and fitted to the fuel pump and then the fuel lines will be fitted from the firewall fitting to the fuel pump and then to the carburettor.

Materials required:

5-minute Araldite and flock

Loctite 518 gasket sealant, lock wire

Card #11 'Fuel components', Card #15 'Spares'

Fit the fuel pump drip tray

Remove the drip tray (shown circled in the photo at bottom right) from the *Spares* card and prepare it: drill a hole in right rear corner, which will be the lowest point when the tray is fitted, and flock the drain fitting into place with 5-minute Araldite and flock.

Put a piece of tape over the inside of the tray and over the fitting and leave to cure.



Remove the fuel pump from the engine



Clean the gasket and the spacer block

Fit the fuel drip tray to the engine-driven fuel pump: remove the fuel pump carefully and along with the fibre spacer block, leaving the gasket on the engine block.

Clean the threads of the cap screws thoroughly and apply a drop of Loctite 262 to each screw.

Smear some gasket cement on both sides of the spacer block and then refit the whole assembly: hold it together with the Allen head cap screws through a flat washer, the drip tray, the pump flange, the spacer block and the gasket and screw into the engine block and tighten the cap screws firmly.



Re-fit the fuel pump with the drip tray underneath

Fit the fuel lines and drain hoses

The fuel lines are connected in 2 runs: from the firewall fitting to the engine-driven fuel pump; and from the engine-driven fuel pump to the carburettor fuel inlet fitting. If you are fitting a fuel flow or fuel pressure sensor it should be inserted into the fuel line between the fuel pump and the carburettor at a point near the midpoint of the line.

Cut some black fuel line to length for each run, allowing enough length for the fuel line to be routed smoothly between each pair of fittings. Cut some fireproof sleeving to the same length as each fuel line. Slip the fireproof sleeving over the fuel lines and roll the ends back so that you can fit the hose clamp over each end of the fuel line. Make sure that each fuel line is clear by blowing through it to remove any dust or debris before fitting.

Note that the fuel pump inlet is on the side of the pump and the outlet is on the top of the pump as pictured at right.

Use the flow arrows in the 2 photos on this page to help you visualise the fuel flow to and from the fuel pump.

Fit the top fuel line into place: this line runs from the top fitting on the fuel pump to the fuel inlet fitting on the carburettor.

Fit the lower fuel line into place: this line runs from the fuel fitting on the firewall to the side fitting on the fuel pump.

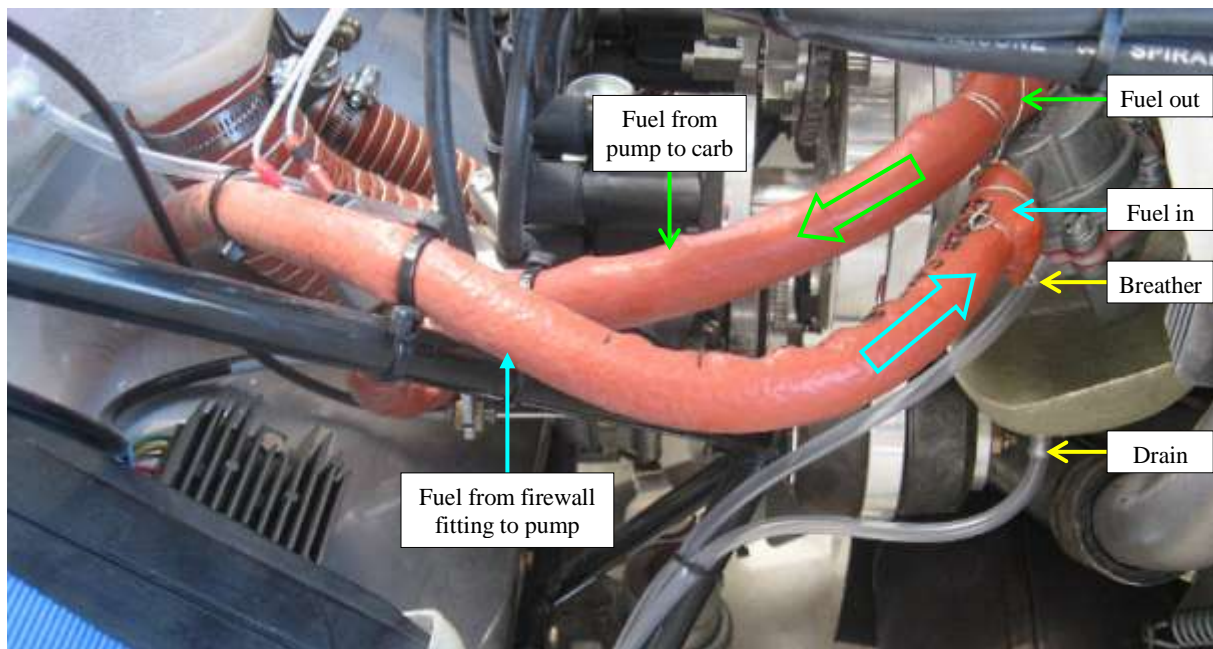
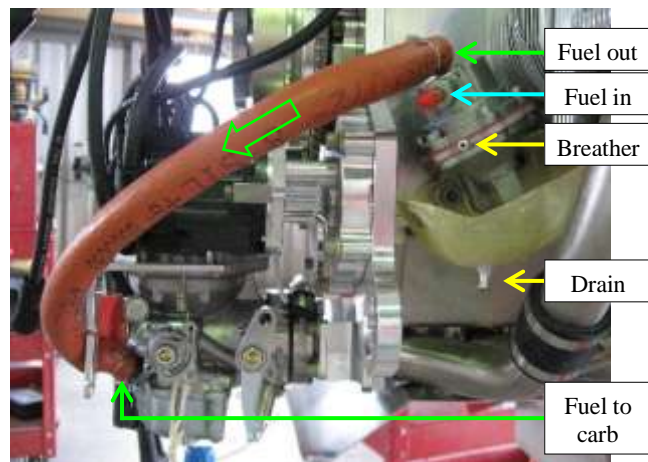

Roll the fireproof sleeving over the hose clamps and lock-wire the sleeve into place using a double loop of lock wire around both sides of the hose clamp.

Fit the fuel breather and fuel pump drain (clear) hoses, route back to the firewall and zip tie to the lower right engine mount tube and leave enough length for the hoses can be routed back to the firewall and end 50mm below the bottom of the firewall step.

This completes the *Pre-Paint > Fuselage > Firewall forward > Connect fuel pump* task.

Pre-Paint>Fuselage>Firewall forward>Fit ram air cooling ducts

Objectives of this task:

In this task the ram air cooling ducts will be assembled and fitted to the engine.

The final step, where the front of the ducts are trimmed to length to match the bottom cowling, cannot be performed until the bottom cowling has been fitted to the fuselage and so that step is included as part of the *Fit cowling* task that follows this task.

Air enters the front of the ducts and is routed up by low air dams, through the fins on the cylinder heads and barrels and then downwards at the rear by a pre-fitted angled baffle.

An aluminium tube directs cooling air from each duct to the nearest magneto coil.

Materials required:

Epoxy resin and AF303 glass fibre cloth (from the bag labelled “*Extra Cloth*”)

5-minute Araldite and flock

Assemble the ducts

Use a length of masking tape on the join line at the bottom of each duct inlet to hold the join firm and prevent Araldite/flock from leaking through.

Mix a small batch of 5-minute Araldite and flock and apply to the top of each join as shown at right:



Next the front air dams will need to be cut to size. Take the length of glass fibre sheet with the curved edge, hold it against the rear of the duct inlet with the curve towards the top rear of the duct and mark around the bottom of the duct then cut to shape as shown above.

Tape the air dam into place. Mix a small batch of 5-minute Araldite and flock and use it to fix the air dam into place. Leave to cure, then sand away any rough edges.

Remove the masking tape and roughen the underside of the duct and the back of the air dam.

Mix a small batch of resin and brush 2 layers of AF303 glass fibre cloth to the underside of each duct, covering the join line and wrapping up around the back edge of the air dam.

Leave overnight to cure.

Test fit the ducts

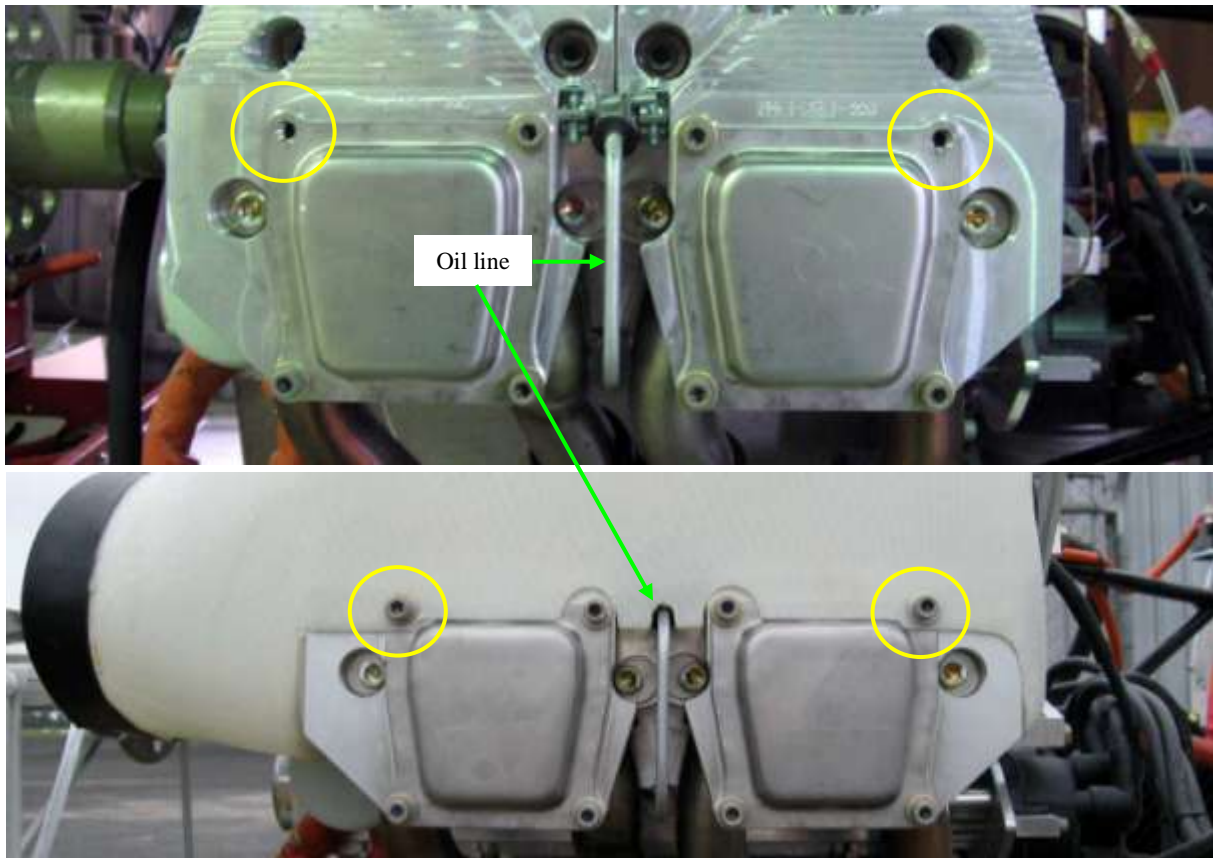

Fitting the ducts will require adjustments to be made in several areas: firstly the oil line to the rockers will need to be accommodated, then the rear baffle and the air dams will need to be adjusted and then the sequence repeated perhaps 2 or 3 times until the fit is correct.

Remove the front and rear rocker cover cap screws (circled top), test fit the duct and mark the locations for the cutouts around the oil line (arrowed above). File out a notch for the oil line until the duct clears it by 1-2mm all round. Leave the cap screws out and set aside until the final fitting of the ducts is complete.



The front air dams will need to be trimmed to fit around the fins on the cylinder heads and barrels. The final fit must have the air dams only just touching the fins as shown above.

It may take few trial fits so take your time and get the fit just right.

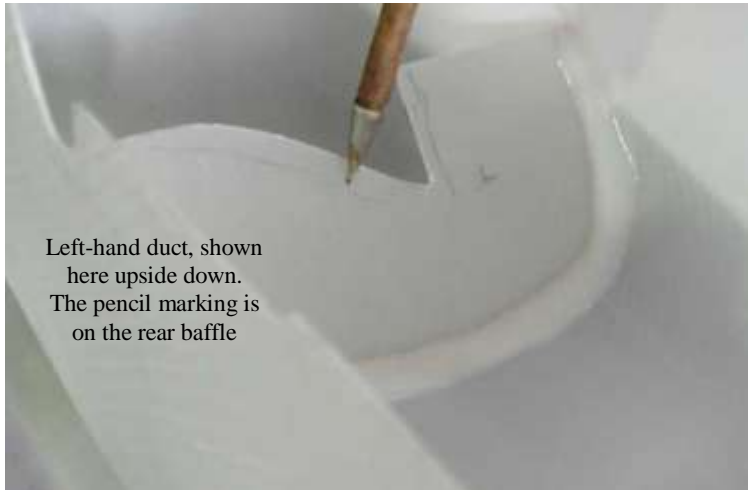

The baffles at the rear of each duct will need to be trimmed to allow the duct to sit down correctly. Test fit and trim until the inside of the duct sits down on the barrels, between the fins as shown above right, and the outside sits just on the top of the rocker covers.

Once the rear baffle and air dams are fitting correctly you can mark and drill both of the rocker cover holes (circled in the photo at the top of the previous page) to $\frac{1}{4}$ " and temporarily mount both ducts using the cap screws.

Mark a point on the inside of the duct directly above each front cylinder and drill a $\frac{3}{32}$ " hole, then flock and rivet the supplied right angle spring bracket into place as shown at right, placing a washer on the rivet inside the duct.



Fit a loop of lock wire around the cylinder between the third and fourth fin and through the bottom of the spring and twist it off.

The spring may be unhooked at the bracket end to remove the duct.



Fit the magneto coil cooling tubes

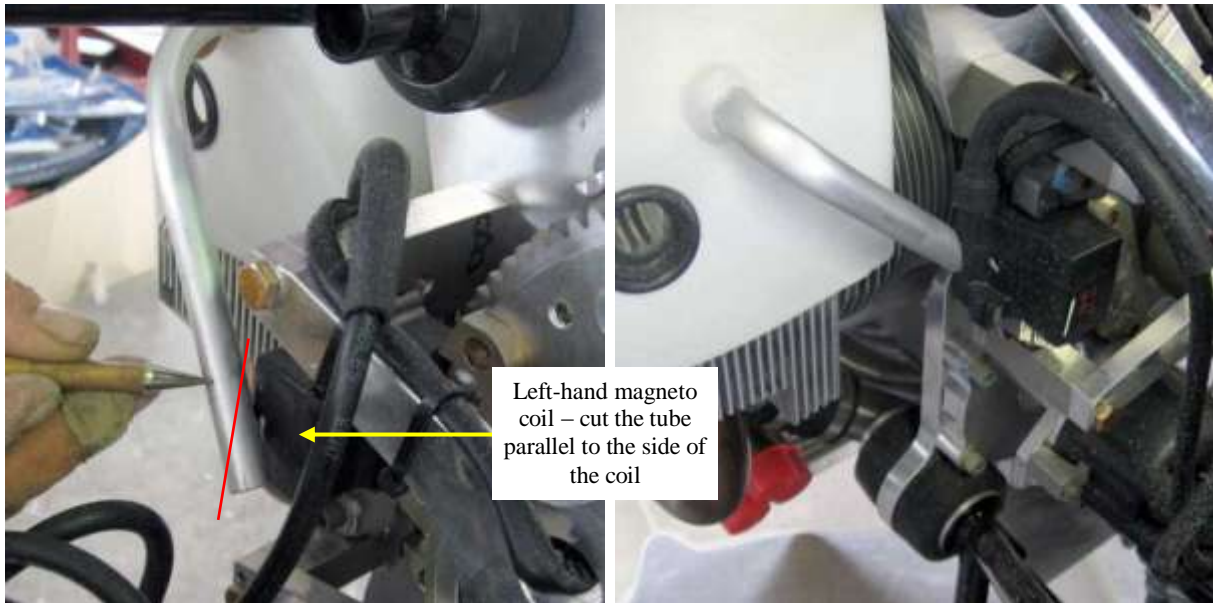

Starting with the left-hand duct, drill a ½” hole at the top centre rear of the duct and slip the curved aluminium tube into place until the mark on the tube reaches the duct. Aim the lower end of the tube at the centre of the left-hand magneto coil, mark the tube at an angle parallel to the side of the coil, remove the tube and cut along the mark. Shorten the top end of the tube as required – it should fit about 1½” to 2” (40-50mm) inside the duct.

Refit the tube to the duct and hold it in position with masking tape. Mix a small batch of 5-minute Araldite and flock and fix the tube to the duct. Leave to cure, then remove the duct and apply flock around the tube on the inside of the duct to provide strength. Leave to cure.

Repeat the procedure on the right-hand duct:

Refit both ducts and leave them in place.



This completes the *Pre-Paint > Fuselage > Firewall forward > Fit ram air cooling ducts* task.

Pre-Paint>Fuselage>Fit windscreen

The windscreen is an integral structural component of the airframe, providing strength and rigidity, and the correct fitting method is very important.

The windscreen is made from strong but brittle Perspex and care must be taken to avoid marking or cracking the windscreen while it is being fitted. The use of sharp or new drill bits must be avoided: use an old drill bit and blunt it before use by drilling into some concrete, and then grip the bit loosely with a pair of pliers while running the drill (see photo at right) to remove any roughness from the flutes that might bind and cause damage to the Perspex.



Any shaping of the windscreen that may be required must be done with an 80 grit sanding disc, and you must *never* use a jigsaw. Photos are of a J200: the same process applies to all.

Materials required:

Epoxy resin and flock

¼ x ¼” adhesive-backed foam strip (not included in kit)

Pre fit the windscreen



Start by carefully sanding away all of the gel coat from the joggle, then fit a length of the ¼” foam strip around the very inside of the joggle (the grey line in the photo above right) – this will keep the flock from making a messy line around the inside of the windscreen and give a nice clean edge when the windscreen has been flocked into place.



Test fit the windscreen, holding it in place temporarily with a strip of cloth tape on each side as shown above. The arrows show the side screw positioning – refer to next page.

Note that the protective plastic cover has been folded back from the edges of the windscreen.

Check around the entire perimeter of the windscreen for any areas where the Perspex does not fit neatly inside of the joggle and carefully sand away the Perspex until it fits. In most cases the windscreen will fit correctly without any alteration, but nonetheless check carefully.

Drill the screw holes

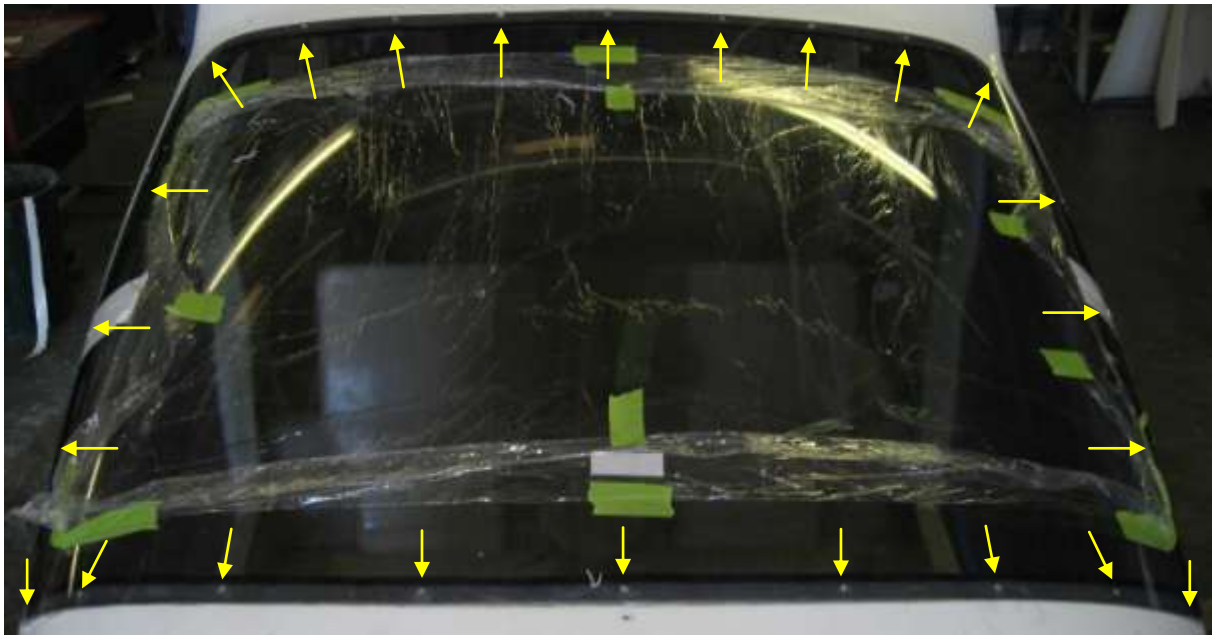

With the windscreen still held firmly in place by the tape, the next step is to drill a series of 11/64" holes around the perimeter at the positions shown above. Note that 11/64" is slightly bigger than the screws – this is to make sure that the threads will not bind in the holes and possibly chip or break the Perspex.

Drill slowly with a blunt drill bit and don't lean on the drill - let the bit do the work.

The holes are drilled well in from the edge of the Perspex at a point where they just miss the 1/4" foam tape – this gives the maximum amount of 'meat' for the screws to grab. Note that the bulk of the structural strength is provided by the flock: the main purpose of the screws is to hold the windscreen firmly and accurately in place while the flock cures.

Start by drilling at each corner, then drill halfway between each corner and then drill halfway between those holes until you have the holes as shown above and on the previous page.

Once all of the holes have been drilled they will each need to be countersunk to a depth where the head of each countersunk M4 x 12 screw will be just below the surface of the Perspex.

Prepare the windscreen

Remove the windscreen carefully and clean away any burrs from around the holes and blow away any dust and debris from the joggle.

Place the windscreen face down on the bubble wrap packing material, taking care not to allow anything to scratch the surface, and sand around the entire inside edge with emery tape – roughen to a point level with the inside of the bolt holes.

By holding the emery tape as shown you can use your finger to control the width of the sanded area.

When the sanding is complete blow away the dust and then use a clean soft cloth and wipe right around the windscreen. Do not use any cleaning agents.



Fit the windscreen



Mix 160 grams of flock and fill the entire joggle up to the level of the foam strip. Carefully place the windscreen onto the bed of flock – start at one corner and position the windscreen with a rivet or similar to get the alignment of the holes and then lower it into position.

Once the windscreen is in place start fitting the screws and locknuts, working from the corners first and then the middle screws and so on in much the same manner as the holes were drilled. Take care not to over tighten the screws, tighten them just enough so that the edge of the windscreen is level with the adjacent fuselage.

Check all around to see that the flock has keyed to the windscreen: the sanded surface of the windscreen edge will appear to go clear with no bubbles when the flock is in full contact with it. It may be necessary to gently squeeze the windscreen to remove any bubbles, although if you have filled the joggle with flock there should be full contact anyway.

In the photo at right you can see that the flock is in full contact all the way around. Note the flock has been wiped off level at the outside of the joggle and that there is no flock at all on the surface of the windscreen.



When you are satisfied that the windscreen is positioned correctly wipe away the excess flock with a clean mixing stick, taking care not to smear any resin or flock over the windscreen: always wipe out and away from the windscreen. Do not use any cleaning agents; use only a clean soft cloth.

Leave overnight to cure.

This completes the *Pre-Paint>Fuselage>Fit windscreen* task.



Pre-Paint>Fuselage>Fit control cables and lines

Objectives of this task:

The rudder, elevator, elevator trim cables, static line and VHF antenna cable, along with any electrical wiring, will be routed from the empennage to the cockpit for later connection.

The **trim** cable will be routed from the front edge of the pilot's seat and into the longitudinal rib and out the bottom of the empennage, the **elevator** cable will be routed from the console through the longitudinal rib and out the rear of the empennage, and the **rudder** cable will be routed beside and into the longitudinal rib and out of the lower console while the rear of the cable runs up through the fin stub.

Cable connections will be performed in the appropriate tasks later in this manual.

Materials required:

Cloth tape

Identify the cables

Each control cable is fitted with a white identification tag permanently attached and a bright orange identification tag just beside it. In every case these tags identify not only the cable but also the inboard or control end of the cable and you should plan to have the tagged ends end up inside the cabin when each cable is finally fitted.

Identify the exit holes in the console

All electrical cabling and the fuel line exit the console at the top front of the lower console, just before the rudder pedals. This slot was enlarged in the *Prepare fuselage* task.

The **trim** cable exits the console at the right front of the pilot's seat against the console.

The **elevator** cable exits the console from the right hand side of the centre armrest.

The **rudder** cable exits the console midway between the front of the pilot's seat and the firewall just above the floor.

Run the electrical cabling and static tube

The rudder cable will be used to push all of the electrical cabling through from the rear of the fuselage and through the holes in the ribs then into the lower longitudinal rib to the wiring hole in the lower forward top of the console.

Use cloth tape to bundle all electrical cabling (2 fuel pump wires, VHF antenna cable, strobe light wires (if fitted)) and static tube to the end of the elevator cable as shown above right. You may want to include a drawstring for any wiring that you decide to add later.



Feed the bundle in from the rear and through the holes in the ribs beside the lower longitudinal rib and into the slot in the lower longitudinal rib under the lateral beam behind the seats and into the lower forward part of the console.



When the bundle is visible in the cable hole at the lower front of the console pull it through until the cloth tape can be removed, then withdraw the rudder cable slightly while holding the electrical cables and the static tube from moving back – tape them to the side of the console if necessary.

Pull the electrical cables and the static tube up until they are level with the top of the windscreen – this will give enough length for later connection.

Use a wire hook to pull the static tube down through the rearmost slot underneath the empennage as shown at right.

The static tube from the static probe in the vertical fin will be routed down and through the same slot and a joiner will connect the 2 tubes – both tubes can be seen in the photo at right, tied together to prevent them slipping back into the empennage.



The VHF antenna cable and the strobe wiring can be left trailing out the rear of the fuselage at this point – they will later be routed up into the vertical fin. The 2 fuel pump wires can be coiled up behind the seats for later fitting into the header tank enclosure, and any wingtip strobe wiring can be coiled in the same position for later connection.

Fit the trim cable

Feed the trim cable (untagged end first) in through the hole in the front edge of the pilot's seat and feed it back into the longitudinal rib (you may need to use a wire hook through the access slot behind the seats to lift the cable over the main gear hump) until it can be seen through the front slot under the empennage, then hook it out of that slot (the rear of the trim cable can be seen in the photo above right) and pull it through until it is roughly level with the trim horn.



Fit the elevator cable

Feed the elevator cable (untagged end first) into the slot on the right-hand side of the armrest and back through the longitudinal rib.

You may need to use a wire hook through the access slot behind the seats to lift the cable over the main gear hump.

Feed the cable back and out the "T" shaped hole at the lower rear of the empennage.



Clamp the elevator cable into place using the supplied clamp bracket, taking care to fit the pressed locating section of the clamp in the groove around the outer cable. The clamp consists of a saddle and a backing plate, and the whole clamp must be fitted onto a tapered profile plate with the thin end of the wedge facing the rear of the aircraft and secured to the fuselage by 2 x AN3-6A bolts and Nyloc nuts. Tighten firmly.



Fit the rudder cable

The rudder cable was partly fitted with the electrical cabling, so all that is left to do is to feed the rear of the cable up and out of the slot on the right hand side of the fin stub, as shown at right: the photo has been taken from the rear of the empennage looking forward.

The front of the rudder cable can be seen inside the console near the rudder slot on the left-hand side of the lower console, so use a hook to pull it through the slot and pull it about 150mm through and into the cabin footwell.

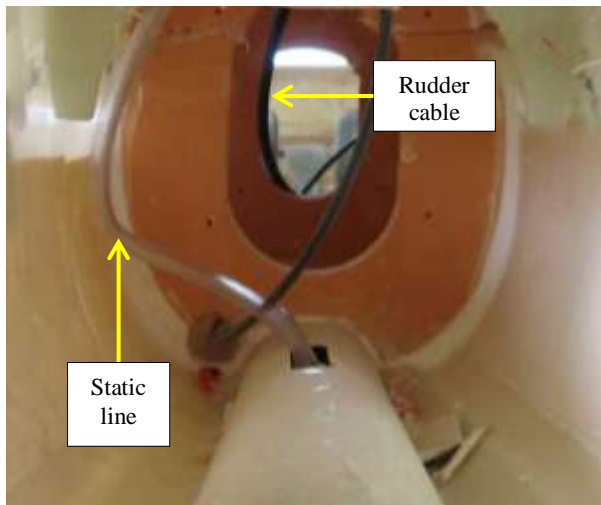

This completes the *Pre-Paint>Fuselage>Fit control cables and lines* task.

Pre-Paint>Fuselage>Empennage>Fit vertical tail fin

Objectives of this task:

To fit the vertical tail fin to the fuselage, including fitting the static probe, static tube, optional strobe light wiring and the VHF antenna coax cable.

Materials and equipment required:

Card # J3 'Rudder' for the VHF antenna

Glass cloth and peel cloth bags labelled: "Tail Fin" and "Outer Reo Tail Fin"

Epoxy resin and flock

5-minute Araldite and flock

2 lengths of 2" aluminium angle, waxed, each one at least the length of the join

Plumb bob and string line

Builders level



Completed vertical fin fitted to the fuselage

Fit the spar extender

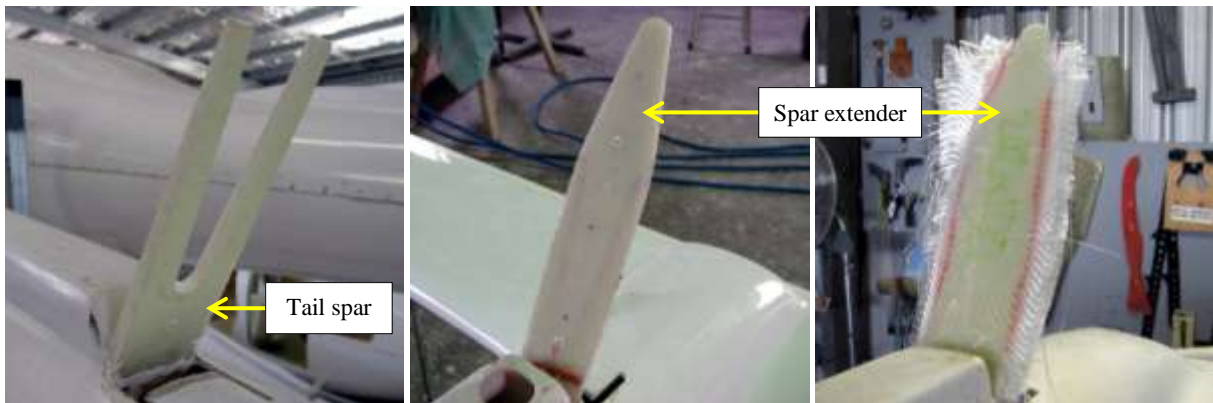

Sand the matching surfaces of the pre-fitted tail spar and the spar extender. Make sure that the 2 pieces match and then fix the spar extender in place with 5-Minute Araldite.

When the Araldite has cured sand the front and back surfaces of the spar, mix a batch of resin and coat both surfaces and then brush on 3 layers of AF303 glass fibre cloth to each surface (front and back) and finish with a layer of peel cloth.

When ready to fit the fin remove the peel cloth and carefully trim the glass cloth from the sides of the extended tail spar. A heat gun will make the edges of the cloth easier to trim with a sharp knife.

Prepare the vertical fin



Start by laying the vertical fin on its side and drilling out the marked inspection hole on the left-hand side with a hole saw.

Turn the vertical fin over and cut out the marked slot for the rudder cable: drill each end of the slot then use

a jigsaw to join the two holes.

Remove any burrs – the exact sizing of the hole and slot will be finalized once the vertical fin has been fitted into place.

Remove the peel cloth from both sides of the joining surface. Use a scraper to remove any edge strips of the peel cloth that have not peeled off cleanly.



Using a round file, enlarge the static probe mount hole in the top front of the fin – it needs to be large enough to pass the static tube and draw wire through easily. The finished hole size is not critical. Take care not to file through the pre-installed drawstring: for this reason using a drill is not recommended. If fitting the optional strobe to the top of the fin then you should fit the mounting base now: flock the base to the forward top of the fin and screw in place.

Pull the static tube and the VHF cable through the fin

Lay the vertical fin beside the fuselage on trestles set at about the same height as the fin mounting stub. Lay the strake across the mounting stub.

Locate the drawstring inside the fin that will be used for the VHF cable and the static tube – it is tied in a loop around the internal foam rib. Cut the bottom of the loop to separate the drawstring into 2 parts: the static tube/strobe wiring and the VHF cable.

Run the static tube/strobe wiring up from the fuselage into the rear section of the fin, **through** the hole in the internal foam rib and into the front section of the fin – do **not** let the static tube lay under the rib or it will be squashed against the stub when the fin is fitted. *This is critical!*

Tie a length of wire to the static tube drawstring and pull it through – the friction of the static tube being pulled may cause a string to break.

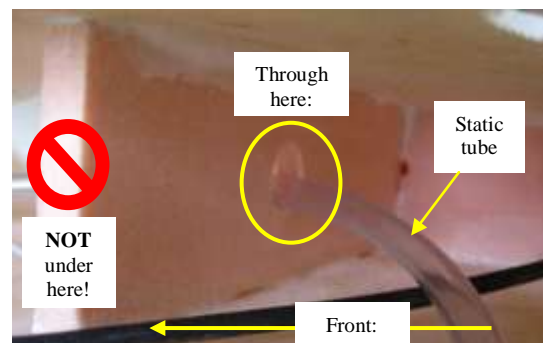

Tie the drawstring to the VHF cable and the draw wire to the static tube/strobe wiring. The photos below show how: loop the draw string or wire around the cable or tube to be pulled then tape the end of the draw wire or string so that when it is pulled it will tighten the knot. Tape the end of the cable or tube to be pulled to streamline it and avoid it catching on anything. Cloth tape is stronger than masking tape and is recommended for this purpose.



Pull the static tube/strobe wiring and the VHF cable through the fin and out of their respective holes, then tie a knot or tape a mixing stick across the end at right angles to prevent them sliding back inside the fin.

Test fit the vertical fin

Tape the rudder cable threads then push the cable forwards until it can be tucked inside the slot in the mounting stub. Lift the fin up and over the tail spar and slide the fin down into place. You may have to trim a small amount out of the fuselage behind the tail spar to clear the fin spar. A jigsaw is ideal for this task.



Check the fit along the entire joining line and mark and remove as required to achieve a good fit. Take extra care to ensure that the join at the front of the strake (at the yellow arrow in the photo below) is smooth so that there is one continuous line along the entire length of the strake – if there is any discontinuity it will look extremely disappointing when paint is applied so take care to get it exactly right at this time.

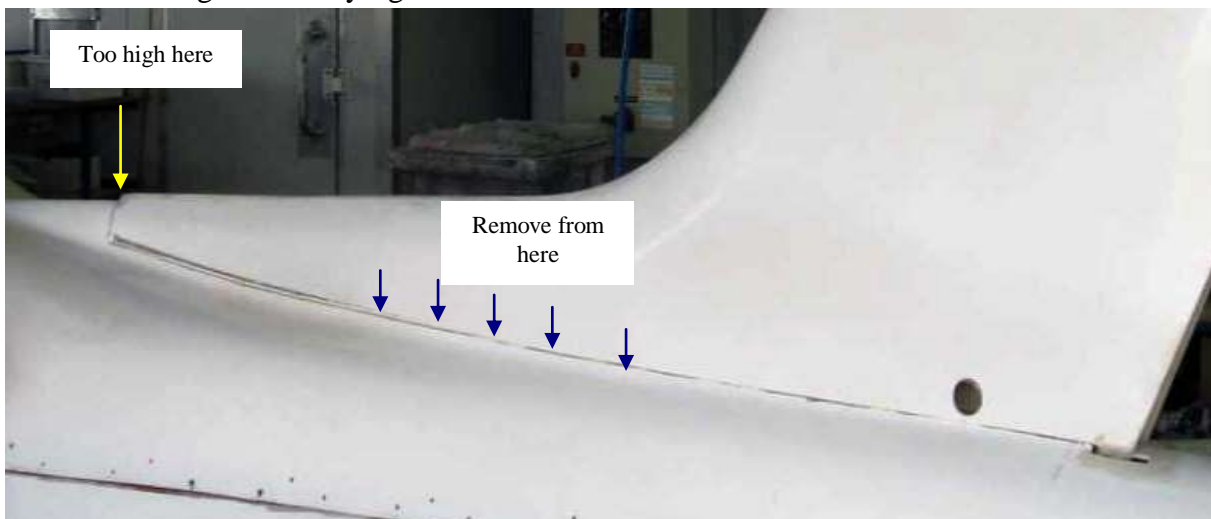



Level the aircraft

Because the alignment of the vertical fin is important the aircraft should be fixed in a “wings level” attitude prior to the final fit. Place a 3” block on the top of each front wing mounting lug and place a spirit level across the top of the cabin so that it rests on both blocks. Pack the main wheels as required to level the aircraft.



Fit the vertical fin

You will need a second person to help you position and fit the vertical fin.

When you are satisfied that the fin will fit correctly, prepare the mounting stub on the fuselage by sanding all of the gel coat from the surface of the joggle.

Lightly sand the inner surface of the vertical fin and the mating surfaces of the tail spar and fin spar.

Mix a batch of resin and carefully coat all surfaces to be joined. Add flock and mix, then apply a 3 – 5mm coat to one side of all surfaces to be joined: both sides of the mounting stub and the back of the tail spar.



Do not be overly concerned about getting a precisely even layer of flock – the pressure of the 2 surfaces being squeezed together will ensure that the flock is evenly distributed.

With one person holding each side of the vertical fin, lift the fin into position and lower it down while holding the sides of the fin apart as shown below.



Take care not to let the fin just slide down into place because it will push all the flock out of the join, and do not let the fin slide down past the joggle! You may want to fit 2 x self-tapping screws at either side of the rear of the empennage just where the joggle steps out to prevent this happening.

When the fin is all the way down push the fin all the way forward and allow the sides to push in and onto the flock. Check the fit, particularly at the strake/fuselage join.

Tie a plumb bob to a string line and fix the string line to the top of the vertical fin then align the fin until it is *precisely* vertical: the string line should be exactly in the centre of the fin when viewed from the rear. **Recheck this vertical alignment** at every step from here on.



Once the alignment is correct, secure the fin in position. You could use a strip of heavy adhesive tape from the outside edge of the horizontal fin, over the top of the vertical fin and down to the other side of the horizontal fin. **Recheck the vertical alignment.**

Now hold the fin forward and fix the fin spar to the tail spar with 2 self-tapping screws as shown at right. **Recheck the vertical alignment.**



Rivet the front of the strake into place with a countersunk pop rivet at each side of the strake and then rivet at each side of the inspection hole and the rudder cable and remove the self-tapping screws. **Recheck the vertical alignment.**

Wax one side of each of 2 lengths of aluminium channel so that the flock will not stick and place as a rail along each side the full length of the join line and secure with clamps as shown below. **Recheck the vertical alignment.** Leave overnight to cure.



Next day remove the aluminium channels and the peel cloth, then use a hole saw to open the inspection hole and a drill and jigsaw to recut the rudder cable slot. File out any rough edges.

Fit the VHF antenna

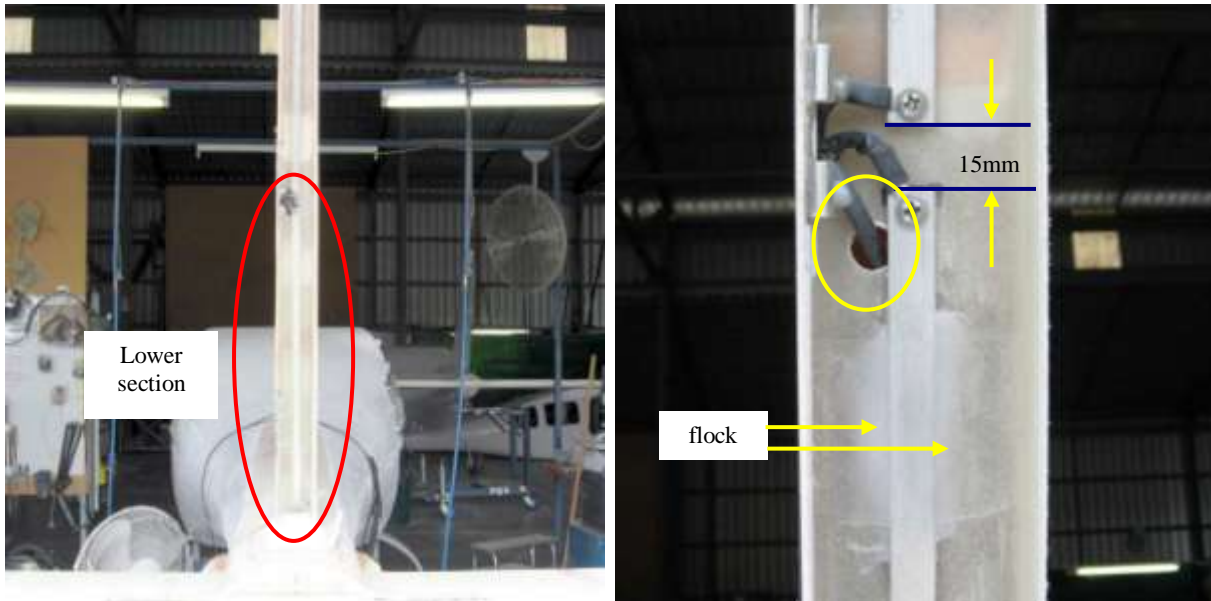

Ensure that the VHF coax cable exit hole is on the hinge (left-hand) side of the vertical fin – elongate the hole with a file if it is not. Sand the back of the lower section of the VHF antenna and place it so that it is exactly 15mm below the upper section and fix it in place with 5-minute Araldite.

Note that the factory fitted upper section of the antenna has been offset slightly to the left to allow for rudder movement: keep the lower section of the antenna exactly in line vertically with the upper section.

Ensure that the threaded hole for the electrical connection is at the top of the lower section as shown above right.

Mix some resin and lay up 2 pieces of glass fibre cloth across each section of the antenna in 3 places, using flock to fill the gaps at each side of the antenna before placing the cloth. Leave overnight to cure.

Next day, shorten the VHF coax cable to length, and fit ferrite toroids, crimp 4.5mm electrical ring terminal connectors to the inner cable and the outer coax sheath and fit heat shrink tubing over the terminal joins, as shown in the sketch below.

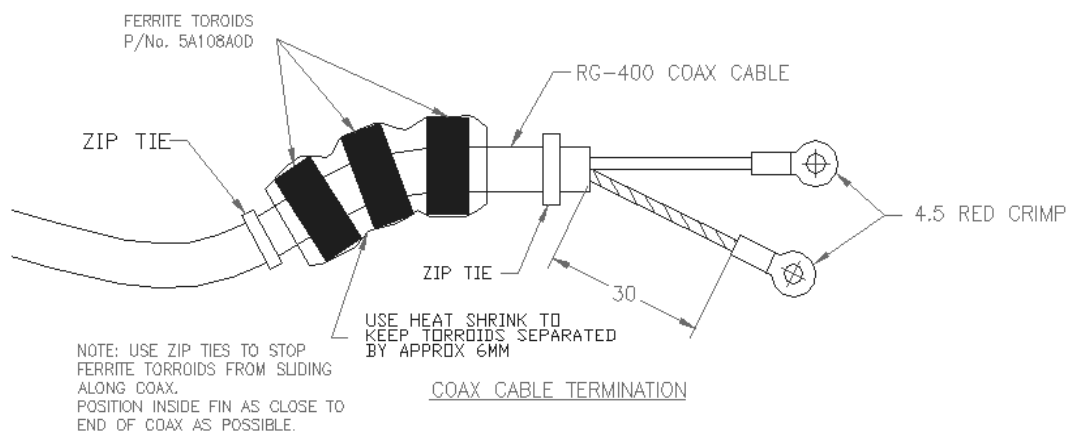

Screw the inner cable to the TOP section and the braided coax sheath to the LOWER section. Tuck any excess cable back into the vertical fin and seal completely with silicone sealant.

Fit the static probe assembly

Assemble the static probe: using a drop of Loctite fit the bullet-nose end to the static tube, making sure that the vent hole (circled) will be horizontal when the static probe is installed.

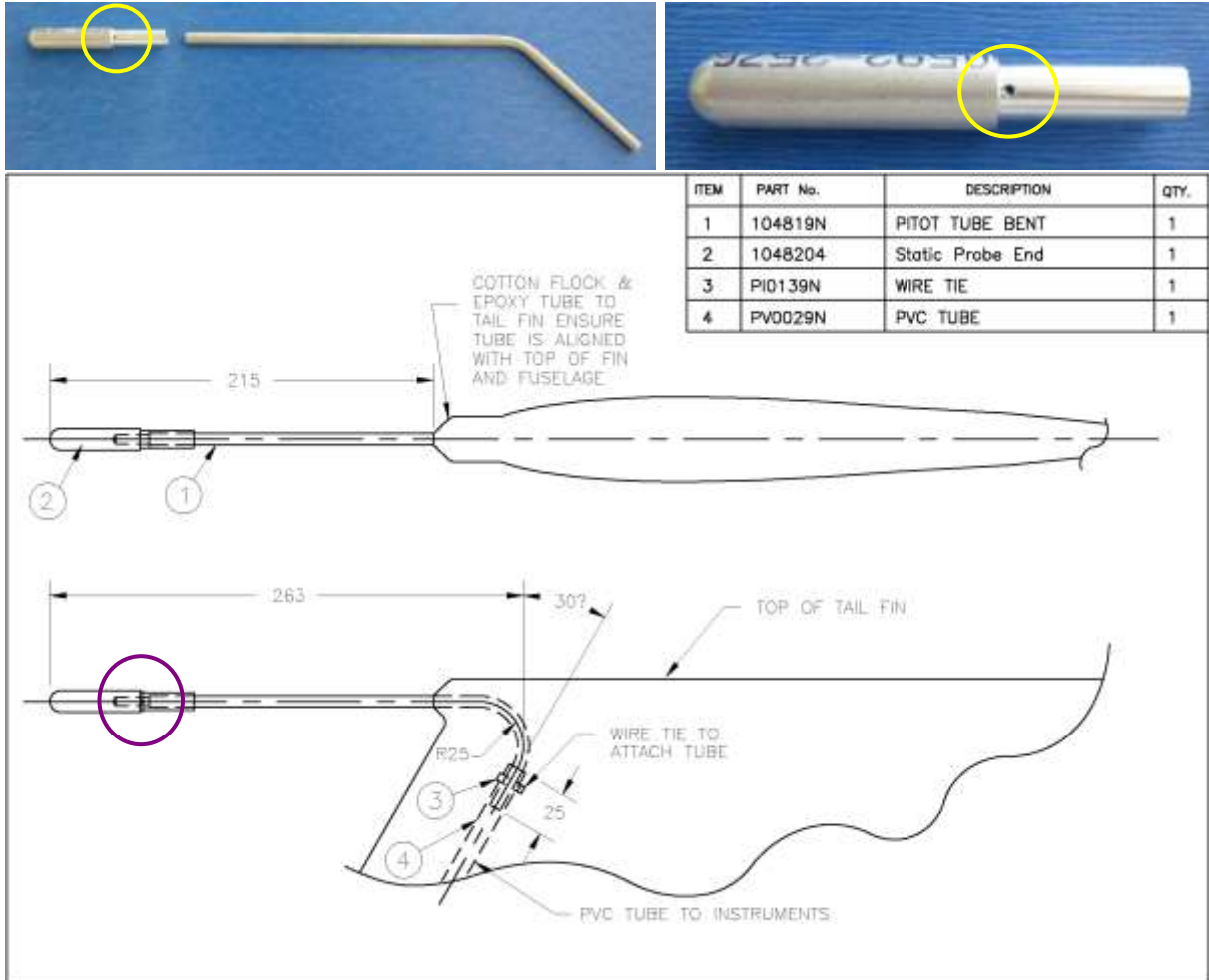

Put a smear of super glue around the base of the static tube then slide the PVC tube over the base of the static tube by at least 25mm and fix firmly in place with 2 lock wire ties.

Take particular care that the PVC tube is well secured to the static tube because once the static probe assembly has been flocked in place there will be no access for repair work.

Push the static probe assembly back into the hole at the front top of the vertical fin so that the static probe assembly is parallel with the top of the vertical fin and centred laterally in the fin.

Secure the static probe assembly in place with 5-minute Araldite and hold it in place while the Araldite dries. Mix up a batch of resin and coat the area around the base of the static probe assembly, and then add some flock to make a firm mix and shape around the base of the static probe assembly to form a smooth transition from the static probe to the fin. Leave to cure overnight and then sand to a smooth tapered finish.

This completes the *Pre-Paint > Fuselage > Empennage > Fit vertical fin* task.

Pre-Paint>Fuselage>Empennage>Fit elevator

Objectives of this task:

To fit the elevator to the horizontal stabiliser, to fit the trim tabs to the elevator and the end caps to the elevator and the horizontal stabiliser.

This task is performed on trestles prior to the fitting of the horizontal stabiliser to the fuselage.

The trim tabs and end caps may be fitted after the horizontal stabiliser and elevator have been fitted to the fuselage, although it is usually easier to fit them as part of this task.

Materials required:

Card # J17 “Elevator” for the hinges

Epoxy resin and flock

Prepare the horizontal stabiliser and the elevator

Remove the peel cloth from the horizontal stabiliser and the elevator.

Mark the top and bottom of the horizontal stabiliser and the elevator: the horizontal stabiliser is pre-marked and the drive arm of the elevator must face downwards.

Lay the horizontal stabiliser and the elevator on the work surface in the finished position with a 1mm gap (use 2 equally spaced mixing sticks) between them. You will need to place a wedge under the rear of the elevator. Make sure that that the ends are aligned and then measure and mark a centreline on each surface. Lightly clamp or tape the horizontal stabiliser and the elevator in position.

Mark and drill the elevator hinges

Mark out the hinge positions: mark the centreline of the tailplane and then use the drawing on the next page and mark the correct hinge locations, which will be the same on each side.

Place the hinges in those locations with the flat side of each hinge facing upwards and the hinge pin aligned in the centre of the gap between the horizontal stabiliser and the elevator.

Do **not** place the hinge flat side down – if you do then the holes will not line up correctly when you come to fit the hinge.



Use a 3/32” drill to make a pilot hole opposite the pin side of each rivet hole: this is to allow for the slight slope of the hinge at this point, then check that the hinge and hole positioning is correct and then carefully expand to 3/16” holes.

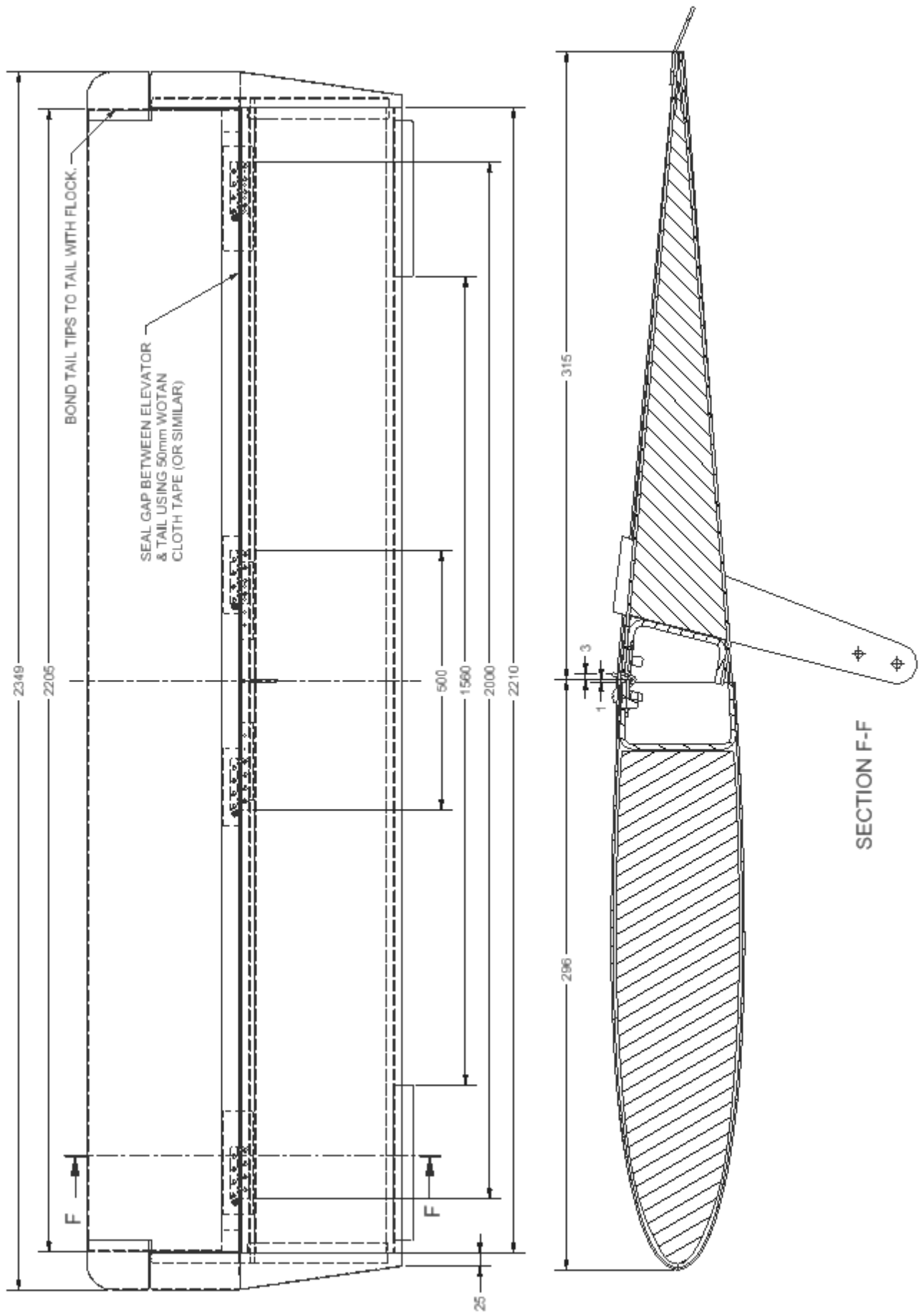

Fit the elevator hinges



Test fit the hinges using 2 Clecoes per side and slide the hinge pin into place as shown above.

Fit the 2 outer hinges first – this will hold the elevator in place while the inner hinges are fitted.

Each hinge pin is inserted from the inside towards the outside of each hinge. Mark the location of the end of each hinge pin (circled at above right). Check that the elevator can swing freely with no binding in the hinges: adjust the hinge mounting holes if required.

Check that the horizontal stabiliser to elevator gap is even along the full length then remove the elevator and hinges. Leave the horizontal stabiliser clamped down.

Sand the flat side of each hinge and the locations where they will be fitted, then mix a small batch of resin and coat each area. Add flock to the remaining resin and apply a 2mm layer of flock to each hinge and flock into place using clean Clecoes in the outer holes as before.

Using a 120° countersink bit carefully countersink the 4 inner holes just enough so that a countersunk rivet head will sit flush with the surface when fitted and rivet the 4 inner holes with countersunk rivets. Now remove the Clecoes from the outside holes one at a time, countersink each hole and fit a countersunk rivet until each hinge has 8 countersunk rivets.

Take care to keep flock away from the hinge pins during this step: clean the hinges while the flock is still wet and then separate both parts (horizontal stabiliser and elevator) and leave overnight to cure. Clean the Clecoes in acetone after use.

Next day use a rat tail file to make a slot into the horizontal stabiliser at each hinge pin mark (example circled at above right), fit the hinge pin and the hinge pin retainer, mark the retainer screw hole and drill a 3/32" hole. Pop rivet an anchor nut under each screw hole using 2 x 3/32" countersunk rivets. The drawing on the previous page shows detail.



Fit the trim tabs

Mark the trim tab locations on the elevator from the dimensions given on the drawing on the previous page. Note that the trim tabs fit onto the top of the elevator and face downwards.

Clamp the trim tabs in position using spring clamps and drill the 3 holes as shown on the drawing. Lightly sand the surfaces to be joined, then mix a small batch of resin and coat the surfaces to be joined. Add flock to the resin and stir in thoroughly, then apply a 2mm layer of flock to each trim tab and fit into place with 3 x 6G self-tapping screws.

Clean away any excess flock with the mixing stick, leaving a smooth radius around the entire join, and leave overnight to cure. Next day heat and remove the self-tapping screws.

Fit the elevator end caps

Assemble the horizontal stabiliser and the elevator by inserting all of the hinge pins and set the elevator to a level position.

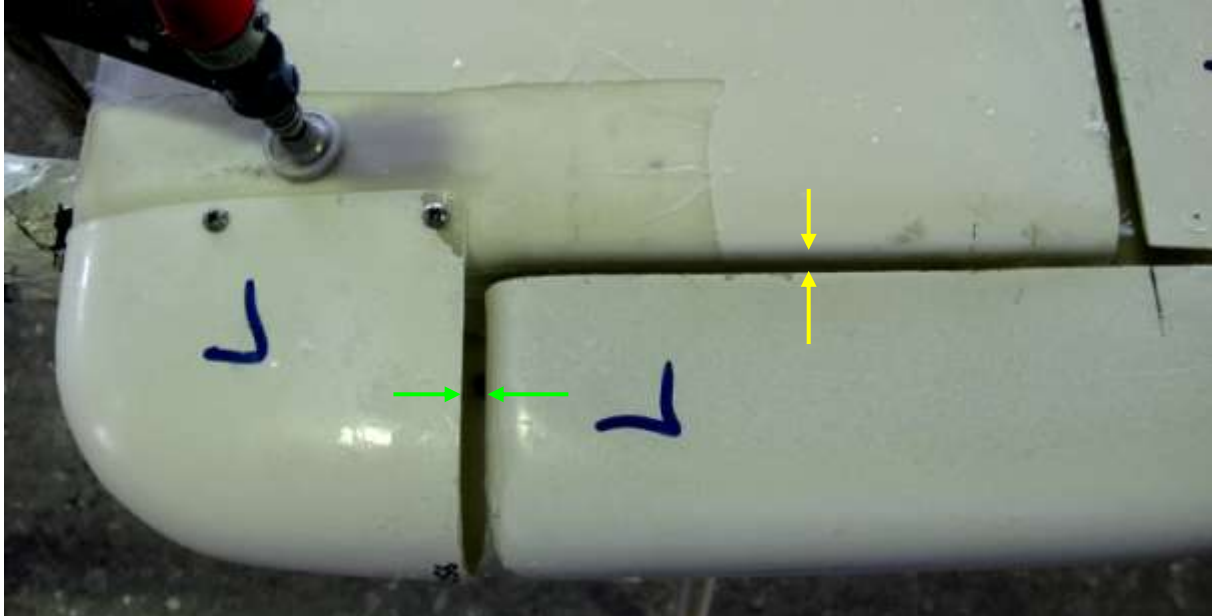

Use a knife to trim out some of the foam in the end of the elevator and then test fit each end cap. Ideally you want a gap between the end of the horizontal stabiliser and the elevator end cap (**yellow** arrows above) the thickness of 2 mixing sticks. When this gap has been achieved, align the rear of the end cap with the rear of the elevator and fit with self-tapping screws. Check that the elevator can swing freely: if there is any binding or rubbing between the end cap and the horizontal stabiliser locate the source and fix it, either by moving the end cap position slightly or by sanding away part of the inside of the end cap.

Remove the end caps and sand all surfaces to be joined, then mix a batch of resin and coat the surfaces to be joined. Add flock to the remaining resin and apply a 2mm layer to the end cap stub then fit the end cap to the elevator and fix in place with the self-tapping screws. Smooth away any excess flock with a mixing stick, recheck the alignment and leave overnight to cure. Next day remove the self-tapping screws.

Fit the horizontal stabiliser end caps

With the horizontal stabiliser and the elevator still assembled, test fit the horizontal stabiliser end caps: the gap between the elevator end cap and the horizontal stabiliser end cap should also be the thickness of 2 mixing sticks (**green** arrows above). When this is correct fit the end cap with 3 self-tapping screws: 1 at each back corner and 1 at the leading edge. Check for freedom of movement then remove the end cap and prepare the surfaces and flock the end caps into place and fix with the self-tapping screws. Smooth away any excess flock with a mixing stick, recheck the alignment and leave overnight to cure. Next day remove the self-tapping screws.

Separate the horizontal stabiliser and the elevator. The horizontal stabiliser will be fitted to the empennage in the task *Pre-paint>Fuselage>Empennage>Fit horizontal stabiliser* and the elevator will then be fitted to set the up and down stops.

This completes the *Pre-Paint>Fuselage>Empennage>Fit elevator* task.

Pre-Paint>Fuselage>Empennage>Fit horizontal stabiliser

Objectives of this task:

To fit the horizontal stabiliser to the fuselage and glass it in place. Note that the elevator hinges were fitted in the previous task *Pre-Paint>Fuselage>Empennage>Fit elevator*.

Materials required:

Epoxy resin and flock

Glass fibre cloth and peel cloth in the bag labelled: “*Horizontal Stabiliser*”

Steps

1. Level the aircraft
2. Fit the stabiliser
3. Glass the stabiliser

Level the aircraft



The aircraft should be fixed in a “wings level” attitude prior to fitting. Place a 3” block on the top of each front wing mounting lug and place a spirit level across the top of the cabin so that it rests on both blocks. Pack the main wheels as required to level the aircraft.



Clamp a straightedge (a 2 or 3 metre length of aluminium angle works well) across the back of the door frames at the height of the fuselage join line: ensure that the straightedge is level. This will be your main reference for aligning the horizontal stabiliser.

Fit the stabiliser

Prepare the stabiliser by taping up the inboard elevator hinges to prevent any resin getting into the hinge pins. From the previous task you will have a marked centreline on the stabiliser: test fit the stabiliser to the rear of the fuselage using the stabiliser centreline as a lateral location guide against the fuselage centreline.



Push the stabiliser fully forward into the rear of the fuselage and check that each end of the stabiliser is an equal distance back from the straightedge – use 2 tape measures as shown circled above, one each side, and carefully move the stabiliser until the measurements are exactly the same. (The photos above show a 200 series fuselage but the principle is the same.)

Sight along the fuselage from the rear and confirm that the stabiliser is level and lined up with the straightedge. The chord line of the stabiliser is to be angled down 3 degrees at the leading edge. Make any adjustments necessary.

When the stabiliser is aligned correctly, secure the stabiliser to the fuselage with self-tapping screws, using 10 screws per side. These screws will be removed after the stabiliser has been finally fitted. Run a pencil line around the stabiliser along the fuselage join.

Remove the stabiliser from the fuselage and remove the peel cloth from the rear of the fuselage, then lightly sand all the surfaces to be joined – the pencil line on the stabiliser will act as a guide for where to sand and where to coat with resin.



Mix a batch of resin and divide into 2 parts. Coat all the surfaces to be joined. Add flock to one part of the resin and apply a layer to the rear of the fuselage then slide the stabiliser in to place, pushing it fully forward. Open the joint and use a mixing stick to force flock into the sides and rear of the joint, then smooth the flock along the outside. Fix the stabiliser in place with the self-tapping screws, do a final check of the alignment and leave overnight to cure.

Next day, remove the self-tapping screws that were used to temporarily fix the stabiliser in place. If they are difficult to remove heating each screw with a soldering iron will help.

Glass the stabiliser

In this step the hole at the fuselage join at the front of the stabiliser will be glassed over with 3 layers of AF303 glass fibre cloth.

Start by lightly sanding all surfaces, then mix a batch of resin and coat the surfaces where the glass fibre cloth will be placed.

Cut 6 squares of AF303 glass fibre cloth (3 per side) to cover the root of the join as shown at right and brush each layer into place.

Brush a layer of peel cloth over the join and leave overnight to cure.

Next day remove the peel cloth and trim away excess glass fibre ends with a sharp knife.



This completes the *Pre-Paint>Fuselage>Empennage>Fit horizontal stabiliser* task.

Pre-Paint>Fuselage>Empennage>Fit rudder

Objectives of this task:

To fit the rudder to the vertical fin, align the rudder and fit the rudder stops and rudder cable.

Materials required:

Card # J3 'Rudder'

Epoxy resin and flock

Align the rudder

The first step is to line up the top of the fin and the top of the rudder: the vertical alignment.

Tape a mixing stick to the fin at the 2 positions indicated by the yellow arrows at right and sit the rudder in place.

Place mixing stick(s) as required at the bottom of the rudder to get an even gap.

It may be necessary to adjust the vertical gap slightly or sand the top of the fin or rudder in order to get a precise and visually pleasing alignment.

Once the vertical alignment is correct the fore and aft alignment can be addressed: the second step is to equalise the gaps between the fin and rudder and the top of the fin and the rudder horn.

It may be necessary to sand part of the forward section of the rudder horn and/or the back of the fin ahead of the rudder horn away, taking care not to make either area too thin.

Take your time and get this alignment exactly right – the tail fin/rudder is a very visible part of an aircraft and time spent now will reward you with the pleasure of a great looking tail on your aircraft. Leave the mixing stick alignment spacers taped in place at this stage.

Use the photo of a finished example above as a guide of how the rudder should look.



Pre fit the hinges, mount and swing the rudder

Mark the initial hinge locations onto the vertical fin from the drawing 2 pages down, then number the hinges on both sides as well as the matching positions on the fin, including an arrow for "up" on each hinge.

Notice that the flat side of the hinge faces out.

With the rudder still in place, hold each hinge centred over the gap between the vertical fin and the rudder and mark the final mounting position of each: the hinge pin should sit in the centre of the fin to rudder gap.



Remove the rudder and set it aside while the hinges are fitted to the tail fin.

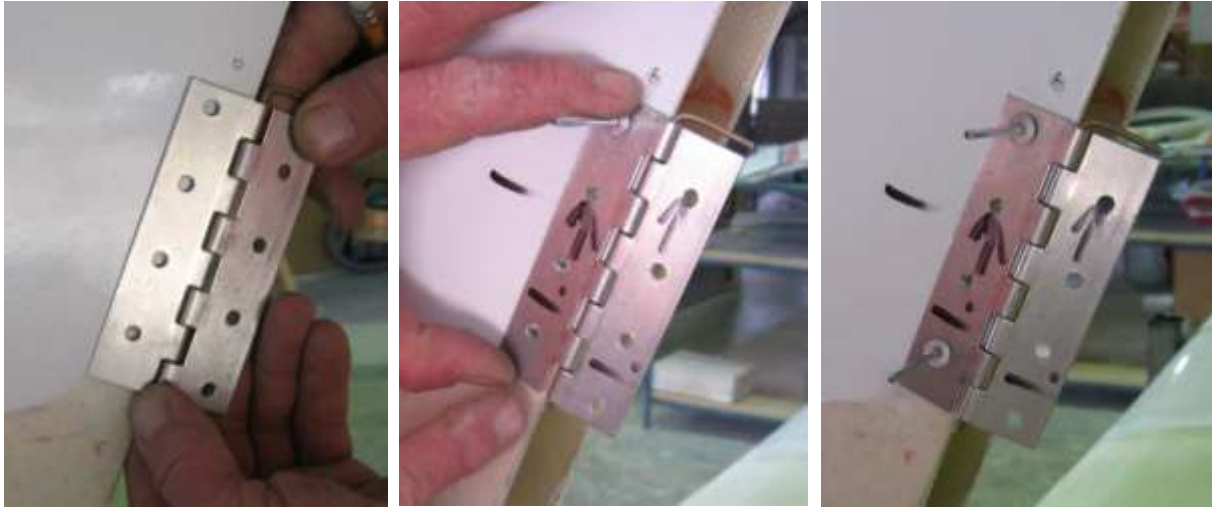

Hold a hinge in position and drill the top hole only and temporarily fit the hinge in place with a rivet as shown above, then carefully reposition the hinge so that the hinge pin is parallel to the back of the rudder and drill the bottom hole and fit a rivet in that hole, then drill the remaining 2 holes. Repeat this process for each hinge.

Put the rudder back in place using the spacers that you left taped in place. Make sure that the alignment is still correct, then drill the top hole of the top hinge and fix in place with a rivet, and then drill a hole in the bottom hinge and fix that in place with a rivet. Repeat the process until all holes are drilled and each hinge is temporarily fixed to the rudder with 2 rivets.

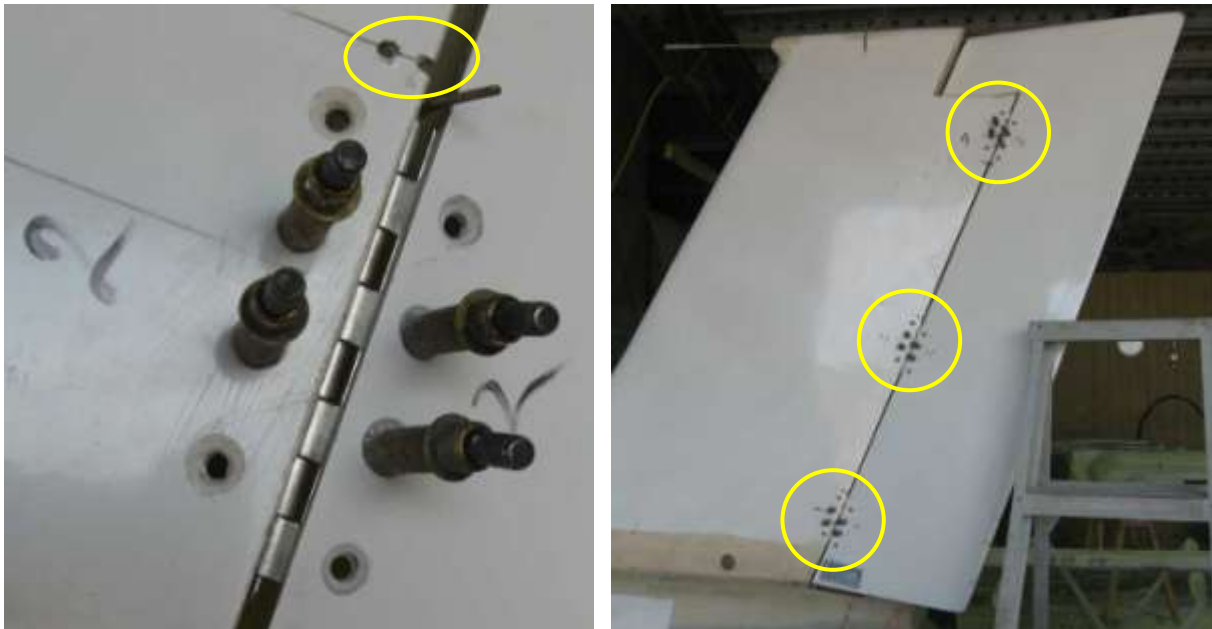

Test fit the rudder using Clecoes to hold each hinge in the final mounting position, which is inside the fin and inside the rudder as shown above. Remove the spacers and check that the rudder can swing freely left and right at least 100mm from the centreline as measured at the rear of the rudder. If there is any binding locate the source and correct it.

Mark the location of the end of each hinge pin (circled at above left), then remove the rudder and all hinges.

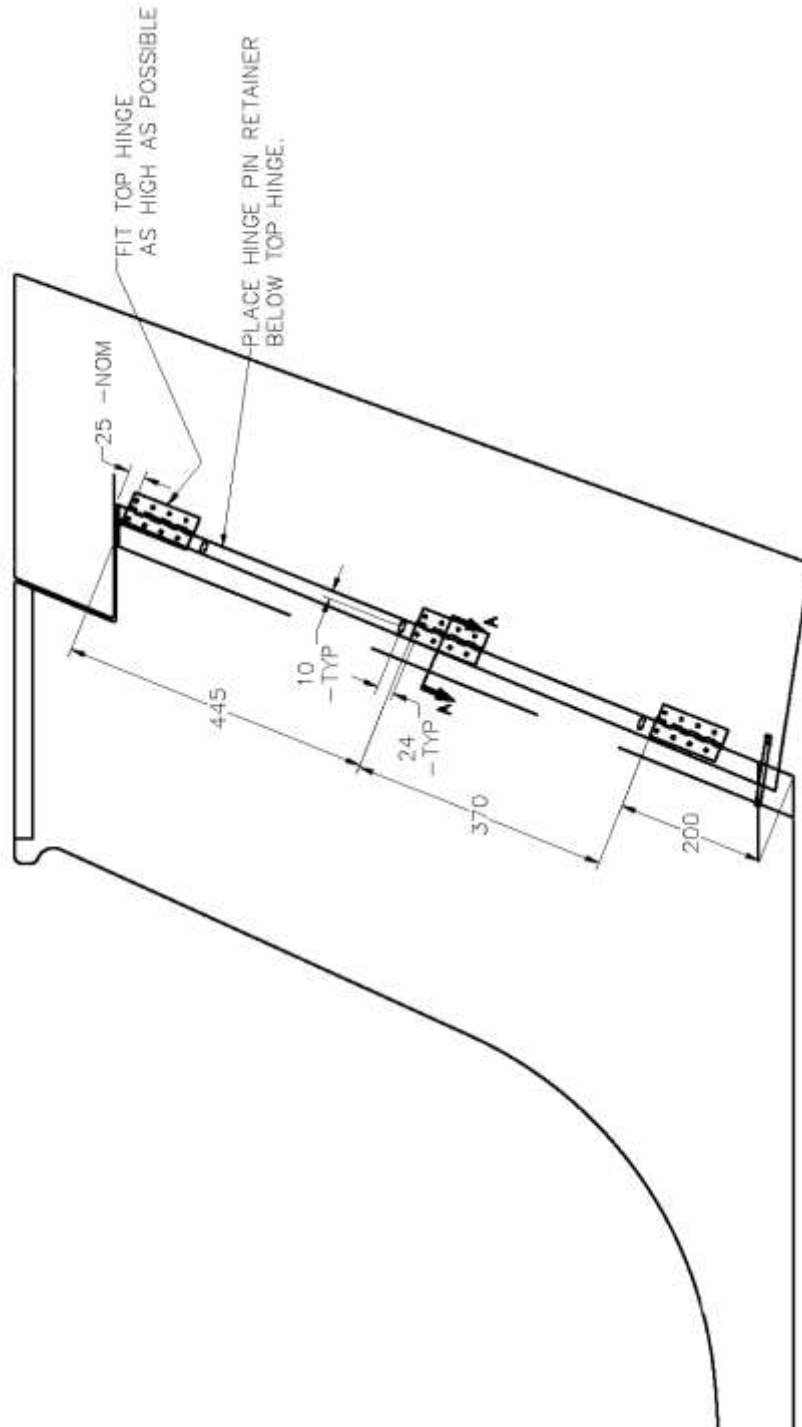

Fit the rudder

The objective now is to refit the rudder as before with Clecoes but with a 2mm bed of flock under each hinge, do a final check of the alignment and rivet the hinges into place.

Lightly sand the flat side of all hinges and the inside of the fin and the rudder where the hinges will be placed. Mix a batch of resin and coat the hinge mounting areas inside the fin and the rudder, then mix in flock and coat the fin half of each hinge. Clecoe the hinges in place on the fin as before. Now apply flock to the rudder half of each hinge and mount to the rudder in the same way: with Clecoes in the centre holes.

Check the rudder for free movement and once you are satisfied that there is no binding then countersink each hole with a 120° countersink bit and rivet each hinge with countersunk rivets – top and bottom holes first, rechecking for free movement at each step, then take the Clecoes out and countersink and rivet the centre holes. Take care to keep any flock away from the hinge pins during this step.

Do a final check for free rudder movement, then carefully remove the hinge pins and rudder, clean away any excess flock with a clean mixing stick and leave overnight to cure.

Next day use a rat-tail file to make a slot into the fin at each hinge pin mark, fit the hinge pin and the hinge pin retainer, mark the retainer screw hole and drill a 3/32" hole. Pop rivet an anchor nut under each screw hole using 2 x 3/32" countersunk rivets.

Fit the rudder stops



Make a template that will sit over the rear of the empennage and tape it in place. Find the centreline of the fuselage and mark a 5mm offset to the right onto the template, then mark 80mm each side of the offset as shown above. Refit the rudder.

Swing the rudder to the left-hand mark on the template and mark the position of the rear rudder stop and fit it in place with 2 countersunk self-tapping screws. Swing the rudder to the right and fit the front stop the same way. It may be necessary to sand inside the right-hand side of the fin to clear the rudder at full right deflection.

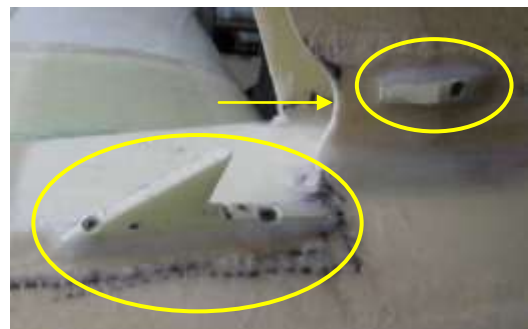

It may also be necessary to sand away part of the lower right of the fin (arrowed at right) to allow clearance for the rudder arm at full right rudder deflection.

Check the swing both ways and adjust the stops if required. Once the positions are correct remove the stops and sand the base of each stop as well as the position in which they will be mounted, then mix a small batch of resin, coat the joining surfaces and flock both stops in place, holding each in place with the self-tapping screws. Smooth away any excess flock and leave overnight to cure.

Fit the rudder cable bracket clamp

Fit a rod end to the rudder cable: thread it on to half the thread depth. The total cable travel is 80mm: pull the inner cable all the way out and make a mark at 40mm from the outer cable then push the inner cable in to that mark. This puts the cable at the centre of its travel.

Fit the rod end to the rudder arm with a bolt.

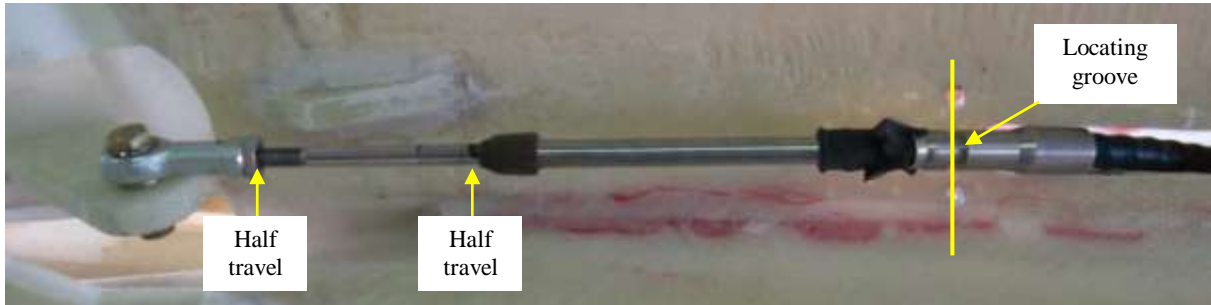

Secure the rudder in the '5mm right of centre' position on the template, then hold the rudder cable horizontal and mark the location of the locating groove in the outer cable.

Hold the cable clamp in place and drill a 3/32" pilot hole into the fin through each hole in the clamp, then check the holes from the back through the access hole (as pictured at right) – there needs to be enough room above the top hole and below the bottom hole to fit the head of the bolt in place.

Make any vertical adjustments that may be required then drill to 3/16". Test fit the cable clamp: feed the bolts from the inside and through the side of the fin, then place the angled cable clamp packer against the side of the fin with the wider part of the packer to the rear of the aircraft, then the cable clamp shim and finally the cable clamp. Secure temporarily with plain nuts – final assembly will require Nyloc nuts.

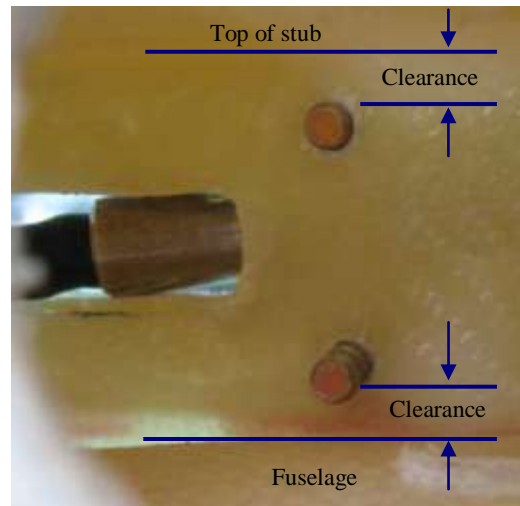

Test the movement of the rudder and rudder cable: make sure that the rudder can be moved to each stop by use of the cable without any binding.

Remove the rudder cable fittings and the rudder and set aside for painting, put all hinge pins, hinge pin retainers and rudder cable fittings into a labelled container for reassembly after painting has been completed.

This completes the *Pre-Paint > Fuselage > Empennage > Fit rudder* task.

Pre-Paint>Fuselage>Fit cowling

Objectives of this task:

To fit the top and bottom cowl to the fuselage. This is a big task that will require time and patience: the cowl will need several test fittings and small adjustments to get the fit just right: take your time and your reward will be a perfectly fitting, great-looking cowl.

Materials required:

Card # J13 'Cowl components' and the piano hinges pack (pictured below)

Epoxy resin and flock

5-Minute Araldite



Match the cowl joins and cut the propeller shaft hole



Start by standing the top and bottom cowls on their bases, align the front of each section carefully and then tape both sections together using cloth tape (circled above).

Look along the side joins and check the alignment: the top and bottom sections should butt up to each other with no gaps as shown at above left. Sand away any areas that overlap until each join is straight and true. Mark the centre front of the propeller boss area then mark a 105mm circle and use a jigsaw to cut the hole out. In the factory we use a circular jig as shown in the second photo but the hole can easily be scribed with a compass. Sand any rough edges.

Fit the top cowl to the fuselage



In this step we will need to make up a spacing jig (shown at left) that will keep the front of the top cowl 20mm behind the propeller flange and 15mm above and centred on the propeller shaft extension, plus a 3mm spacer on top of each ram air duct. Wooden blocks cut to size are fine for the purpose. Tape the jig into place and test fit the top cowl.

Once the front of the top cowl is correctly positioned and centred on the propeller shaft extension, move to the back of the cowl and ensure that it is centred side-to-side: mark the fuselage waterline on each side of the fuselage (photo at right) and measure up to the cowl from that line then move the cowl side to side until the distance is equal on both sides. Recheck that the front of the cowl is still centred. When the cowl is centred at the front and back, mark the centreline on the cowl and on the fuselage in front of the windscreen and then tape the cowl to the fuselage.

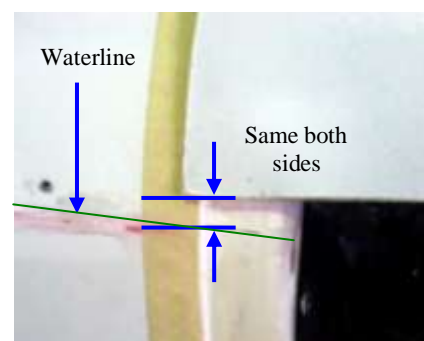

Mark and cut the cowls to length

In the next 2 steps we will need to cut both cowls to length so that they will fit into the joggle.

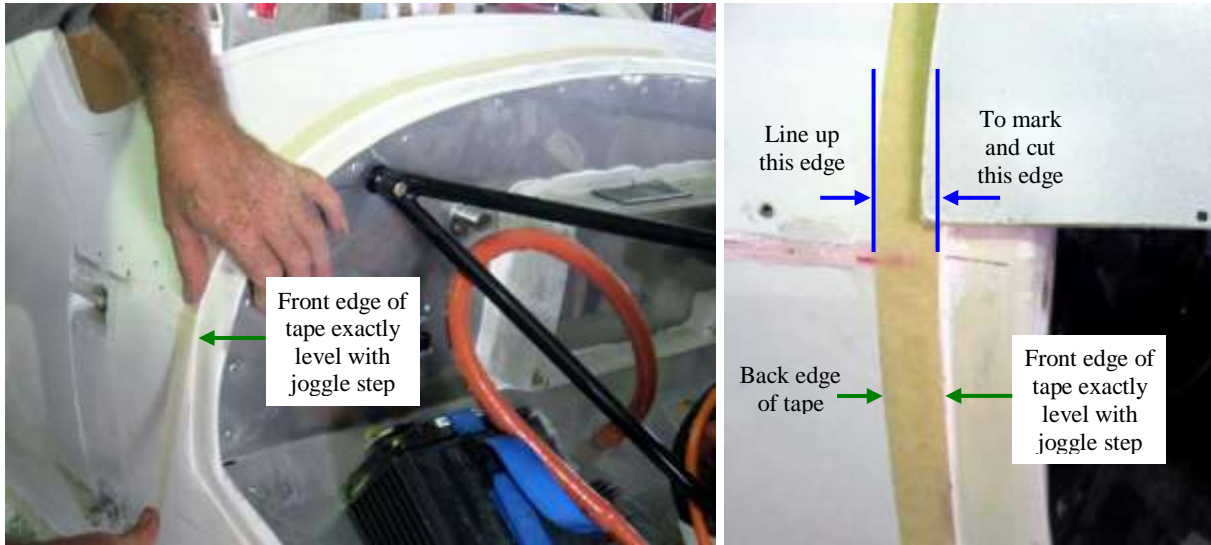

In the factory we have a handy technique that we use to mark the cut: we run masking tape all the way around the outside of the joggle on the fuselage with the front edge of the tape exactly level with the step of the joggle (left photo above) and then when the cowl is in place we run another strip of masking tape around the cowl but with back edge of the cowl tape in line with the back edge of the fuselage tape (left photo below), so we use the width of the tape as a way to accurately mark where to cut. 3/4" masking tape is ideal for the purpose.



In the photo above left the back edge of the cowl tape is being aligned with the back edge of the fuselage tape, while in the photo above right the cut is being made in line with the front edge of the cowl tape. Sand any rough edges away with a long sanding block and refit the top cowl, using the centreline mark to position the cowl at the back and checking that the front of the cowl is still centred, then tape the top cowl into place.

The same “masking tape” technique will be used to cut the bottom cowl to length.

Drill 3 x 3/32" holes through the top cowl and into the fuselage: each hole should be 10mm in from the edge of the cowl, with 1 on the cowl centreline and 1 each side 30mm up from the cowl join. Temporarily fix the top cowl into place with 6G stainless steel screws.

Now that the top cowl has been positioned we can fit the bottom cowl to match it.

Fit the bottom cowl to the fuselage

Offer the bottom cowl up to the top cowl – a well padded saw stool can be used to hold the cowl up – and fit the locating section at the front of both cowls to position the bottom cowl.

Butt the joins together and tape the bottom cowl to the top cowl.

Using the same technique that you used on the top cowl, use masking tape to mark the cowl to the correct length then remove the bottom cowl and cut along the front of the masking tape. Sand all cut surfaces with a long sanding block.

Refit the bottom cowl and tape into place, then mark and drill 5 x 3/32" holes on each side, each 10mm in from the edge of the cowling and each at 60mm away from each bend plus one screw near the bottom of the cowl – the lines in the photo above show the positions.

Temporarily fix the bottom cowling to the fuselage with 6G stainless steel screws.



Trim and finish the ram air ducts



Remove the top cowl and mark the front of the ram air ducts 10mm back from the inside of the bottom cowl as shown above left.

Remove the ram air ducts and trim to the mark, sanding away all rough edges.

Mix up a small batch of 5-minute Araldite and flock and bond the rubber sealing strips around the front of each ram air duct as shown above right, holding the strips in place at 12mm in front of the ram air duct with spring clips while the flock dries.

Remove the bottom cowl and take both cowls to a cleared workbench.

Pre-fit the cowl hinges

You will need some Clecoes for this step. The objective is to position and pre-fit the hinges using the Clecoes and then flock and rivet the hinges permanently into place.

Lay both hinge pairs side by side on the bench. The hinge with the first loop at the very end will be the bottom hinge. Mark the “Top” and “Bottom” part of each hinge pair and then mark each pair “Left” or “Right”. Mark and drill 3/32” holes along the centre of each hinge starting at 10mm in from the end and then at 100mm centres.

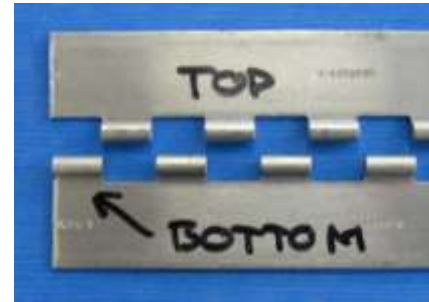

Assemble each hinge pair by sliding the long hinge pin through the full length of the hinge. Note that the hinge pin is much longer than the hinge – do **not** trim the hinge pin to length! The extra length will be used when the hinge pin is fitted through from the door jamb and into the hinge later in this task. Put a cloth tape flag on the exposed end of the hinge pin to prevent possible accidents.



Fit both cowls together, fitting the locating section at the front of both cowls first and then butt the side joins together. Tape the cowls together with cloth tape on both the inside and outside of the joins. Now roll the cowl so that one side join is on the bottom and place the appropriate hinge assembly 30mm in from the back edge of the cowl – shorten the hinge if required. Take care that the hinge is placed so that the hinge pin is exactly in line with the join and with the side of the hinge marked “Bottom” in the bottom cowl.

Hold the hinge firmly in place and drill a single 3/32” hole through the cowl at the back end of the bottom hinge and fix the hinge in place with a Clecoe.

Now align the front of the bottom hinge, drill and Clecoe into place. Repeat the process on the top hinge then drill and Clecoe every other hole. Drill the remaining holes through the cowl.

Roll the cowl around to the other join and repeat the entire process for the other hinge.

At this stage the hinges hold both cowls together as shown at right, with Clecoes fixing the hinges to the cowls.

Mark each hinge and the cowl half that it belongs to and then remove the Clecoes and the hinge pins.



Fix the cowl hinges

Sand the bonding surface on each cowl half and the backs of each hinge half to give the flock a good key to bond to. Clean your Clecoes in Acetone and dry them. Keep the tin of Acetone handy for later (in fact storing your Clecoes in Acetone can be a good idea because it keeps them free of oil and other contaminants that could affect an efficient bond).

Mix a batch of resin and coat the bonding surface of each cowl then add some flock to the remaining resin and then, working on one half of one hinge at a time, apply an even layer of flock approximately 2mm thick to the hinge and fix the hinge in place with clean Clecoes in every other hole and then rivet the remaining holes before removing the Clecoes.

Working on one hole at a time, drill a 3/32" hole and use a 120° countersink bit to carefully countersink the outside of each rivet hole just enough to allow a countersunk rivet to sit slightly below the surface of the cowl (example circled at right) then rivet each hole before moving on to the next hole.

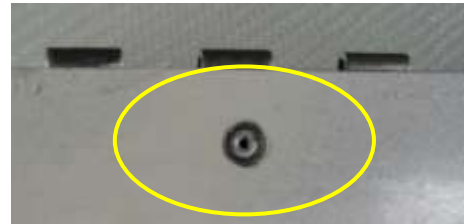

Drop each Clecoe in the Acetone as you remove it to clean the flock out of it. Clean away as much flock as possible from around the hinge pin holes, smooth the flock along the other side of the hinge with a mixing stick and leave the flock to cure overnight.

Next day test fit the hinge pins and remove any remaining flock from the hinges.



In the factory we use a special drill bit (shown above) that is just a standard drill bit welded onto the end of a spare hinge pin and we clean the hinges through with that (top photo), using a low drilling speed to prevent any whipping of the long bit. It is important that the hinge pins fit easily into the hinges without any restrictions.

Fit the hinge pin guides

These guides are the 2 lengths of aluminium tube on the Card that are used to guide the hinge pins through the door jambs and into the cowl hinges. When the cowls are finally installed the ends of the hinge pins will be bent in at right angles and the door will hold them in place.



Refit the bottom cowl to the fuselage and hold the hinge in against the joggle then mark a line beside the firewall and directly behind the hinge. Drop the cowl and drill a 1/4" hole at this point as shown above left: it will be just inside of the fuselage skin.

Mark a point on the front of the door jamb 10mm in and in line with the cowl join as shown above right, which will be very near to the waterline, and drill a 1/4" hole towards the hole that you have just drilled. Use a file to round the ends of the guide tubes slightly.

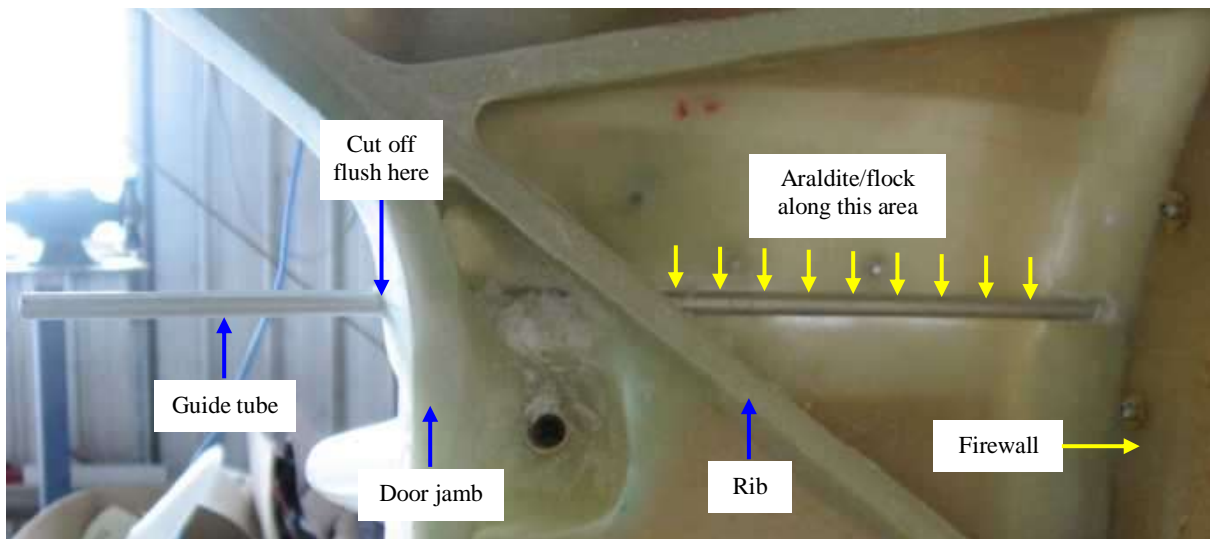

Continue to drill through the rib until the guide tube can be pushed all the way from the door jamb and through the firewall.

Allow the guide tube to protrude very slightly, about 1/4" as shown circled at right.

Check that the hinge pin will line up with the bottom cowl in place and then fix the guide tubes in place with 5-minute Araldite and flock.

Hint: a strip of masking tape under the tube acts as a dam to keep the Araldite/flock mix in place while it cures. Once the Araldite/flock mix has cured use a hacksaw to cut the tube off flush with the door jamb.

Clean any burrs and flock out of the guide tube.

Repeat the process for the other side of the fuselage.



Final fit the cowling

Fit the top and bottom cowls to the fuselage and insert the hinge pins from the front door openings. Drill one 5/16" hole through each side of the propeller boss for a Camloc fitting (shown circled at right).



Starting with the bottom cowl, remove one 6G stainless steel screw at a time and drill the hole out to 3/16", then drill the 3 holes in the top cowl to 5/16".

Remove the cowls and fit the captive nuts (a complete captive nut assembly shown at right) to the 3/16" holes in the bottom of the fuselage.



Use the captive nut itself as a jig to drill the rivet holes as shown at above right – thread the screw part way through the captive nut from the back and fit the exposed end of the thread into the hole in the fuselage, then drill the 2 x 3/32" rivet holes.

Repeat this process for each captive nut and then fit the captive nuts to the inside of the fuselage, countersinking each rivet hole and riveting from the outside of the fuselage.

Use a similar technique for the 5 Camloc fasteners in the top cowl (3 at the back, 2 around the propeller boss): hold the captive part of the Camloc centred over the hole and drill the 3/32" rivet holes then fit the captive part inside the fuselage, once again countersinking the rivet holes on the outside of the fuselage. A complete Camloc assembly is shown at right:



Countersink the holes in the bottom cowl enough to allow the Tinneman washers to seat snugly. Do not countersink the holes in the top cowl, just deburr them.

Fit the machined oil door

Locate the marked position on the right side of the top cowl. Lay the oil door on the marking and mark around it, then move the oil door forward 2mm and remark the front – this slightly larger gap (circled at right) is to allow for the forward movement of the hinge when the oil door is opened.



Assemble the door to the hinge and fit to the hinge surround. Sand around the inside of the oil door opening and then test fit the door assembly, taking care to keep the door centred sideways and to the rear of the opening with the hinge to the front. Tape the door to the cowl with 2 strips of cloth tape to keep the correct position.



Mix a batch of 5-minute Araldite and flock, then lift the hinge frame up, apply the Araldite/flock mix to the hinge frame and seat the hinge frame to the cowl. Take particular care that no Araldite/flock gets into any part of the hinge.

Fit the cabin air inlet flange

Drill a 30mm hole on the left front of the lower cowl, 100mm below the bottom lip of the air inlet and 180mm to the left of the propeller centreline.

Sand the back of the flange (from Card # J25) and around the inside of the cowl around the hole.

Mix a small batch of 5-minute Araldite and flock and fix the flange into place.

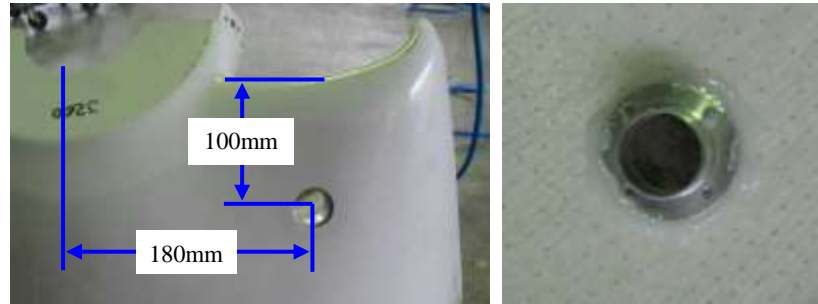

Fit the induction air (NACA) duct

The induction air duct is fitted to the left hand side of the bottom cowl.

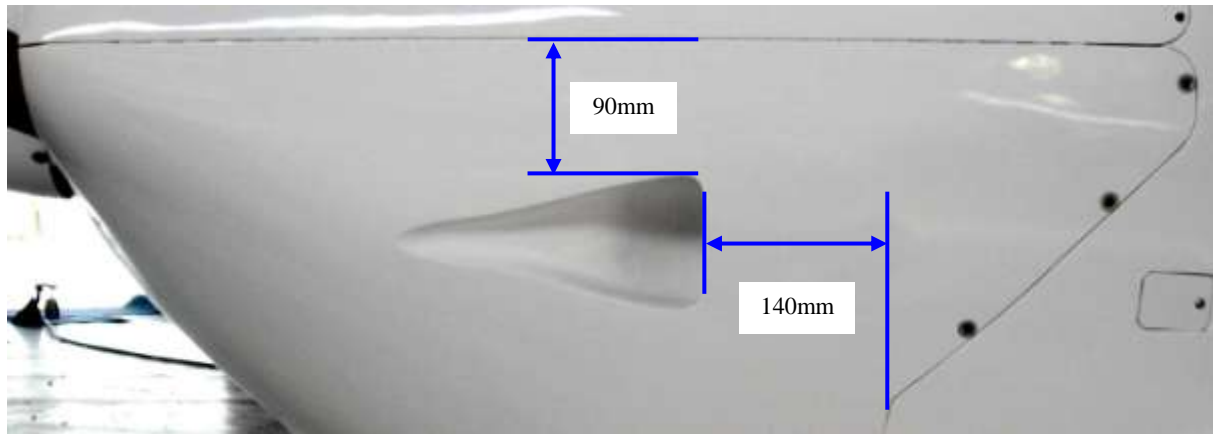

Assemble the duct with 5-minute Araldite. Hold the scoop on the outside of the cowl in the position as shown above, keeping the rear edge of the scoop at right angles to the hinge line and mark around the outside of the unit and then make a second line inside the first about the size of the actual opening.

Cut the opening and fit the scoop to the inside of the cowl, holding it in place with 5 x 6G stainless steel screws and adjust the opening to match the shape of the scoop. Mix a batch of 5-minute Araldite and flock and fix the scoop into place, holding it in place with the screws.



When the Araldite/flock has cured, heat and remove the screws, mix a small batch of resin and apply a single layer of AF303 glass fibre cloth on the inside of the cowl over both sides and across the rear of the scoop. Leave overnight to cure.

Next day apply filler to blend the cowl opening smoothly into the scoop.

Do a final test fit then remove and store the cowls and hinge pins until you are ready to paint.

This completes the *Pre-Paint > Fuselage > Fit cowling* task.



Pre-Paint>Fuselage>Fit flap drive shaft bearing blocks

Objectives of this task:

In this task you will position and flock the flap drive shaft bearing blocks to the inside of the fuselage.

Note that the flap drive shaft will be fitted in the *Post-Paint* section: only the bearing blocks will be fitted in this task.

Materials required:

Card # 16 'Flaps'

Resin and flock

Prepare the drive shaft



The flap drive shaft is only used for bearing block alignment at this stage, so you will need to remove all the fittings: one drive arm from each end and the lever arm from one end, until you have just the bare tube. Note that there are actually 2 tubes, one inside the other: make sure that both tubes are still together when this task is completed and the shaft is reassembled.

Position the bearing blocks

Place the drive shaft through the pre-drilled $\frac{3}{4}$ " holes (circled) so that the shaft protrudes an equal amount from each side of the fuselage, then slip one bearing block on each end with the screw holes to the top.

Level the top of the block, hold it firmly in place and drill 2 x $\frac{3}{16}$ " holes through the fuselage skin, using the bearing block as a drilling jig as shown below right:

Mark the blocks to indicate which side of the aircraft they fit to as well as an arrow towards the front of the aircraft, then remove the flap drive shaft and the bearing blocks. Wax each end of the shaft – it will be used to align the bearing blocks as you flock them into place and the wax will prevent any flock sticking to it.

Countersink the outside of the screw holes to suit the Tinneman washers.

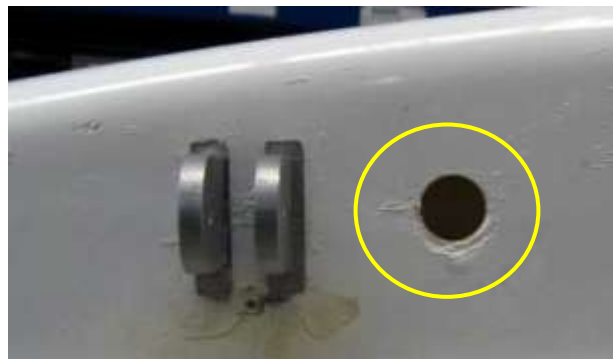

Fit the bearing blocks

Roughen the inside of the fuselage around the area where the bearing blocks will be mounted and sand the backs of the bearing blocks, mix a small batch of resin and coat the area to be bonded then add flock to the resin and apply a 3mm bed of flock to the back of each block, then slip them onto the shaft with the flocked sides facing out and fit the shaft to the fuselage one end at a time, working from inside the cabin.



Move each block out and bed it against the fuselage and secure it with countersunk screws and Tinneman washers from the outside of the fuselage and washers and Nyloc nuts on the inside. The photo above shows the bearing blocks (circled) flocked into place with the drive shaft keeping them in alignment: the photo has been taken from the front of the aircraft facing towards the rear.

Tighten the nuts just enough to hold each block in place while leaving the shaft free to turn. Clean away any excess flock from around the block and leave overnight to cure. The photo at right shows the fitted block from the outside with the drive shaft still in place, while the photo below shows the block from the inside with the shaft removed.



Next day tighten the Nyloc nuts firmly and do a final check for binding, then remove the flap drive shaft completely: pull it out through one side of the fuselage, clean off the wax, make sure that the inner and outer shafts are fitted together then reassemble the drive fittings to the shaft and store for later use.

This completes the *Pre-Paint>Fuselage>Fit flap drive shaft bearing blocks* task.

Pre-Paint>Fuselage>Interior>Console>Pre-fit handbrake

Objectives of this task:

To pre-fit the handbrake master cylinder and lever to the centre console. At the completion of this task the handbrake will be removed and stored until final fitting following painting and installation of the interior trim.

Completed handbrake master cylinder, handbrake lever and locking cam, as viewed from the right-hand side ►

Materials required:

Card # J8 'Brakes'

Loctite 577

Fit the master cylinder

Using a small bead of Loctite 577 on the thread, attach the brass compression fitting to the master cylinder and tighten firmly. Put a piece of masking tape over the hole to keep foreign objects out.

Drill the upper and lower mounting holes out to 5/16" (arrowed below), then, working through the side access holes in the console, fit the brake lever mount into the front of the console (refer to drawing 6A027A0D-3 on the next page for detail) using two hex head bolts in the top and bottom holes, then mount the master cylinder to the brake lever mount with the cap screws– the photo at right shows the orientation of the components: note that the brake lever mount has the pivot hole to the top.

The photos below show the fitting of the brake lever mount and the master cylinder to the console.

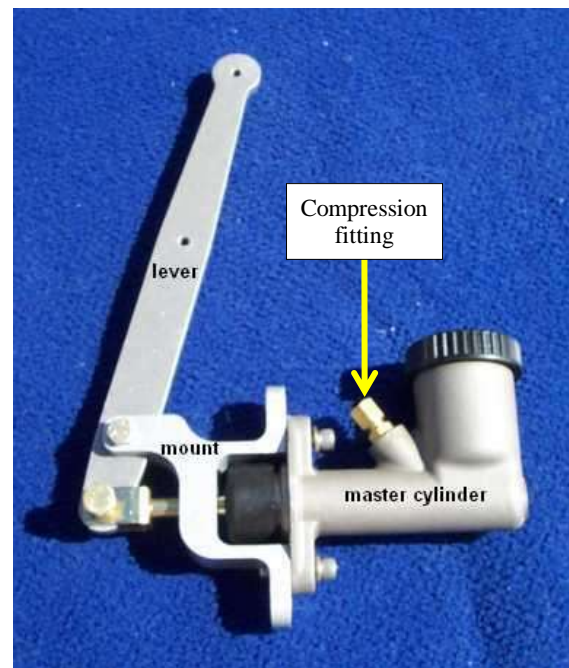

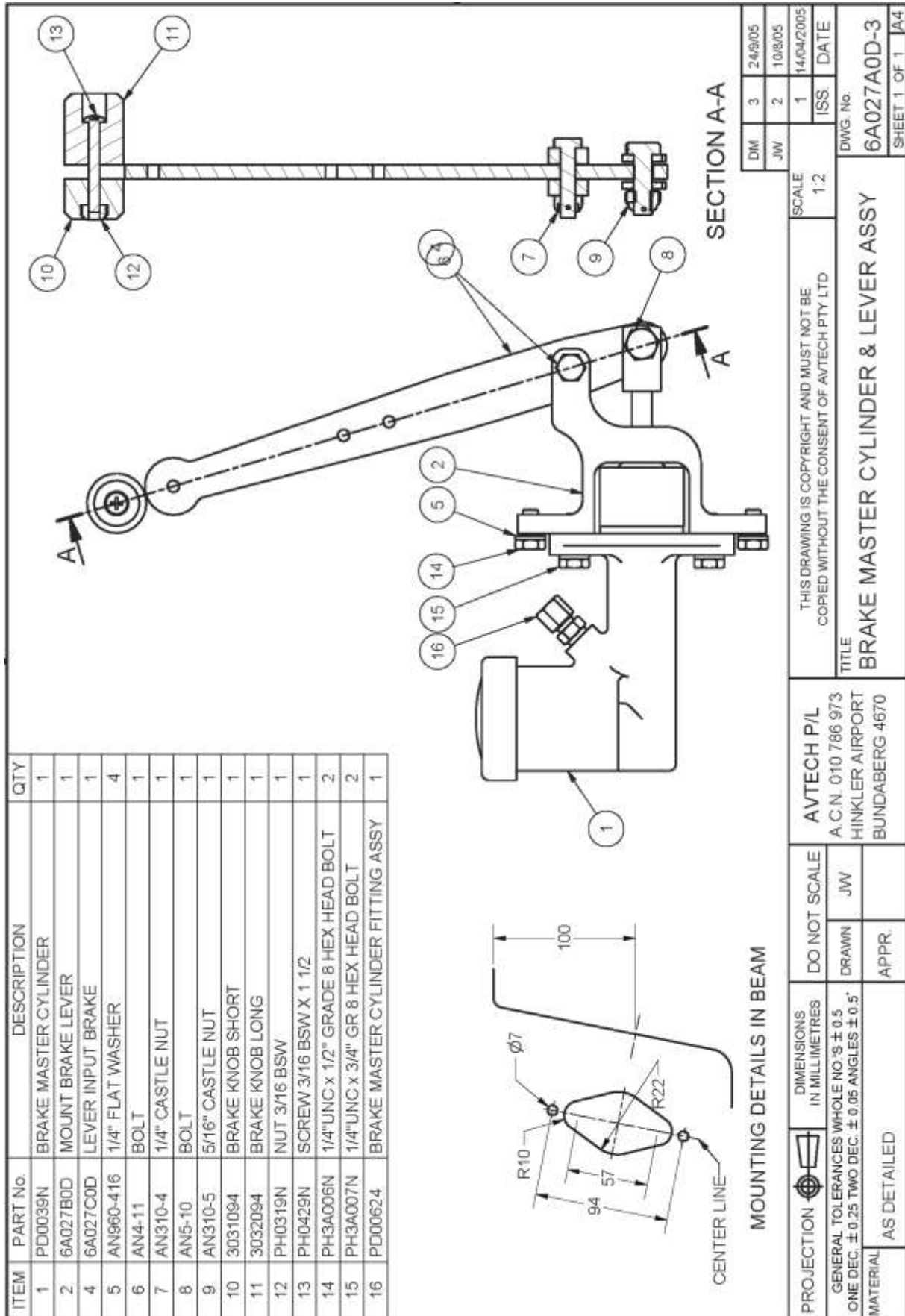



Fit the handbrake lever

Assemble the two red knobs to the handbrake lever, with the longer knob to the left of the lever (the same side as the machined recess) and secure with the supplied bolt and nut.

Fit the handbrake lever cam to the right-hand side of the handbrake lever with the supplied bolt and Nyloc nut and with a ¼" Bundy tube bush in place to allow free movement of the handbrake lever locking cam.

The lever assembly can now be fitted to the brake lever mount. It may be necessary to file the cut-out on top of the console in order to achieve full fore and aft travel of the handbrake lever as well as the correct side clearance for the handbrake lever locking cam.

Check that the handbrake lever has full movement and that the handbrake lever locking cam does not bind against the sides of the console cutout, then remove the entire handbrake assembly and put aside until the *Paint* and *Interior Trim* tasks have been completed.

This completes the *Pre-Paint>Fuselage>Interior>Console>Pre-fit handbrake* task.

Pre-Paint>Fuselage>Interior>Console>Pre-fit trim control

Objectives of this task:

To pre-fit the trim pivot assembly, trim stops and the dual trim levers to the centre console and fit the trim cable clamp to the seat base. At the completion of this task the trim levers will be removed and put aside until the final fitting following painting and installation of the upholstery.

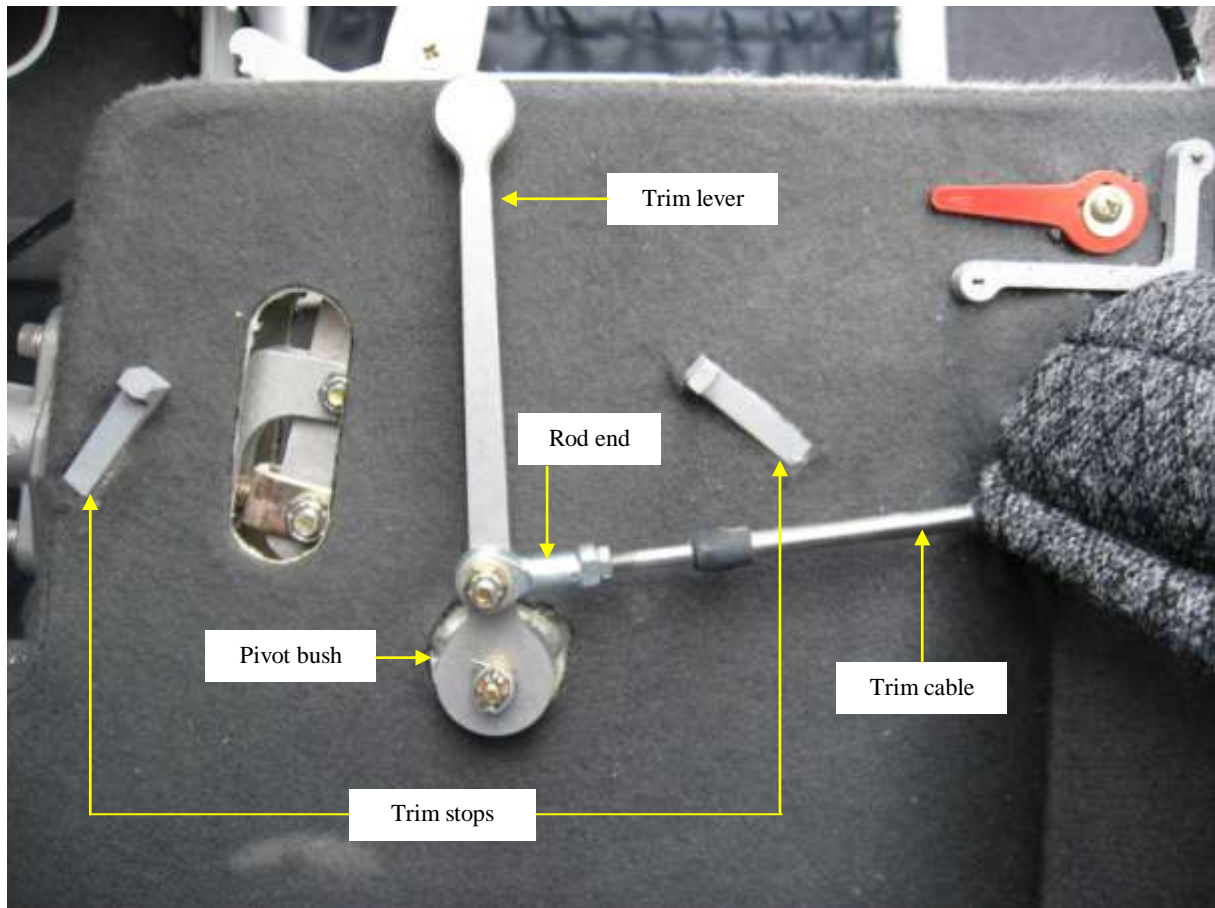

This task is broken down into three items, which should be done the following order:

1. Align & fit the trim pivot bushes
2. Align & fit the trim stops
3. Align & fit the trim cable clamp

Materials required:

Card # J2 'Trim System'

Epoxy Resin and Flock

5 minute Araldite

260 x 160mm 3-ply for template

Trim pivot and trim levers:

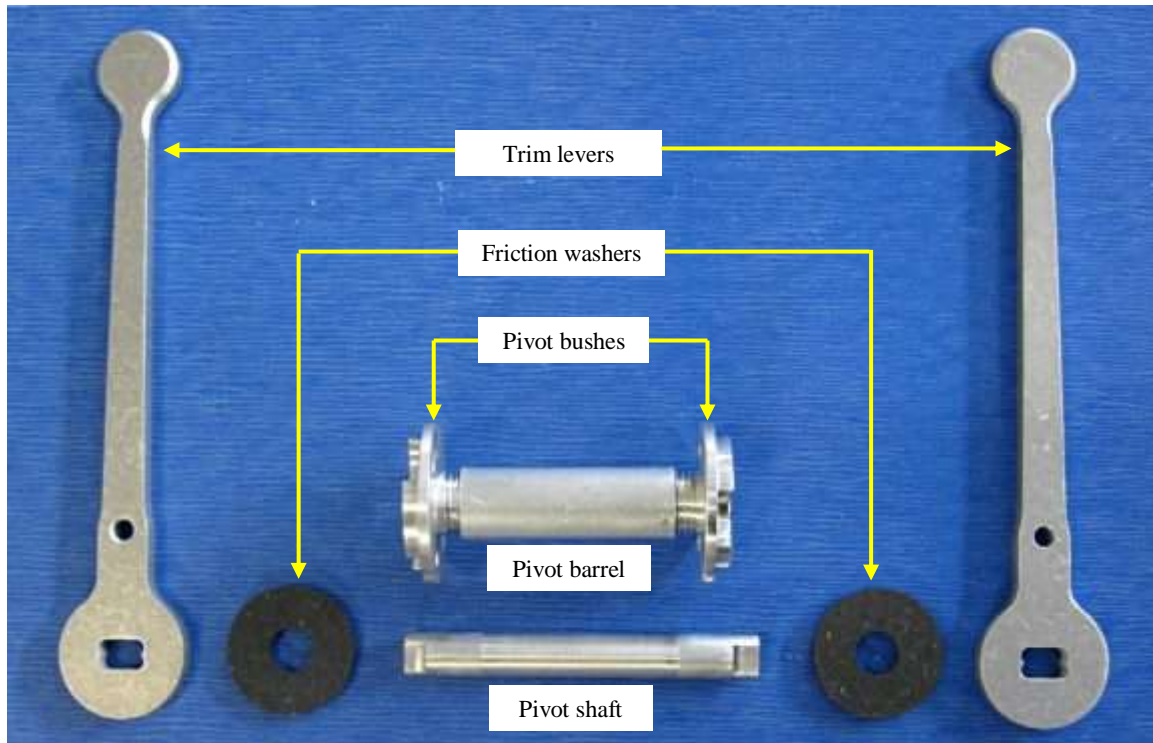

Align and fit the trim pivot bushes

Pilot holes for the *pivot bushes* are pre-drilled in the console. Start by enlarging the holes for the *pivot bushes* slightly with a round file until the *pivot bushes* can be fitted snugly and the file sits level through the holes and square to the console when viewed from above.



Screw the left-hand *pivot bush* firmly into the *pivot barrel*.

Push the pivot barrel through the console and flock into place then loosely fit the right-hand side pivot bush. Line up the left-hand side rivet holes and secure the left-hand side *pivot bush* with three TLR rivets as shown at left.

Push the *pivot shaft* through the *pivot bushes* and temporarily fit the *trim levers*, including the *friction washers*, and tighten the castellated nut onto the pivot bolt by hand until the *trim levers* are held securely onto the *pivot shaft*.

Move the *trim levers* fore and aft: both *trim levers* should maintain an even distance out from the console. If this is not the case the hole for the right-hand *pivot bush* may need to be elongated slightly to correct the alignment. Note that if the right-hand hole has been elongated you will need to rotate the right-hand *pivot bush* 1/6 of a turn and drill three new rivet holes for that side only.

Once the *trim levers* can move freely fore and aft while maintaining an even distance out from the console, flock and tighten the right-hand *pivot bush* firmly into place and secure with three TLR rivets, fitted one at a time and rechecking the *trim levers* alignment after each rivet has been placed.

Smooth any surplus flock with a small amount of resin on a clean mixing stick.

Align and fit the trim stops

Make the template from a piece of 3-ply plywood as shown below and position the hole at the bottom of the template on the *pivot shaft* and the top level with the top of the forward console.

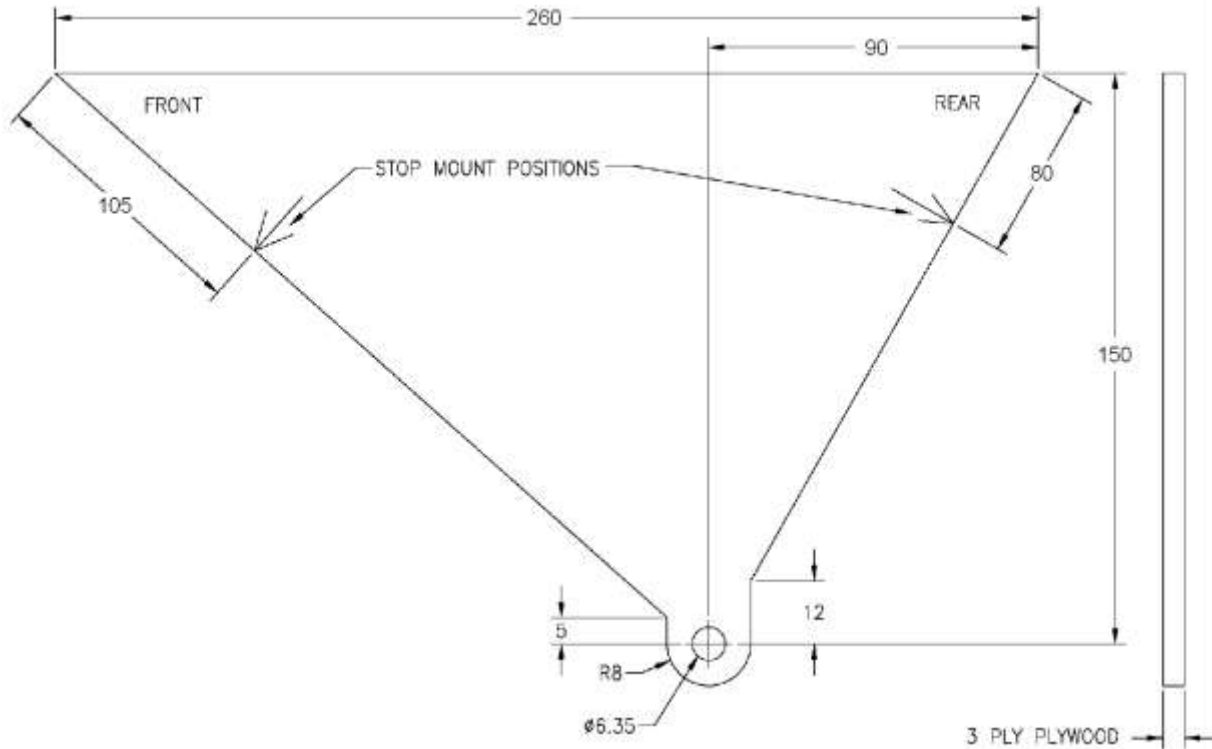

Mark the locations for the *trim lever stops* on the left hand side of the console only and lightly sand the areas underneath to ensure a solid joint. Using 5 minute Araldite and flock, fit the *trim lever stops* in position, temporarily secure each with a self-tapping screw and leave to cure, then remove the screws and fill the holes.

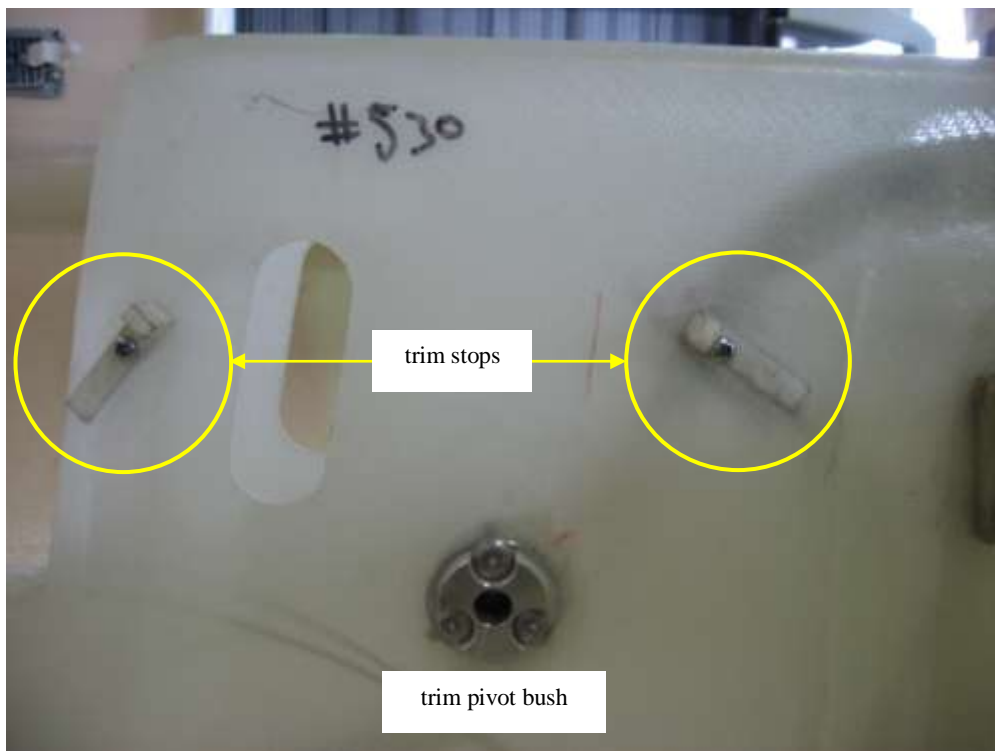

Align and fit the trim cable clamp

It is important that the *trim cable clamp* is accurately positioned against the left-hand side of the console in a way that minimises any bending loads on the *trim cable*. The procedure is as follows: with the *trim cable* in place and working from the left-hand side of the console, put a *rod end* fully onto the cable end: thread the *rod end* all the way onto the cable end, then bolt the *rod end* to the left-hand *trim lever* as shown in the first photo below.

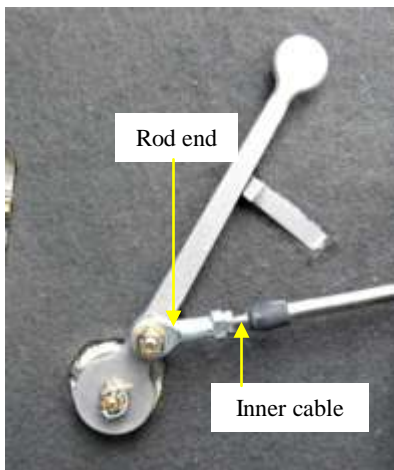

Push the *inner trim cable* all the way into the *outer cable* then put the *trim lever* against the rear *trim stop* as shown at left. This is the correct position for the *outer cable* to be secured by the *cable clamp*. Fit the *cable clamp* to the *outer cable* and make sure that the *cable clamp* grips the *locating groove* on the outer cable (circled at right).



Position the *trim cable clamp* against the console in such a way as to line the *trim cable* up with the *rod end* on the *trim lever* and drill 2 x 3/16 holes through the *cable clamp packer* and into the side of the console as shown in the photo shown below at right. Temporarily position with 2 x AN3 bolts.

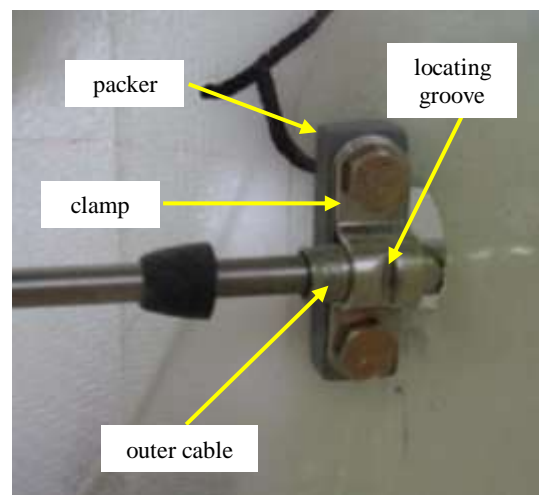
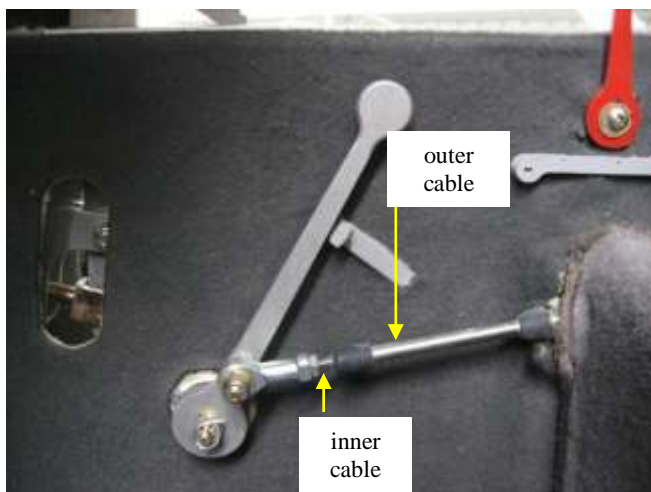

Bond the *cable clamp packer* into place and leave to cure. Remove the aligning bolts. Fit the *cable clamp shim*, the *trim cable* and the *cable clamp* and mount with 2 x AN3 bolts placed from the inside of the console and secured with Nyloc nuts on the outside of the *cable clamp*.

Remove the *trim levers*, *pivot bolt* and *pivot shaft* and put aside for later fitting after painting and upholstery have been completed.

This completes the *Pre-Paint > Fuselage > Interior > Pre-fit trim control* task.

Pre-Paint>Fuselage>Interior>Console>Fit control stick

Objectives of this task:

In this task you will fit the elevator cable to the console and then align and fit the two control column bushes into the console, set up the endplay of the control column and fit the control stick to the console.

Materials required:

Card # J17A 'Elevator System and Control Stick'

Epoxy Resin and Flock

Fit the elevator cable clamp

The elevator cable runs through the console and through to the rear of the fuselage inside the longitudinal rib.

Drill the existing 3/16" holes through and place both bolts through the mounting holes from the inside of the console, through the cable clamp backing plate and then through the saddle clamp.



Take care to align the locating groove in the outer cable with the matching point on the saddle clamp, then secure with Nyloc nuts and mark the nuts with *TorqueSeal*.

Press fit the rear bush

The metal rear bush must first be pressed into the mounting plate - a bench vise is the most convenient way to do this as shown in the picture at the right.

Note that the flange on the rear bush goes on the outside face of the mounting plate.

The two photos below show the rear bush fully pressed into the mounting plate.





ITEM	PART NUMBER	DESCRIPTION	QTY
1	1007094-4	BUSH - CONTROL COLUMN	1
2	3A08180D-1	CENTRE STICK PIVOT SHAFT	1
3	3A02660D-5	DOUBLE CENTRE STICK PIVOT PLATE	1
4	3117094-2	POLYURETHANE WASHER 10mm ID, 25.4mm OD, 1 THICK (NOT DRAWN)	2
5	3000C84-5	SPACER CENTRAL PIVOT	4
6	AN860-10	3/16" FLAT WASHER	9
7	MS20365-1032	3/16" NYLOC NUT	5
8	AN3-13A	3/16" BOLT	3
9	AN3-21A	3/16" BOLT	1
10	AN3-16A	3/16" BOLT	1
11	AN860-416	1/4" FLAT WASHER	1
12	P800194	3/16" FEMALE ROD END	1
13	PM0055N	END CAP	2
14	PM0038N-cut	RUBBER HAND GRIP	2
15	3A026F0D-6	DOUBLE CENTRE STICK HANDLE ASSY	1
18	P10062N-1	P/T SWITCH (SPST MOMENTARY ON, 3A, 125V/1A, 250V)	2
19	3A087D0D-2	AILERON BELLCRANK INBUILT STOPS	1
20	3A087A0D-1	ASSY - CONTROL SHAFT END HIGH AIL STOPS, SKF BEARING	1
21	MS36207-267	SCREW 10-32 X 3/4	2
22	AN316-3	3/16" NUT	2

DB 4	49007	SCALE	1	ISS. DATE	1	25/05/08
DB 3	13/4/07	NTS				
DB 2	20/11/06					
THIS DRAWING IS COPYRIGHT AND MUST NOT BE COPIED WITHOUT THE CONSENT OF AVTECH P/TY LTD TITLE CONTROL STICK ASSY J160 HIGH AILERON STOP DRAW. No. 3A081A0D-4 SHEET 1 OF 1 A3						

PROJECTION	GENERAL TOLERANCES	DIMENSIONS	DO NOT SCALE	AVTECH P/L
1ST ANGLE	IN MILLIMETRES	AS SHOWN	AS SHOWN	A.C.H. 010 788 873
	±0.25 TYPICAL	±0.05 ANGLES ±0.5°		HINKLER AIRPORT
				BUNDBERG 4670
REFER TO PART DRAWINGS			APPR.	

Fit the bushes to the console

Fit the stick pivot plate carefully into the control shaft and secure with 2 x AN3-13A bolts, spacers, washers and Nyloc nuts. The nuts should face the left-hand side of the aircraft when fitted.

Slip the front nylon bush over the control shaft.

With the rear bush and mounting plate taped in place, fit the control shaft into the console from the front and through the rear bush, seating the front bush.

Mount the aileron bellcrank onto the rear of the control shaft, taking care to keep the bellcrank square to the shaft, and temporarily secure it by easing an AN3 bolt through the bellcrank and the shaft as shown below right.

Do **not** force the bolt through the holes: ensure that the holes are aligned exactly before fitting the bolt.

Now the control shaft is held in the console by both the front and rear bushes. At this point make any adjustments necessary to allow the control shaft to rotate freely in the bushes – you may need to file small amounts out of the console to correct the alignment of the front or rear bushes.

Take your time with this step: you want the **absolute minimum** of turning resistance!

Make sure that the rear mounting plate is pushed fully into the console and then move the front nylon bush out as required to take up any endplay: you require only a **very** small amount of endplay, no more than the thickness of a single sheet of paper.

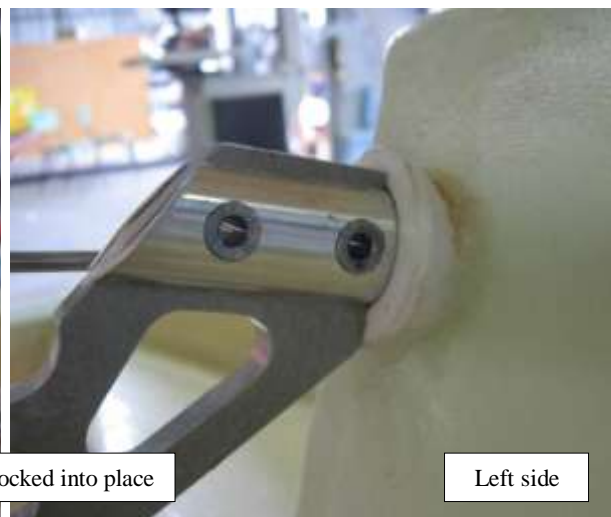
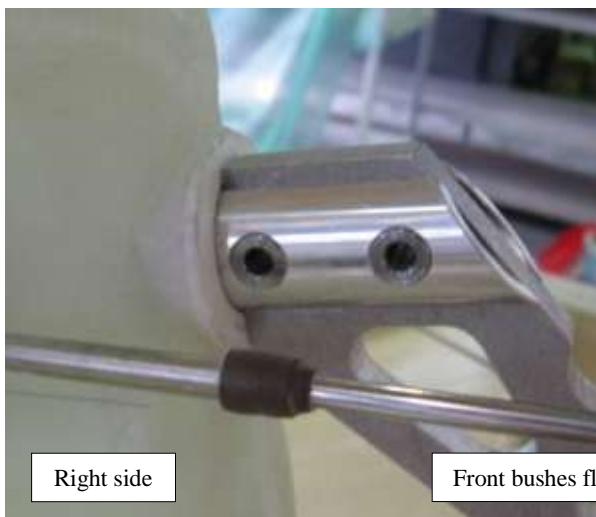
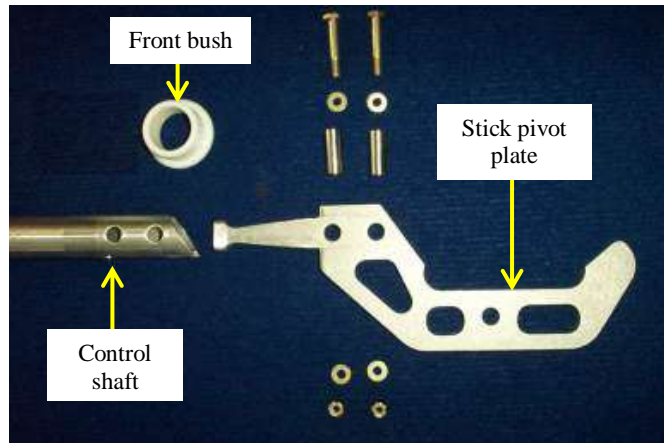

Front bushes flocked into place

It is very important that the rear bush and mounting plate are fitted to the console at precisely 90° to the control shaft, and that there is no friction between the bushes and the shaft.

When you are satisfied with the alignment of both bushes and the endplay is correct, remove the aileron bellcrank and pull the bushes out enough to coat each bush with flock, then push both bushes back into place. Refit the aileron bellcrank and reset the endplay very carefully and leave to cure, taking care not to get any flock onto the control shaft. Smooth off any surplus resin with a small amount of resin on a clean mixing stick.

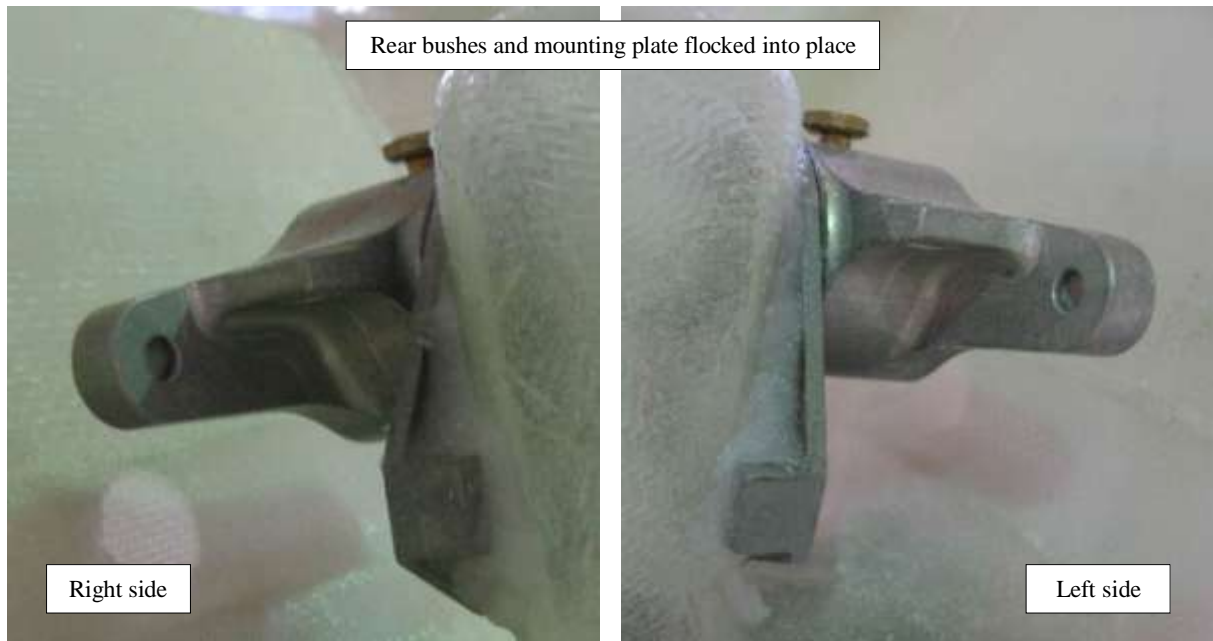

When the flock has cured, remove the temporary bolt from the aileron bellcrank and withdraw the control shaft. Clean any flock from the control shaft and from around the bushes then reinsert the control shaft, check that the control shaft can rotate freely and that the endplay is minimal and then remove the control shaft and the aileron bellcrank and set aside until the fuselage has been painted.

This completes the *Pre-Paint>Fuselage>Interior>Console>Fit control stick* task.

Pre-Paint>Fuselage>Interior>Fit rudder pedal mount blocks**Objectives of this task:**

In this optional task the lower rudder pedal mounting blocks will be checked for vertical alignment and if necessary the lower blocks will be flocked into place on the floor brackets.

This task shows how to ensure that the blocks are aligned correctly.

Materials required:

Rudder pedal mounting blocks (3 pairs)

3 x ¼” and 2 x 3/16” bolts, 3” or longer

Rudder pedals

Epoxy Resin and Flock

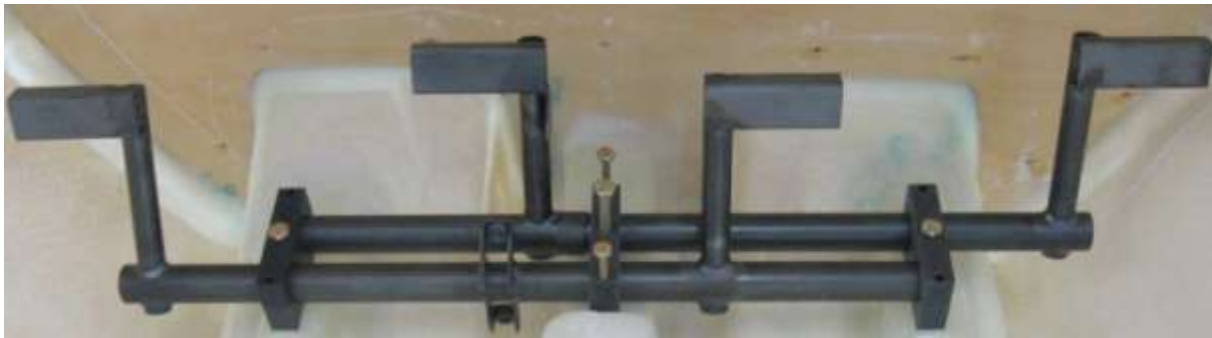
Check the alignment

Fit the rudder pedals into place as shown above, with the mount blocks supporting the pedal assembly. Check each lower block to see if it is touching both the floor mounts and the rudder pedal assembly main bar. If any block can be moved up and down then you should follow this procedure, otherwise skip this task and go to the next task.

Align the Mount Blocks

The key to correct alignment is the use of a bed of flock under each mount block to allow for any unevenness in the height of the three floor mounts – sometimes there may be a slight height difference that, if not corrected, could lead to binding of the rudder pedals.



Position the three mount blocks by placing a centre bolt through the centre hole of each mount block only. Mark a pencil line around each mount block and then remove the mount blocks.

Sand a slightly bigger area than the marked area and sand the bottom of each mount block to ensure a good key for the flock.

Mix a small batch of flock and apply to the marked areas, taking care to keep flock out of the three captive nuts under the centre mount block, then loosely place each mount block into position again with a single bolt in each centre hole. Gently place the rudder pedals shafts into the blocks and apply a slight downward pressure to seat all three mount blocks firmly into the flock.



Now fit the top of the mount blocks: working on one mount block at a time, remove the centre bolt, place the top of the mount block in place and replace the centre bolt. Place all three bolts in the centre mount block and do them up by hand until the bolts reach the bottom of the captive nuts – this will ensure that no flock will get into the threads.

Carefully rotate the rudder pedal shafts by moving the rudder pedals forwards and backwards – there should be no binding whatsoever.

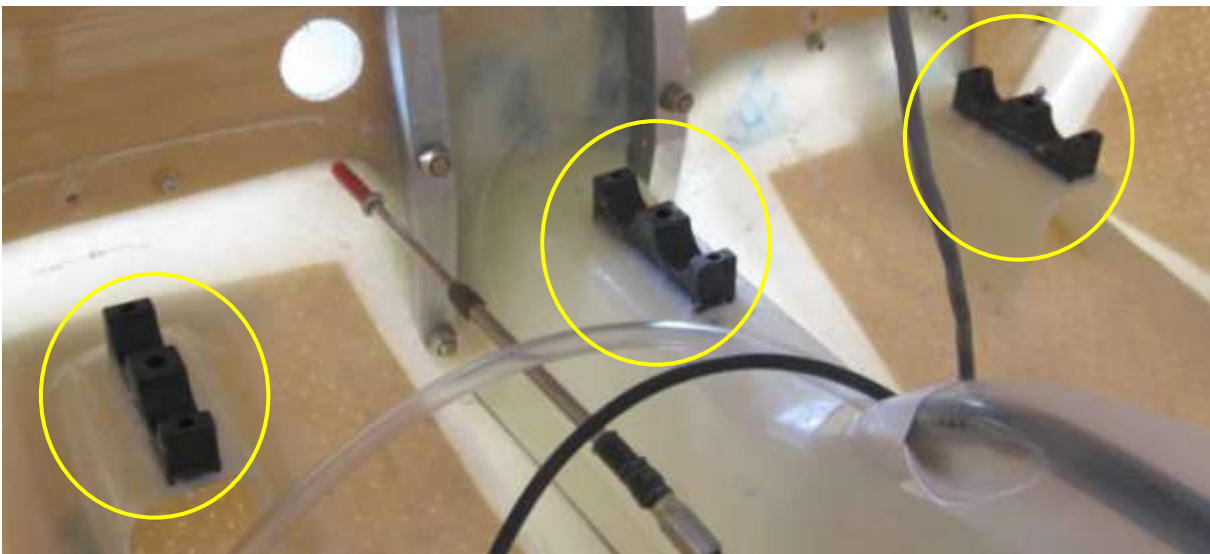

Smooth off any excess flock with a small amount of resin on a clean mixing stick. Leave to cure, taking care that no flock has contacted the rudder pedals. When the flock has gone off and is firm, carefully remove the bolts. Once the flock is completely cured remove the top of each mount block and the rudder pedals and set them aside until after the paint and upholstery tasks have been completed.

Run a drill through the holes in the left and right mount blocks to remove any excess flock.

This completes the *Pre-Paint>Fuselage>Interior>Fit rudder pedal mount blocks* task.

Pre-Paint>Fuselage>Interior>Fit aileron cable brackets

Objectives of this task:

In this task the aileron cable brackets will be positioned and mounted to the seat backs.

Positioning of the aileron cable brackets is absolutely critical and great care must be taken in this task.

Materials required: →

Card # J5 'Aileron System'

Epoxy Resin and Flock

3/16" TLR rivets from the hardware pack

220 x 270mm plywood or heavy cardboard for the alignment template

Position and fix the aileron cable brackets



completed aileron cable mounts as viewed from the rear facing forwards

Preparation

Start by making the positioning template from the drawing on the next page. Heavy cardboard is quite adequate for the template as long as care is taken to cut the lines and drill the holes accurately.

It will be necessary to redrill the top rivet holes in the aileron cable brackets – scribe a line parallel to the top of the bracket and in line with the centre of the existing hole.

Centre-punch and drill 2 new 3/16" holes as shown at right.

Make sure that you leave enough clearance around each hole for a 3/16" washer.

Clean around each hole and test a rivet in each hole – it should be a snug fit.





Aileron cable bracket positioning template

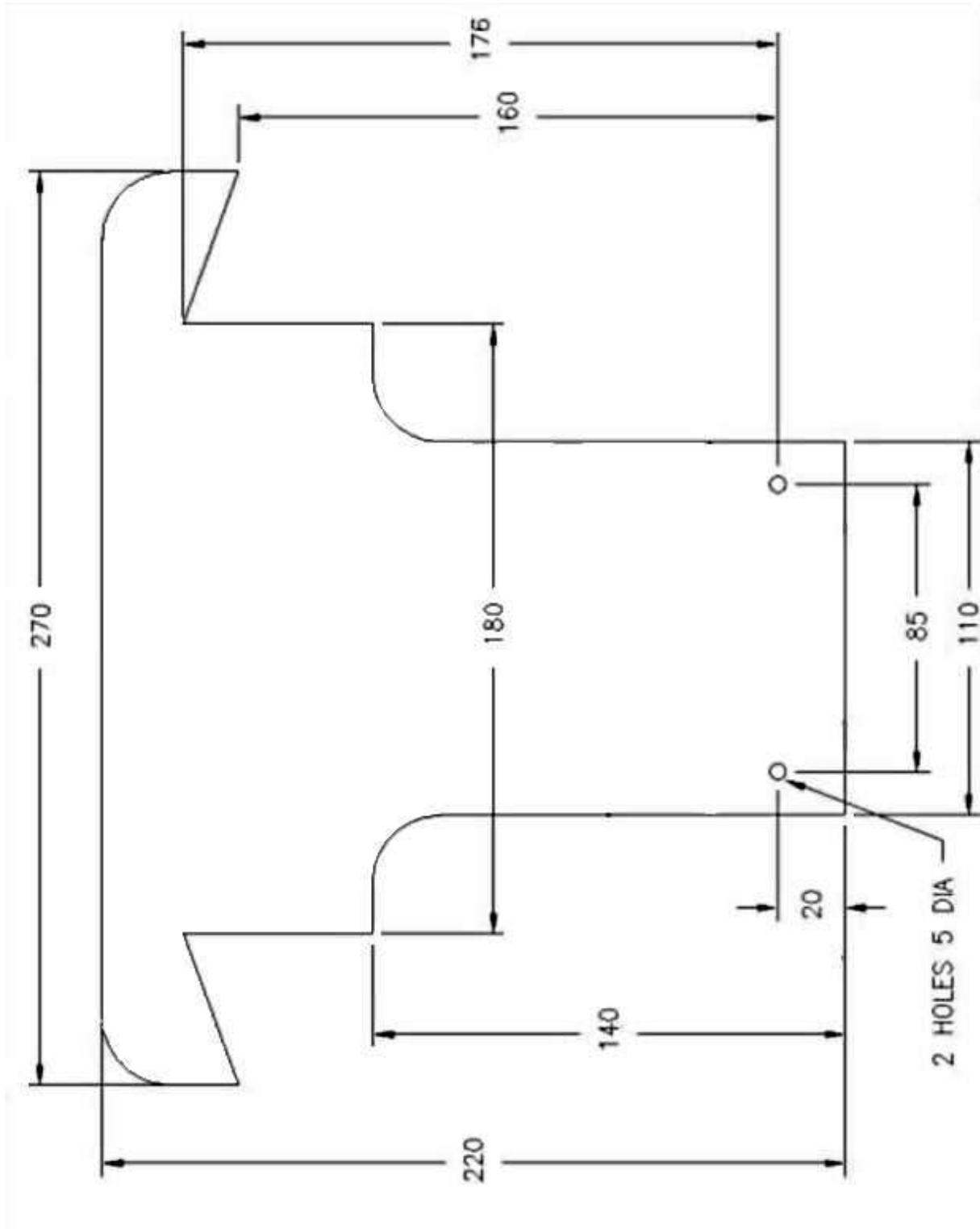

Align the template and mark the bracket positions

Temporarily attach the template to the control yoke with 2 bolts placed through the yoke and into the template as shown circled at the bottom of the photo at right.

Level the top of the template in line with the top of the seat backs.

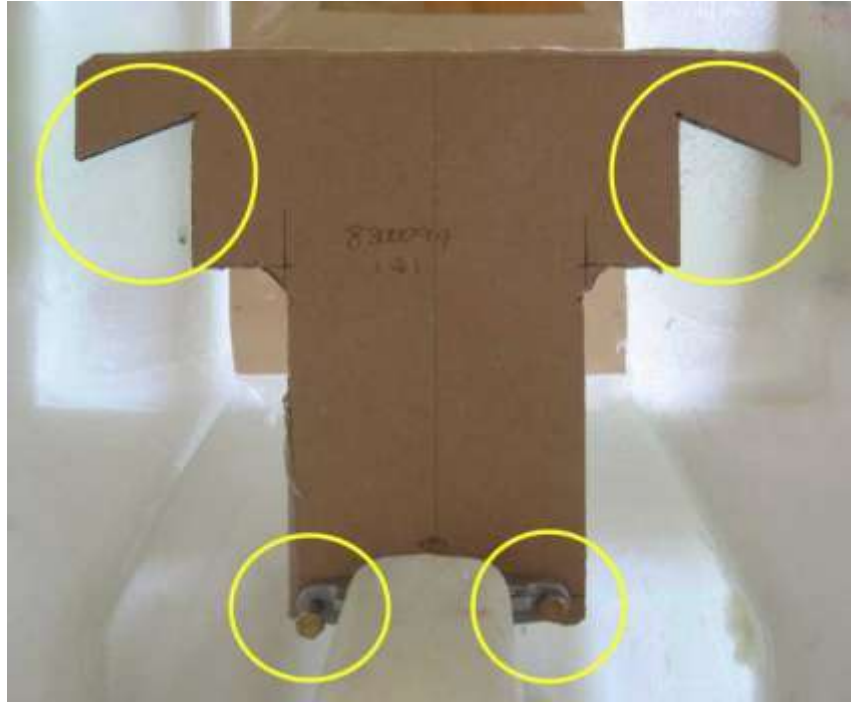

Working with one bracket at a time, hold the bracket in place in the angled part of the template (circled at the top of the top photo) and carefully mark around the outside and bottom edges.

Remove the template.

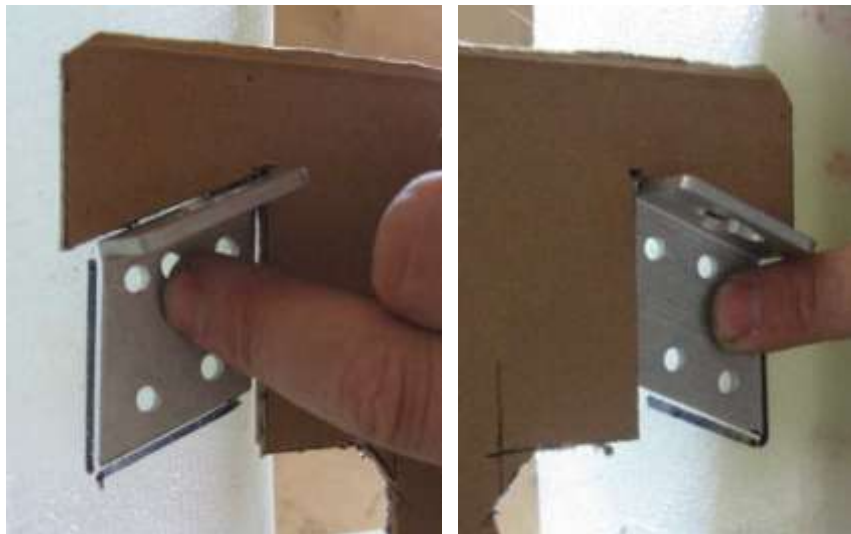

Drill the aileron cable bracket rivet holes

Working from the rear of the seats, hold each bracket against the seat back so that the outside and bottom of the bracket is in line with the marks on the seat back. Hold the bracket firmly and drill the bottom outside hole through the seat back.

Place a rivet into the hole in the bracket to position it, check that the bracket is still lined up with the marks and drill the inside top hole.

Place another rivet into the inside top hole and drill the outside top hole.

Make sure that all the rivets fit snugly through the seat back and into each bracket, then remove all the rivets and clean all the holes carefully – there must be no burrs or rough edges remaining.



Attach the aileron cable brackets

Sand the back of each aileron cable bracket as well as the positions on the seat backs where they will be placed.

Clean all surfaces to be joined.

Prepare a small mix of resin and use a brush to undercoat the positions on the seat backs where the aileron cable brackets will be placed.

Add flock to the resin and apply an even layer of flock approximately 2-3mm thick to the back of each aileron cable bracket.



Working on one bracket at a time, place a rivet through the bracket and into the seat back and rivet in place. Repeat the process with the top outside and top inside rivets.

Using a little resin on a clean mixing stick, clean any squeezed-out flock from the brackets.

This completes the *Pre-Paint>Fuselage>Interior>Fit aileron cable brackets* task.



Pre-Paint>Fuselage>Interior>Fuel system

Objectives of this task:

To install the fuel system from the wing tank connectors to the firewall fitting.

The fuel system consists of wing tanks (covered in the *Wings* tasks) that flow to a header tank situated behind the right-hand seat and then through a filter and an electronic pump to a shutoff valve located beside the pilot and then through a firewall fitting to the engine.

Note that the fuel lines to the wing tank fittings and the fuel line to the firewall will all be fitted in this task and then sealed off for later final connection.

Materials required:

Card # J11 'Fuel Components'

Fuel header tank ►

Blue fuel line, black fuel line and clear fuel line sheathing

Lock wire

Epoxy Resin and Flock, 5-minute Araldite



Assemble and test the header tank

Start by assembling the fuel fittings and pressure testing the header tank. Make sure that there are no foreign objects in the tank, then loop the inlets and breather holes (all at the top front of the tank) together with short lengths of line (it doesn't matter in what order – this is just to seal the tank for the pressure test) then fit the quick drain with a drop of Loctite 577 and tighten firmly. Fit an O-ring to the finger filter and fit into the outlet hole, once again with a drop of Loctite 577 and tighten firmly, then connect a short length of line to the finger filter and apply a small amount of pressure by blowing into the line, seal and check for leaks by spraying soapy water over the tank and fittings and check for bubbles.

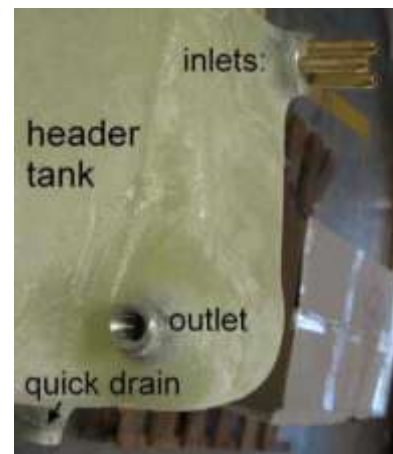

Fit the header tank to the enclosure

The header tank sits in the header tank enclosure behind the right-hand seat (the enclosure was fitted in the *Prepare fuselage* task) and is held in place with the enclosure lid, which also forms the luggage floor when it is fitted.

Fit the 2 brass nipple fittings to the inlet and outlet of the pump – in each case use a drop of Loctite. Fit the electronic fuel pump, with the flow arrow facing towards the front of the aircraft, to the floor of the enclosure with 3/16" countersunk screws and Tinneman washers from underneath the fuselage, through the pump mount and secure with Nyloc nuts.

Araldite a square of rubber sheet and a piece of sponge to the inboard side of the pump, the side that will contact the side of the tank. Araldite a 50mm square of rubber sheet to the front of the enclosure and then sit the tank in place and check that the quick drain is centred in the hole. Add more rubber sheet to pack the tank back if required.

Now fit a length of rubber sheet to the floor of the enclosure that is wide enough to prevent the tank from contacting the floor at any point.

At this point the tank is positioned fore and aft by the quick drain fitting through the floor and the rear of the tank is touching the padded side of the electronic fuel pump, so now you will need to cut dense foam or timber packers to hold the tank from moving sideways or backwards.

The photo at right shows a fitted tank – note the location of the 3 packers (circled): 1 at the rear of the enclosure and 1 on each side. Each packer has a piece of rubber sheet on the end that touches the tank and the other end of each packer is flocked to the side of the enclosure.

Note that the packers do not go all the way to the bottom of the enclosure – the space under the packers is where the fuel line is routed from the tank to the filter and then to the pump.

Cut and fit the packers and when you are satisfied with the fit then flock each packer to the side of the enclosure. When fitted correctly you will be able to take the header tank out of and into the enclosure. Add a strip of foam to the top of the tank where it will touch the lid and the tank is fitted.

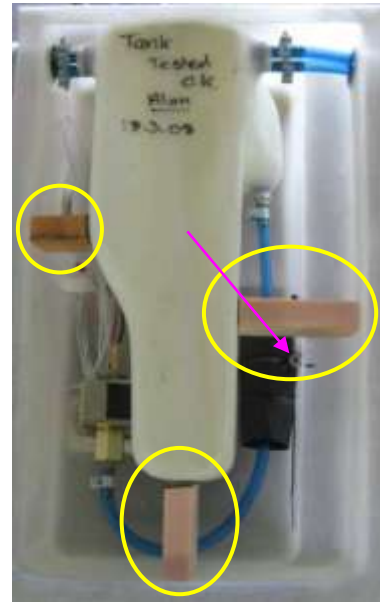

Plumb from the header tank

As you can see in the photo above right, the filter is located just behind the right-hand packer, so cut a short length of blue fuel grade tubing to suit, then cut a longer length to run from the outlet of the filter to the inlet of the fuel pump. Check that the filter is correctly positioned, with the flow arrow facing in the direction of the fuel flow, which is from the header tank to the filter and from the filter to the pump, then use the supplied hose clamps to fit each length of tubing into place. Wrap the filter with rubber sheet and fix in place with 2 zip ties. 5 minute Araldite the supplied bracket (arrowed above) in place and zip tie the filter to the bracket.

Plumb to the header tank

Cut 3 lengths of blue fuel grade tubing at 990mm and another 3 at 1300mm. The shorter ones will run from the header tank to the right-hand connector and the longer ones will run from the header tank to the left-hand connector. Cut 2 lengths of the clear sheathing, 1 at 950mm and 1 at 1250mm.

Fit the 3 shorter lengths of blue fuel grade tubing to the ferrules on the right-hand front of the header tank, and mark the other end of each line by wrapping short length of cloth tape around the line and marking it either **Breather**, **Front** or **Rear** as appropriate.

Fit a hose clamp to each line and tighten firmly.

Feed the lines out through the grey plastic fittings in the upper side of the enclosure (arrowed in yellow at right) and slip the sheathing over the fuel lines and over the grey plastic fitting (arrowed in purple at right) and then lock wire the sheath to the grey plastic fitting.

Repeat the process for the left-hand fuel lines, which will pass in front of the support rib as shown at right.

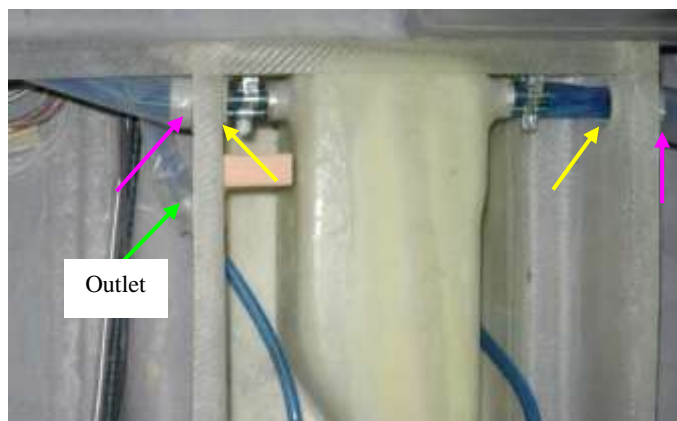

Fit the tank connectors

The tank connectors must be fitted the correct side of the aircraft: when fitted out through the slots in the tops of the cabin walls the brass ferrules must face forwards, towards the front of the aircraft, while the circular sleeve and ferrules will face downwards inside the cabin, allowing the fuel lines to run smoothly to the header tank.

Working on one side at a time, place the tank connector through the slot in the top of the cabin wall and check the length of the fuel line sheath, which will be slightly too long.

Trim the sheath to length then fit each fuel line to the correct fitting on the circular inboard part of the connector: the **Breather** line connects to the outside ferrule, while the **Front** line connects to the centre and the **Rear** line connects to the inside.

Fit the sheath over the circular ring and lock wire into place as shown at right. Note that the right-hand side connector is shown. Seal the open ends of the connector with tape and repeat the process on the left-hand side.

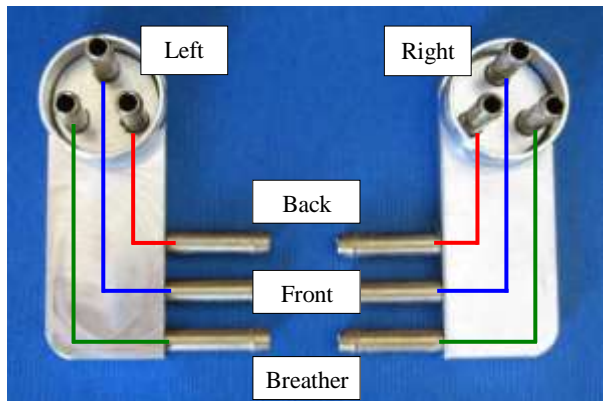

Fit the fuel tap and fuel line

Remove the lever from the fuel tap and set it aside.

Look for a mark or pilot hole on the left-hand side of the centre console around 50mm in front of the base of the armrest and 30mm below the forward section of the console as shown at right:

Drill a 16mm hole at that position.

Working through the access hole in the right-hand side of the console, hold the fuel tap in position against the inside of the left-hand side of the console and mark the positions for the alignment pin and screw holes, which will be visible through the fibreglass, then remove the fuel tap and drill the holes. Pre-fit the fuel tap with the two screws and then remove the tap and set it aside.

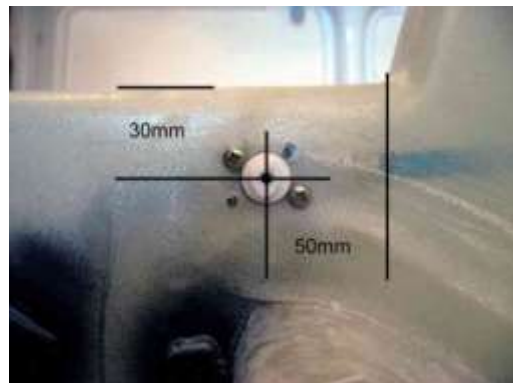

Cut a length of blue fuel hose of sufficient length to reach from the fuel tap all the way back to the electronic fuel pump outlet plus ~100mm, and a length of black fuel hose of sufficient length to reach from the fuel tap down along the floor and back up to the firewall fitting plus ~100mm.

Fit both fuel hoses to the fuel tap and secure with the supplied hose clips, making sure that the flow arrow on the face of the fuel tap is facing towards the black (outlet) fuel line.



Place a length of fuel line sheathing over both fuel lines and secure with lock wire to each boss on the fuel tap.

Fit the fuel line/sheath and tap assembly: tape over both ends of the fuel lines to prevent foreign objects from entering and then insert the blue fuel line end into the console through the access hole in the right-hand side and feed the blue fuel line down and back towards the rear of the fuselage and into the lower part of the console.

Feed the fuel line back until it can be seen in the hole in the lower longitudinal rib under the beam behind the seats, then, using a length of wire with a hook in one end, lift the fuel line and sheath out of the lower longitudinal rib and run it back beside the header tank enclosure.

Keep feeding the fuel line back until the end of the black fuel line and sheath can be inserted into the access hole in the console and then feed the fuel line/sheath down and forwards, taking care to route the line *under* the trim pivot, until it can be lifted out of the hole in the forward section of the lower console behind the rudder pedals.

Using a length of wire with a hook in one end, reach down into the console through the right-hand access hole and lift the fuel line assembly up and move the fuel tap into position.

Mount the fuel tap to the console with the two screws.

Cut the end of the blue fuel line and sheath to the correct lengths and connect to the electric fuel pump with a supplied hose clip and then lock wire the sheath to the grey plastic ferrule on the header tank enclosure (arrowed at right).

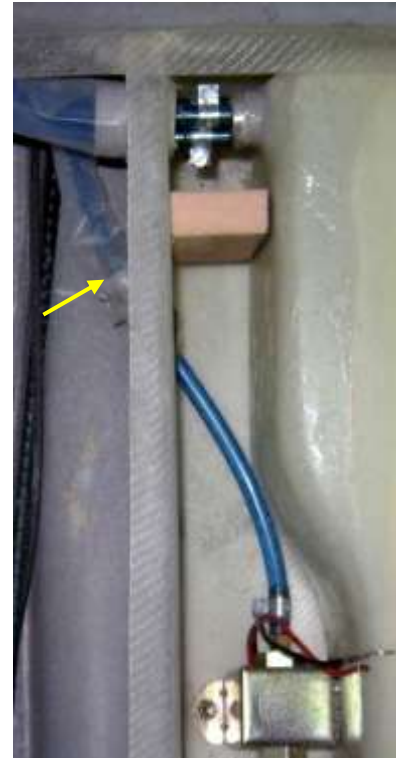

Cut the black fuel line and sheath to length and clamp the fuel line to the firewall fitting and lock wire the sheath to the firewall fitting collar. Cover the open (top) end of the firewall fitting to prevent dust or dirt from entering the fuel system.

Checks

At this stage you should have connected the fuel lines all the way from the fuel tank connectors through to the fuel header tank, then to the fuel filter, the electronic fuel pump, the fuel tap in the console and the black fuel hose which is connected to the firewall fitting.

Check that all the flow arrows on the fuel filter, the electronic fuel pump and the fuel tap are pointing in the correct direction, which is away from the header tank and towards the engine.

Check that all of the fuel line sheathing is lock wired in place and that the sheathing does seal the fuel lines correctly.

Check that all fuel lines are routed smoothly with absolutely no kinks and that there are no rough edges anywhere nearby that could rub against the fuel lines or sheathing, and then check that all of the open ends of the fuel lines are sealed so that no foreign objects can enter.

Coil the tank connectors and related fuel lines behind the seats where they will not be damaged during construction.

This completes the *Pre-Paint>Fuselage>Interior>Fuel system* task.

Pre-Paint > Fuselage > Interior > Fit seatbelt anchors

Objectives of this task:

This task shows how to fit the seatbelt anchors. While this is quite a simple task it is also an extremely important one – the seat belts *must* be anchored correctly because if you ever *really* need your seat belt (and here's hoping that you never do) it has to be attached to the airframe in the designed manner for maximum safety.

The photos that follow are of the pilot's seat: the same applies to the other seat but in reverse.

Materials required:

Card # J9 'Seatbelts'

Bottom anchor brackets

Both inner bottom anchor brackets are attached to the main beam that runs behind the seats.

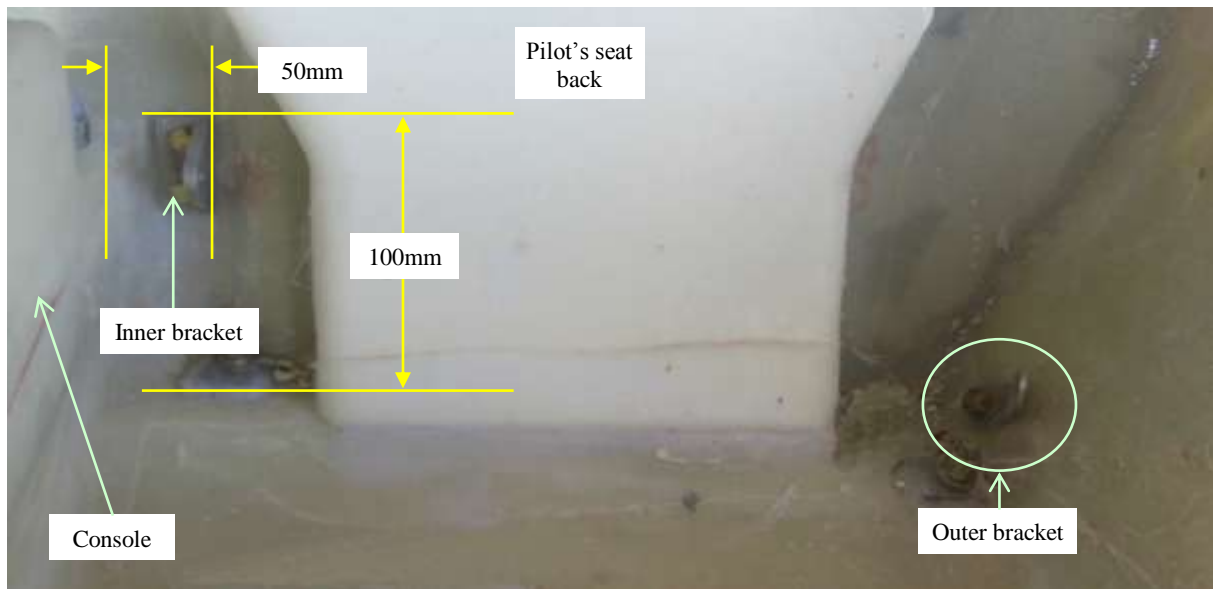

Start by marking a horizontal line 100mm up from the base of the main beam on the inside of each seat, and then mark a vertical line 50mm out from each side of the centre console.

Hold a bottom inner bracket inside and below where each pair of lines meet and drill a 3/16" hole through the top hole and slip a bolt through and then check each anchor bracket for square and drill the bottom hole. Fix each inner anchor bracket in place with AN3 bolts through the bracket, the beam, the rectangular backing plate, a washer and a Nyloc nut.

The bottom outer brackets are held with a single AN3 bolt and the hole is drilled from the outside of the fuselage: 25mm up from the main gear leg recess and 65mm back (left-hand side) and 75mm back (right-hand side) from the front of the recess: each bracket should sit in the lowest, rearmost corner inside.

Fix in place with an AN3 bolt through the fuselage from the outside, through the bracket with a flat washer and a Nyloc nut.

Tighten all the Nyloc nuts firmly.

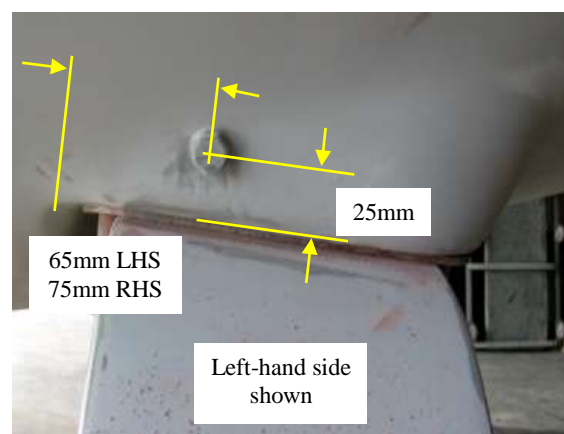



Top anchor brackets

The top anchor brackets mount behind the whalebone with the centre of the bracket precisely level with the bracing rib in front of the whalebone as shown at right.

Hold the bracket in position and drill a 3/16" hole at the top of the bracket and slip a bolt through then line up the bottom of the bracket and drill the second hole.

The top bracket will not be finally fitted until the aircraft has been painted and the upholstery has been installed.

Pre-fit the bracket in place with an AN3 bolt through the bracket, the whalebone, the backing washer and a Nyloc nut.

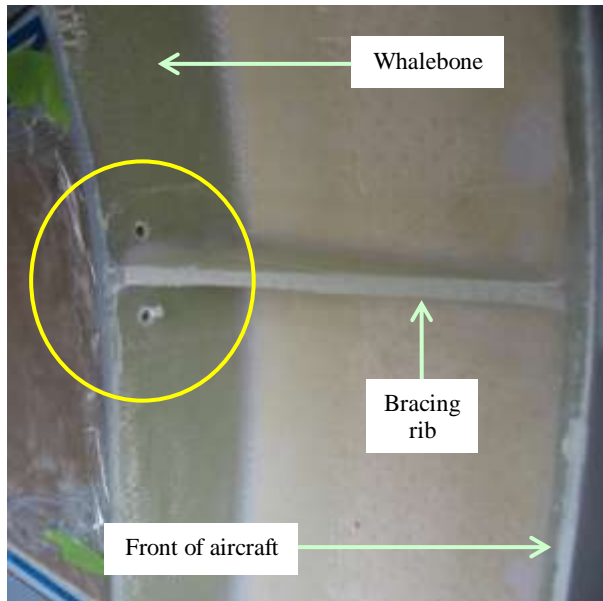

Remove and store the top brackets for later final fitting.

This completes the *Pre-Paint>Fuselage>Interior>Fit seatbelt anchors* task.

Pre-Paint>Fuselage>Pre-fit doors

Objectives of this task:

In this task you will size and pre-fit the doors to the fuselage and pre-fit the striker plate, all of which will be finally fitted after the fuselage has been painted.

In the photos that follow the pilots door is shown, however the exact same technique is used for each door.

Materials required:

Card # J1 'Doors'

5-minute Araldite and flock

Size the door

The door may require a slight trim to fit the opening: either tape the door in place or have a friend hold it firmly in place. Working from the inside, make sure that the door is centred in the opening and mark the inside of the door around the edge of the opening.

Remove the door and use a sanding disc to trim the door to the mark. Hold the door in the opening and carefully mark and sand as required until the door is a good snug fit all round.

Fit the hinges

Fit the top and bottom hinges to the arms on the door, then tape the door back into position and mark the centreline (vertically and horizontally) of each hinge screw. Remove the door and extend the marks to locate and drill each hole.

Trial fit the door with the hinge screws fitted and check that the door is sitting flush with the fuselage. If it requires adjustment outwards then an Araldite/flock mixture will be used to pack the hinges out the required amount.

Remove the door and roughen the area around each hinge screw hole to provide a good key for the Araldite/flock mixture. Apply wax to the hinge and screw to prevent them sticking to the flock and refit the door.

Loosely fit the hinge screws, then mix up a small batch of 5-minute Araldite and flock and pack the flock mixture behind the hinges as required, check that the alignment of the door and the fuselage is correct and leave the flock mix to cure.

Open and close the door a few times and mark any points that are binding then use a long sanding block to remove those points – the door should open and close smoothly with nothing rubbing at any point right around the opening.



Pre-fit the striker plate

Hold the outside door latch in the open (forward) position and close the door until the rear of the door is sitting flush with the fuselage and with an even gap top and bottom and, working from the inside of the cabin, carefully mark the vertical position of the latch pin on the door jamb.

Open the door and measure the horizontal distance from the outer door skin to the centre of the latch pin and mark that on the door jamb then drill a 1/2" hole at the point where the 2 lines cross.

Temporarily tape the striker plate to the door so that the latch pin is just through the hole in the plate then close the door carefully and, working from the inside of the cabin, mark the top and bottom of the striker plate onto the door jamb.

Remove the striker plate from the door and pre-fit it to the door jamb as shown in the photo above, with the plate sitting against the lip of the door jamb.

Do not rivet the striker plate into place; it will be finally fitted after the painting is complete.



Fit the top latch

Measure back 35mm from the top of the curve at the front of the door and drill a pilot hole and then a 3/4" hole down through the door frame. Refer to photo at right:

Fit the latch barrel up through the hole until it is about 2mm above the top of the door jamb and mark that position, then

flock the barrel into position with 5-minute Araldite and flock.

Make sure that the open end of the barrel faces upwards as shown in the photo above. Smooth the flock to a uniform radius around the top and bottom of the barrel and leave to cure.

With the door closed, hold the top front of the door flush with the fuselage and drill a 3/8" hole up through the latch-pin hole in the barrel and through the door jamb.

Open the door and fit the latch pin to the barrel from the bottom with the rubber sleeve and circlip fitted from the top as shown above. Test the latch for free but firm movement.

Fit the top handle 30mm behind the top latch – mark and drill the screw holes through both surfaces then drill the top holes to 1/2" for access to the screws.

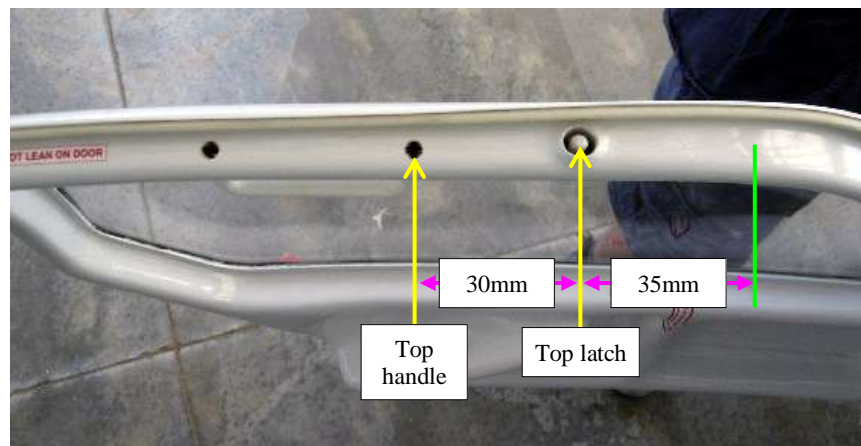

Final fit the door

Shut the door using both latches and check right around the door to see if there are any areas that need final adjustment, for example if the door does not fit easily inside the opening, and sand to fit as required.

Fit the fairing to the top hinge

Centre the fairing on the top hinge and tape it in place then test that the door can open and close freely and make adjustments to the hinge arm slot as required then fix in place with 5-minute Araldite and flock.

Test that the door can open and close freely and adjust the clearance of the hinge arm slot if required.

Cut and fit a section of glass sheet to the hinge arm (arrowed at right) to suit the opening in the fairing and fix to the hinge arm with an Araldite/flock mixture and leave to cure.

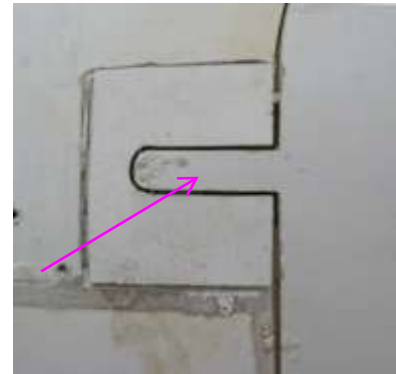

Fit the fairing to the bottom hinge

Centre the fairing on the bottom hinge and tape it in place then test that the door can open and close freely and make adjustments to the hinge arm slot as required then fix in place with 5-minute Araldite and flock.

Test that the door can open and close freely and adjust the clearance of the hinge arm slot if required.

Cut and fit a section of glass sheet to the hinge arm (arrowed at right) to suit the opening in the fairing and fix to the hinge arm with an Araldite/flock mixture and leave to cure.

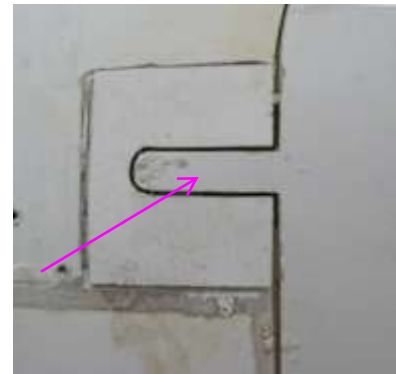

Fit the key lock

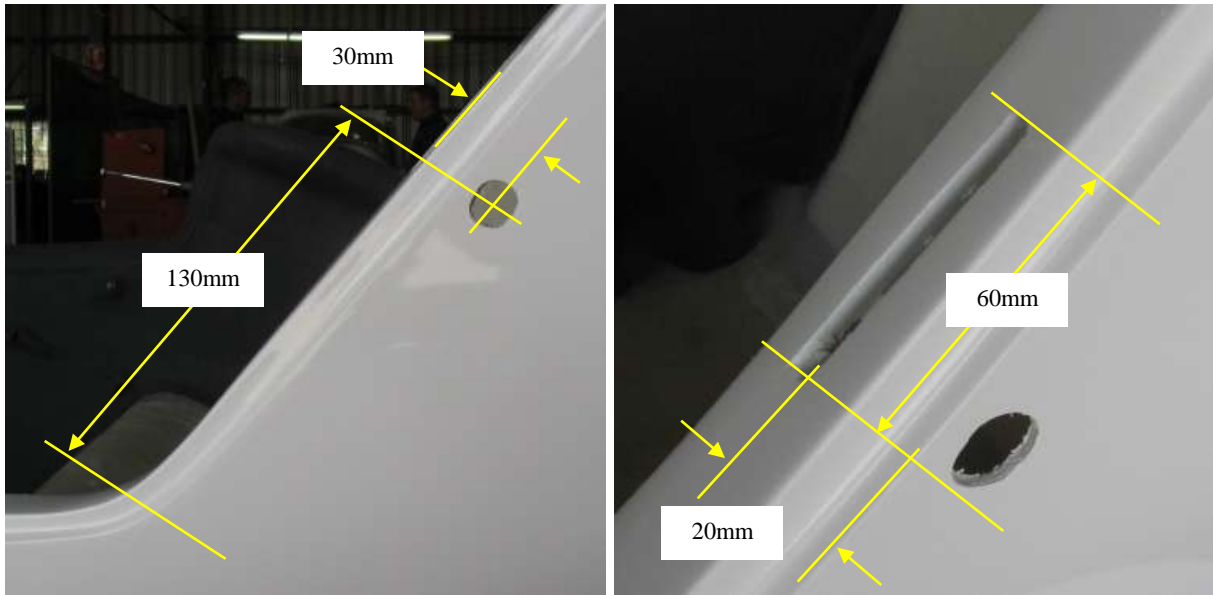

Mark a position 30mm out from the rear of the opening and 130mm up from the bottom of the opening and drill a pilot hole, then drill out to 18mm and elongate the hole with a round file until the door lock barrel can be mounted snugly into the hole.

Now mark and cut a slot 60mm long and 6mm wide 20mm in from the fuselage skin in the door opening, with the bottom of the slot square with the bottom of the lock hole. This is the slot that the lock arm will operate through. Close and latch the door and mark the slot onto the back of the door – use a builder's pencil or any similar thin marker and mark through the slot.



Cut the slot in the back of the door and check that it matches the slot in the door opening.

Fit the lock barrel into the 18mm elongated hole and secure with the large nut, then fit the lock arm, which will need to be bent slightly in order to swing freely into the slot.

Turn the key so that the top of the key moves forward and fit the arm in the locked position.

Test that the door can be locked and unlocked with no binding of the lock arm.

Leave the doors fitted for now, they will be removed later in *Painting > Pre-paint disassembly*.

This completes the *Pre-Paint > Fuselage > Pre-fit doors* task.

Pre-Paint>Fuselage>Fit windows

The windows are formed from strong but brittle acrylic and care must be taken to avoid marking or cracking the windows while they are being fitted. The windows are fixed in place with flock and *without* screws, however screws *are* used around the windows to hold the windows in place while the flock cures and are then removed.

Any minor shaping of the windows that may be required must be done with an 80 grit sanding disc or a hand-held sanding block: you must *never* use a jigsaw on acrylic.

The description and photos that follow show the window being fitted to a pilot's door, and the exact same technique should be used for any window.

Materials required:

Epoxy resin and flock, wax

¼ x ¼" adhesive-backed foam strip

8G self-tapping screws in heavy duty (coax) cable clamps:

Pre fit the window

Start by carefully sanding away all of the gel coat from the joggle, then fit a length of the ¼" foam strip around the very inside of the joggle (the dark grey line in the photo below) – this will keep the flock from making a messy line around the inside of the window and give a nice clean edge when the window has been flocked into place.

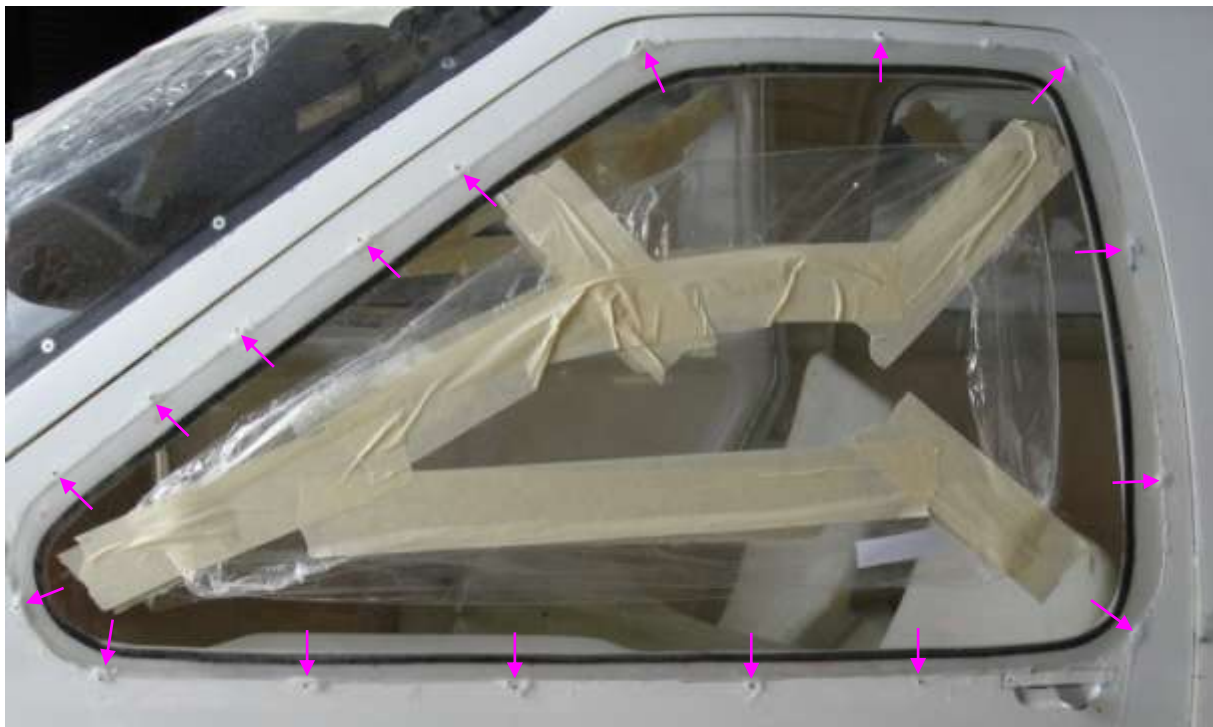

Close and latch the door and then test fit the window, holding or taping it in place and making any minor adjustments that may be required so that the window fits snugly inside the joggle.

Remove the window and, working very carefully, drill 1/8" screw holes in the door frame just *outside* of the joggle as shown arrowed above. Note in the photo of a completed window above that the protective plastic sheet has been folded and taped back from the edges of the window so that the bulk of the window area is still protected from scratching.

Prepare the window

Remove the window carefully and clean and blow away any dust and debris from the joggle.

Place the window face down on the bubble wrap packing material, taking care not to allow anything to scratch the surface, and carefully sand around the entire **inside** edge with emery tape – sand only to a point just short of the inside of the joggle, level with the centre of the ¼” foam strip.

By holding the emery tape as shown you can use your finger to control the width of the sanded area.

When the sanding is complete blow away the dust and then use a clean soft cloth and wipe right around the window.

Do **not** use any cleaning agents on the window.



Fit the window

Close and latch the door, wax the self-tapping screws and cable clamps and then wash and dry your hands to prevent wax from getting onto the window or the joggle.

Mix a batch of resin and coat the joggle, then add flock to the resin and fill the entire joggle out to the level of the foam strip. Carefully place the window into the bed of flock - start at one corner and position the window until the alignment is correct and it fits inside the joggle - and then gently press it into position.

Once the window is positioned correctly, take the self-tapping screws and cable clamps and start fitting them around the door frame as shown at right, working from the corners first and then the middle screws and so on.

The clamps will pull the window into the joggle level with the door frame and the wax will allow easy removal once the flock has cured, while the screw holes will be filled during the *Paint Preparation* tasks. Take care not to over tighten the screws, tighten them just enough so that the edge of the window is level with the adjacent door frame.



Check all around to see that the flock has keyed to the window: the sanded surface of the window edge will appear to go clear with no bubbles when the flock is in full contact with it. It may be necessary to gently squeeze the window to remove any bubbles, although if you have filled the joggle with flock there should be full contact anyway.

When you are satisfied that the window is positioned correctly wipe away the excess flock with a clean mixing stick, taking care not to smear any resin or flock over the window: always wipe out and away from the window. Refer to the photo of a completed window on the previous page for an example of how it should look. Leave overnight to cure. Next day remove the screws and cable clamps.

The same process should be used for all the remaining windows. You may do more than one window at a time if you are confident of your ability to do so but we would suggest that one window at a time is a great way to start.

This completes the *Pre-Paint>Fuselage>Fit windows* task.



Pre-Paint > Fuselage > Wheel alignment

Objectives of this task:

To ensure that the main wheels are correctly aligned.

Overview:

Some aircraft have reported shuddering through the undercarriage and airframe on rotation or landing. The amount of shuddering seems to be variable, depending on the all up weight of the aircraft. Investigations on factory built aircraft have revealed that this phenomenon is caused by a combination of two factors: toe-in or -out and the camber of the main wheels.

This procedure outlines how to check the wheel alignment and make the necessary adjustments to correct the issue. It's a fairly basic technique, but we've had success with it.

Procedure:

Firstly, a reference point is required from centerline (longitudinal axis) of the fuselage. This can be achieved by dropping a plumb bob down from the tip of the spinner, and one from the ventral fin and then, using a string line, join the two points. As seen in the picture below, we have used the join line in the concrete slab as the reference line.



Place a straightedge (we've found a length of box section to be the best) along the outside wall of the tire, and eyeball from above to check that both the tire and the straight edge are parallel.



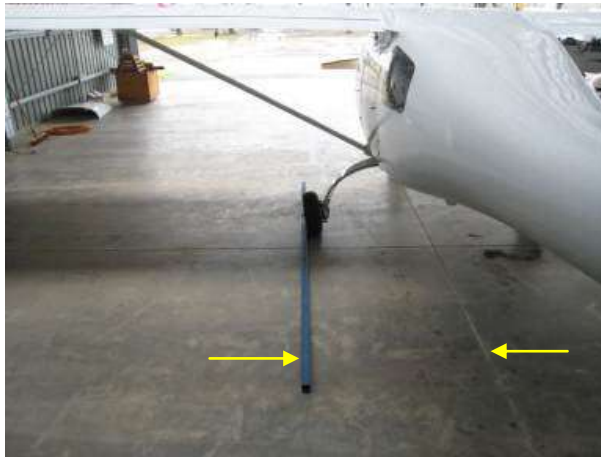

Mark the position of the straightedge in both forward and aft positions and join the two points, repeating the same procedure for the opposite side.

Take measurements from the straight edge positions to the centreline of the fuselage, repeat for the opposite side and compare the numbers to see if the wheels have toe-in or toe-out. The wheels will naturally want to rotate outwards when the aircraft is at gross weight, so it is recommended to have a slight amount of toe-in to allow for this.

If adjustments are required, washers are used as spacers between the stub axle and the undercarriage leg. Typically 2 washers are required on each of the lower stub axle mounting bolts to give the wheel slightly less camber, and usually only one half size washer installed on either the front or the back two stub axle bolts is sufficient to shift the toe in/out.

Pack with flock, reinstall and tighten and leave overnight to cure before using the aircraft.



Pre-Paint > Fuselage > Pre-fit wheel spats

Objectives of this task:

To pre-fit the spats to the main wheels and the nose wheel. This is a task that will require several trial fits, and it should be done in the stages described below.

Main wheel spats

The main wheel spats are held in place by a single bolt on the outside that fits into the axle extension and 4 screws on the inside that fit to the spat mounting plate. The inside holes (arrowed at centre right) should all be countersunk to accommodate Tinneman washers.



Prepare the spats by trimming out the bottom of the wheel opening as shown above – once the bottom opening is correct the spat can be test fitted and the gear leg opening shaped to suit.



Mark back 55mm from the axle bolt hole and drill a 1 1/8" hole for access to the valve as shown above left. Slip the spat down over the wheel until the outside axle bolt hole lines up with the axle extension: you will probably have to trim the main gear leg opening slightly to get the spat fully down over the wheel. A typical inside cut is shown marked above right, but check your own spat to main gear leg fitting then mark and trim accordingly.

Fit the spat into position with the axle bolt and the inside screws and make sure that there is a gap between the main gear leg and the top of the spat that will allow the hydraulic brake line to pass through without any risk of chafing on the spat.

Loosen the 2 top bolts that hold the spat mounting plate – one hole is slotted to allow adjustment – and rotate the spat until the top rear is 9" (230mm) above the ground, then tighten the bolts.

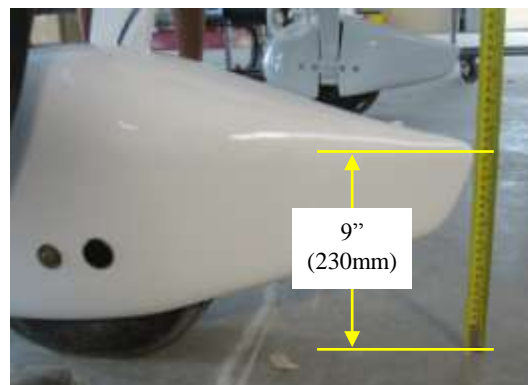



Check that the tire has about 5mm clearance all round the bottom of each spat, then remove the spats and set aside for painting. Completed main wheel spats are shown above.

Nose wheel spat

The nose wheel spat is in 2 sections, front and back. The front section is fitted to the nose wheel with the axle bolt and a single threaded screw into each side of the nose leg yoke, while the rear section is attached to the front section with 8 x 3/32" screws into captive nuts.

Start by fitting both sections together and taping them to each other, then drill 3/32" holes around the join, 4 on each side, for the captive nuts that will hold the 2 halves together as shown at right.

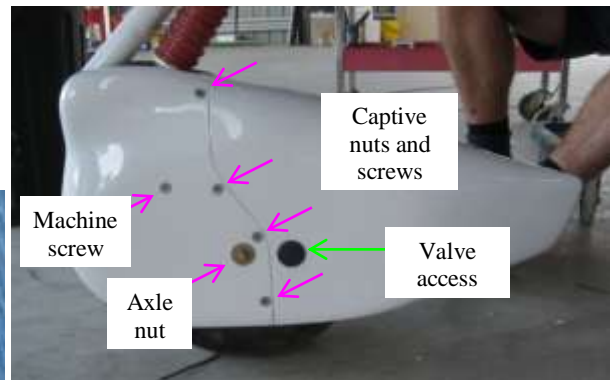

Countersink the screw holes in the front section and fit captive nuts (shown above) to the rear joggle – use countersunk 3/32" rivets to hold the captive nuts in place.

Screw both halves of the spat together and check the fit around the gear leg opening in the top of the spat. Trim the gear leg opening so that it is even on both sides. The opening should look like the example shown at right: note that the rear of the opening (arrowed in green) is slightly *behind* the join line.



While the spat halves are screwed together, measure back 55mm from the axle bolt on the left-hand side only and drill a 1 1/8" hole for access to the tire valve.

Grind out a gentle notch in the joggle of the rear section of the spat (as circled at right) to allow clearance for the front axle spacers.

Captive nuts fitted to the joggle can be seen in the photo at right.



Now both halves of the spat can be fitted to the nose wheel and held in place with the axle bolt, then the spat can be aligned and the hole for the machine screw in the yoke can be marked.

Support the front of the aircraft so that the nose wheel is off the ground and remove the front axle and wheel.

Fit the front of the spat over the yoke and refit the front wheel and the axle, passing the axle through the spat, yoke and wheel as shown at right.

Lower the nose wheel back onto the ground.



Fit the rear of the spat to the front section and move the back of the spat up or down until the whole spat sits level or slightly low at the back (the back will tend to move up as weight is added to the aircraft), then hold the spat in that position and mark the location of the holes for the machine screws on each side of the yoke. A completed nose wheel spat is shown below.



Support the front of the aircraft again so that the nose wheel is off the ground and remove both spat halves along with the front axle and wheel. Leave the wheel out of the yoke for the moment so that you will not accidentally drill through the yoke and into the tire.

Drill a 9/64" hole in each side of the yoke at the marked locations and thread to 3/32" UNF then refit the spat and wheel again, this time fitting the short 3/32" screws into the yoke.

Lower the nose wheel back onto the ground and check that the alignment is satisfactory and that the tire has about 5mm clearance around the bottom of the spat, then remove both halves of the spat, set them aside for painting and refit the nose wheel.

This completes the *Pre-Paint > Fuselage > Pre-fit wheel spats* task.

Pre-Paint>Wings>General

In our factory we combine several smaller tasks on the wing into the one three day operation: we work on the top surface first, starting with the fuel filler body and then the winglet, then we move to the wing root and install the fuel fittings, fit the breather tube and cut the recess for the flap arm. The next day we turn the wing over and work on the bottom surface, cutting the aileron cable mount inspection hole, fitting the flaps and the quick drains, and then on the third day we fit the ailerons. Other minor tasks, such as fitting the strobe mounts, can be done at any time.

In this section of the manual each step of the operation is broken out as one of a series of tasks that are ordered in the sequence that we would normally perform them.

The homebuilder could (and should) follow the same sequence but with the whole operation spread over several days, perhaps at a rate of one task per day.



We support each wing on a pair of trestles that place the wing at a convenient height for working, about 900mm high or bench height, and we cover the tops of the trestles in carpet to protect the wing surface. When working on the bottom of the wing we use a foam wedge on each trestle under the rear of the wing to stop the wing from rocking when the curved surface is facing downwards.



Tools *may* be placed on the wing surface while you are working but you *must* take care not to *drop* anything onto the wing surface – the surface is not designed for that type of loading, so treat it with respect and place your tools carefully and gently onto it.

Pre-Paint > Wings > Fit fuel tank filler body

Objectives of this task:

In this task the fuel tank filler body location will be determined for each wing, a hole will be drilled into the upper wing surface and a smaller hole will be drilled into the wing tank and then the filler body will be fitted and then flocked into place and covered with peel cloth while the flock cures.

Materials required:

from Card # J11 'Fuel Components' 2 x fuel tank filler bodies: →

Epoxy resin and flock



Mark the position of the opening

First we need to mark the side-to-side distance from the wing root to the centre of the *filler body* opening and in order to do this we must determine the exact length of the wing tank. To do this take the supplied breather tube and shape the end to a point as shown below. Feed the breather tube into the tank from the top front wing root fitting and carefully work it past the tank ribs until you find the end of the tank.



Mark the breather tube level with the wing root at that point then withdraw the tube and mark where the position of the end of the tank on the top of the wing. Measure back **150mm** from that point and that is the initial side-to-side location of the *filler body*. Repeat the process of finding the end of the tank and measuring back **150mm** on the other wing and then make any adjustments that may be required to make both *filler bodies* the same distance from each wing root. Mark this final side-to-side position of each *filler body*.

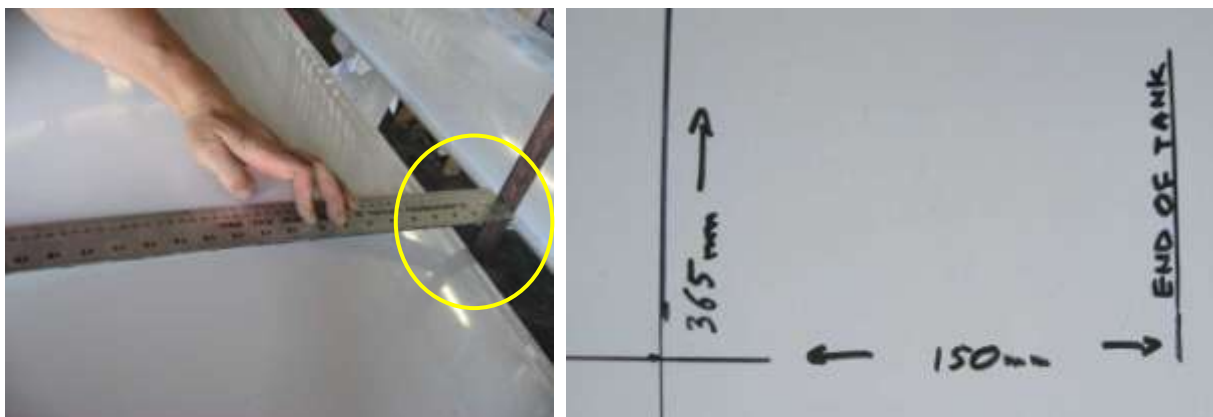

Take a set square and place it under the wing and against the leading edge and then measure back **365mm** from the leading edge – mark this fore and aft position of each *filler body*.

Cut the opening

Now we can drill through the outer surface of the wing with a hole saw, clean away excess filler and then drill a slightly smaller hole into the wing tank.

During cutting care must be taken to prevent any drilling waste from falling into the tank.

If you have a compressor and an air line with a variable flow valve you could place a line into the tank through one of the wing root fittings and **very slightly** pressurise the tank, but be careful to only use a **small** amount of pressure – too much pressure may rupture the tank! Otherwise you could have someone hold a strong vacuum cleaner nozzle near the hole saw while you are drilling, but whatever you do make sure that **no** waste falls into the tank.

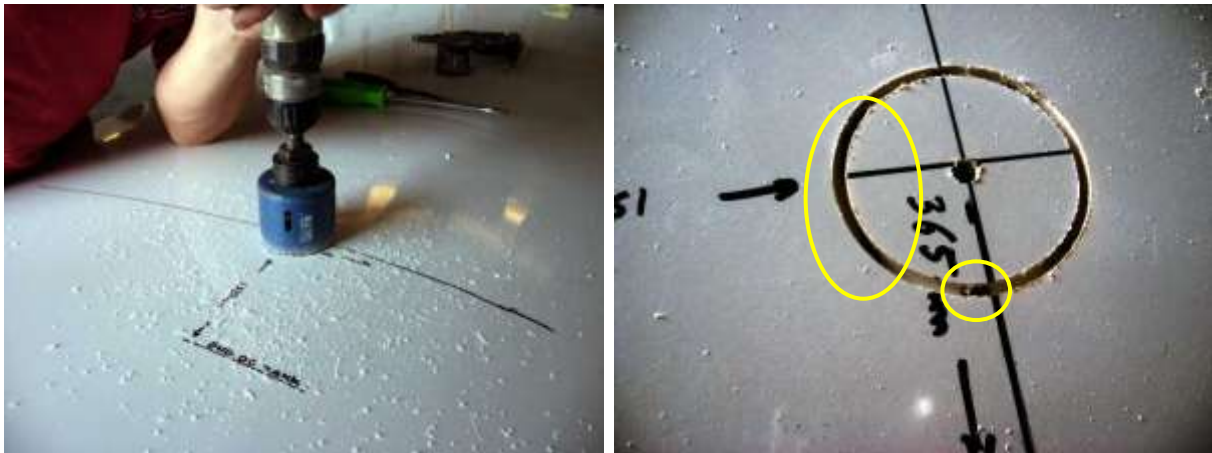

Drill a 66 - 68mm hole into the upper wing surface **only**, and **not** into the fuel tank. Hold the drill at right angles to the wing surface and very gently drill until you can see darkness at the bottom of the cut (as indicated in the yellow circles in the photo above right) this will mean that you have reached the gaps in the expandable filler between the upper wing surface and the fuel tank.

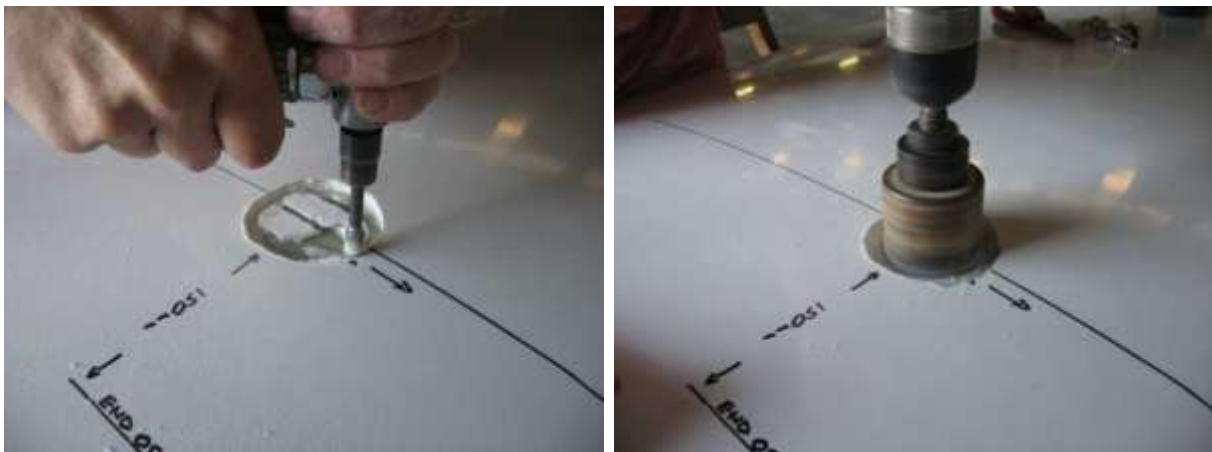

Lever out the cut out piece and carefully grind away all of the filler until you reach the top of the wing tank, then drill a 54mm hole into the tank, taking care not to drop anything into the tank.

In these photos, taken in our factory, the tank has been slightly pressurised so that all waste is blown away from any opening, but a vacuum cleaner hose held close to the surface being cut could achieve much the same result.

Fit the filler body



Now, working slowly, enlarge the hole in the tank (sandpaper taped to a section of tubing is useful for this) just enough so that the *filler body* is a good firm fit into the tank. Remove the *filler body* and clean all of the area surrounding the holes. Sand/roughen the outside of the *filler body* and place masking tape around the inside to keep flock from entering.

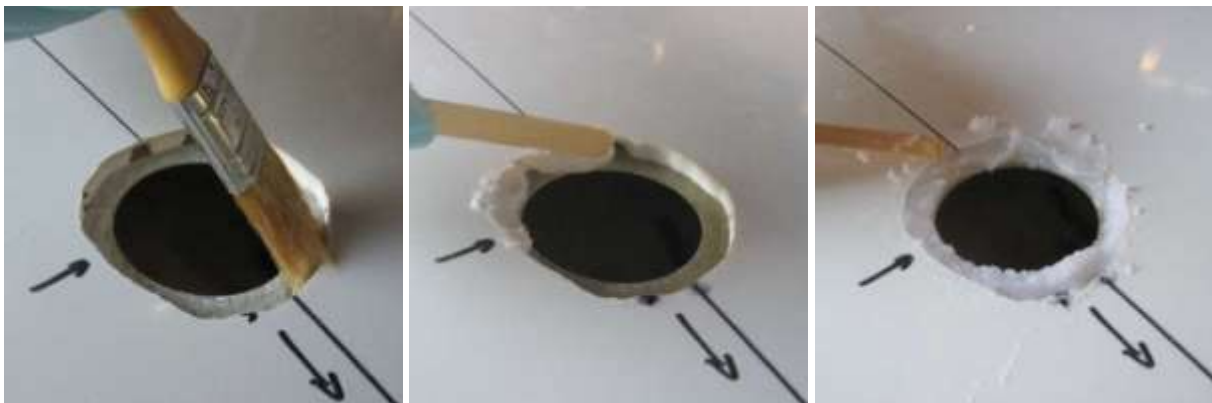

Mix a batch of resin and coat the outside of the *filler body* and the top of the wing tank area where it will be mounted. Add flock to the resin and carefully fill the area around the *filler body*, working the flock into the gap between the tank and the wing surface first and then filling back towards the opening, making sure that any bubbles are worked out.

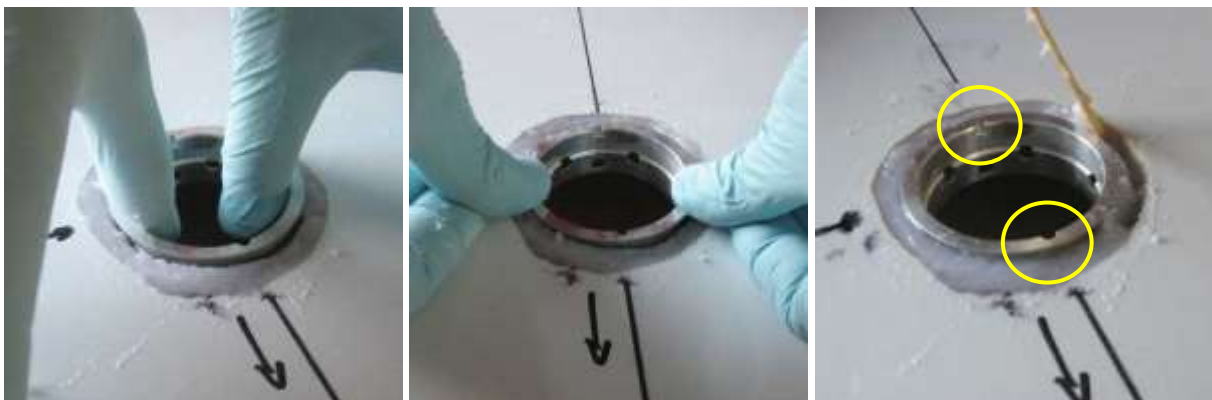

Place the *filler body* in position, aligning the locating holes (circled at above right) fore and aft and with the earth wire hole facing forwards, and level the upper rim of the *filler body* with the top of the wing surface. Flock and fill back around the *filler body*.

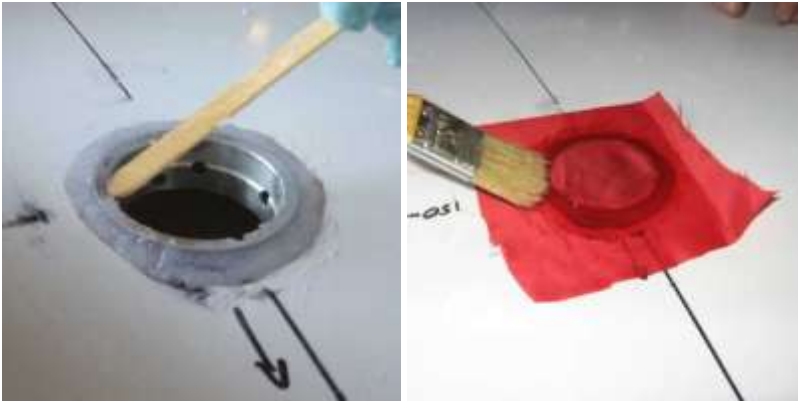

When the flock is almost level with the top of the wing surface, cut a piece of peel cloth and carefully brush it into place with no wrinkles or bubbles. Leave overnight to cure.

Next day remove the peel cloth and seal the opening with a square of plastic or heavy card secured with masking tape to keep the tank free of dust and dirt.

Final filling of any slight depressions in the flock will be covered in the *Painting>Pre-paint preparation* task.

This completes the *Pre-Paint>Wings>Fit fuel tank filler body* task.

Pre-Paint>Wings>Prepare wing root

Objectives of this task:

To fit all of the fuel and breather fittings in the wing root and trim the flap arm cutouts.

Materials required:

Card # J11 “Fuel Components”

Steps

1. Fit the fuel fittings
2. Fit the breather tube
3. Cut out the flap arm recess

Fit the fuel fittings

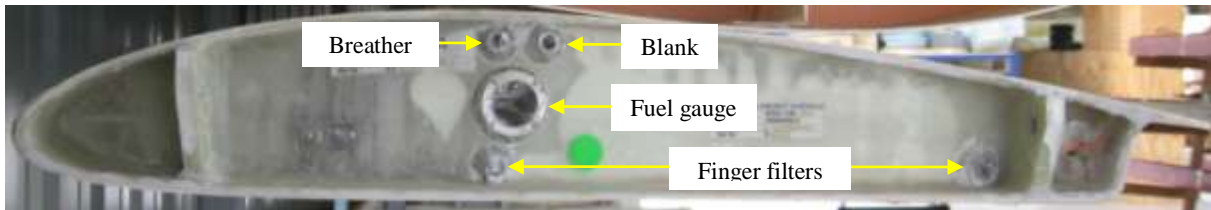

Start by removing all the protective tape from the openings, then thread a finger filter into each of the bottom fuel fittings and remove – this will clear any surplus sealant that may have accumulated around the fittings. Clean the finger filters and apply a smear of Loctite 577 to the threads then refit the filters and tighten firmly. Take care not to cross-thread any fittings.

Apply a drop of Loctite 577 to the threads of the blanking plug and fit to the top rear fitting.

Assemble the fittings onto the breather tube as shown and then insert the breather tube into the front top fitting and work it fully into the wing tank – there are cut-outs in the top of the tank ribs to allow the breather tube to fit along the top of the tank and it may be necessary to gently manoeuvre the tube through them. A very slight bend about 200mm back from the end of the tube can be useful. Push the tube in until the end of the tank is felt and then back it out roughly 5mm.



Once the tube is in place, apply a smear of Loctite 577 to the threads of the brass nipple and tighten it into the fitting, then do the same with the gland nut. The 90° curved end of the breather tube should face the rear of the wing and be horizontal when finally fitted.

Place a square of tape over the fuel gauge opening for the moment. Due to the breakable nature of the fuel gauge it will be calibrated and installed after the wing has been painted.

Fit the breather tube and the fuel cap

The breather tube will now be visible through the fuel filler opening on top of the wing.



Move it to the rear of the opening and behind the filler body, then take the plain earth wire and thread it into the tank from the filler and work it along the bottom of the fuel tank and through the gap in the bottom of each tank baffle towards the wing root as shown in the photo above. Proceed carefully until the entire length of plain earth wire is inside the tank.

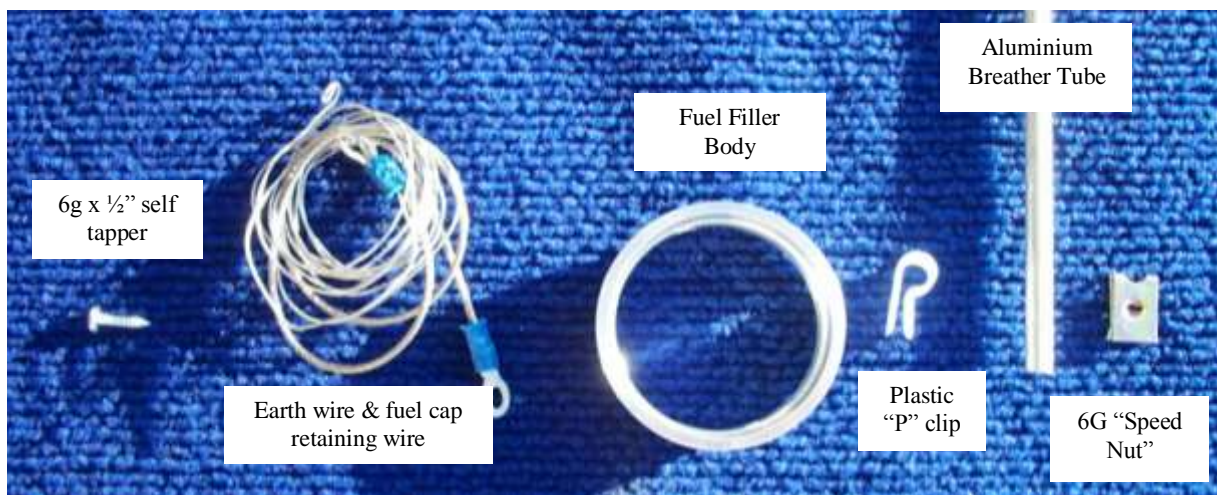

Fit the speed nut onto the “P” clip, fit the “P” clip around the breather tube and then fit the 6g self-tapping screw through the 4mm ring terminal, through the fuel filler body and into the speed nut on the “P” clip. See the drawing on the next page.

You may need to make up a tool to assist in the fitting of the “P” clip – here is a photo of the tool that we use in our factory for the purpose. The end (circled) is used to push the breather tube up and towards the fuel filler body so that the screw can be fitted. The tool is shown in use on the next page.



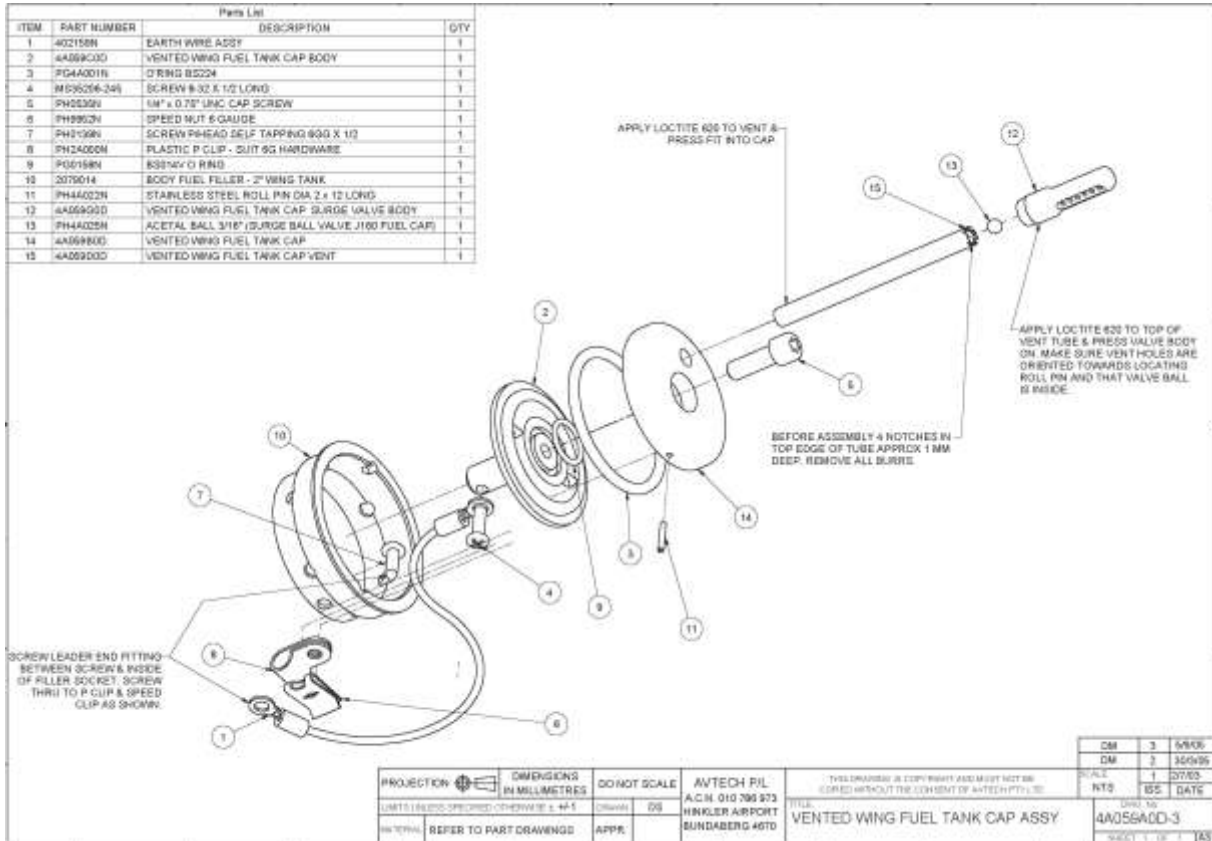

The drawing above shows the components and the process of assembly so that you can see how the parts all fit together, while the photo below right shows the actual fitting taking place in the fuel filler opening.

Note that the blue ring terminal will be pushed down to a horizontal position before the screw is tightened so that the earth wires will not foul the fuel cap when it is fitted.

The braided length of the earth cable is the fuel cap retaining cable and it should now be connected to the bottom of the post on the fuel cap with a 1/2" machine screw with a drop of Loctite 242 on it.

The fuel filler cap, which comes partly assembled on the card, can now be placed into the opening with the locating dowel fitted into the recess at the rear of the opening and tightened in place and the vent tube opening can be taped over until after painting.



The vent tubes will be fitted to the fuel filler caps when the wings are being prepared for final fitting in the *Post-Paint > Wings > Prepare wings for fitting* task.

Cut out the flap arm recess

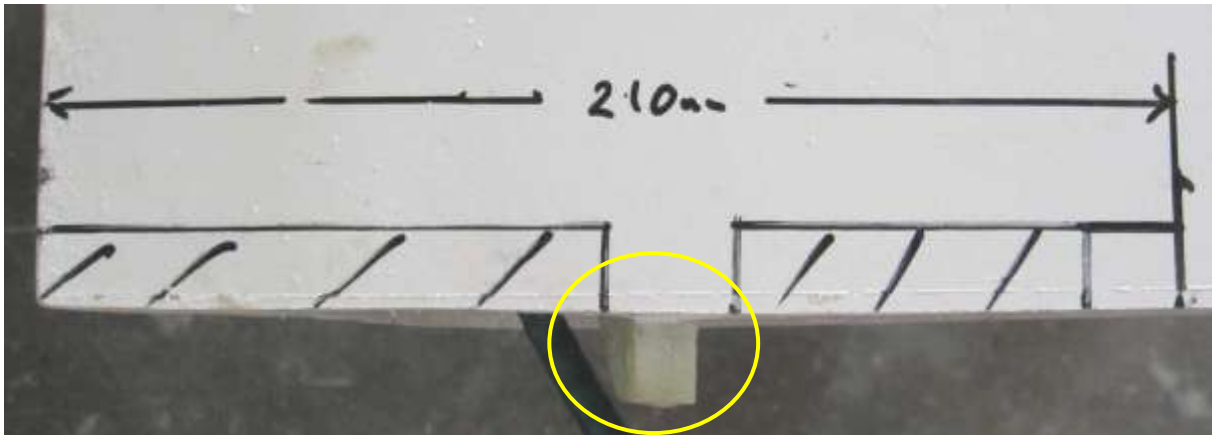

You will need to cut out the marked flap arm recess in the top of the wing root. Care is needed around the wing attachment lug (circled): under no circumstances must any material be removed from the lug.



When using a jigsaw near the wing attachment lug you will need to make sure that the shoe of the jigsaw is completely level when cutting near the wing attachment lug as shown above.

Use a hacksaw in a holder to remove the final section of the wing skin above the wing attachment lug, finishing off carefully with a flat file as shown above.



Cut down the rear of the wing as shown at right, angling out from where the saw is in the photo to finish the cut level with the bottom surface of the wing, shown indicated the red line.

Sand all cut surfaces to a smooth finish.

This completes the *Pre-Paint>Wings>Prepare wing root* task.

Pre-Paint>Wings>Cut aileron cable openings

Objectives of this task:

Check the position of the wing rib near the aileron cable inspection openings and then check, mark and cut the aileron cable openings.

Check and cut the aileron cable inspection opening

Turn the wing upside down and pack under the trailing edge so that the wing is stable.

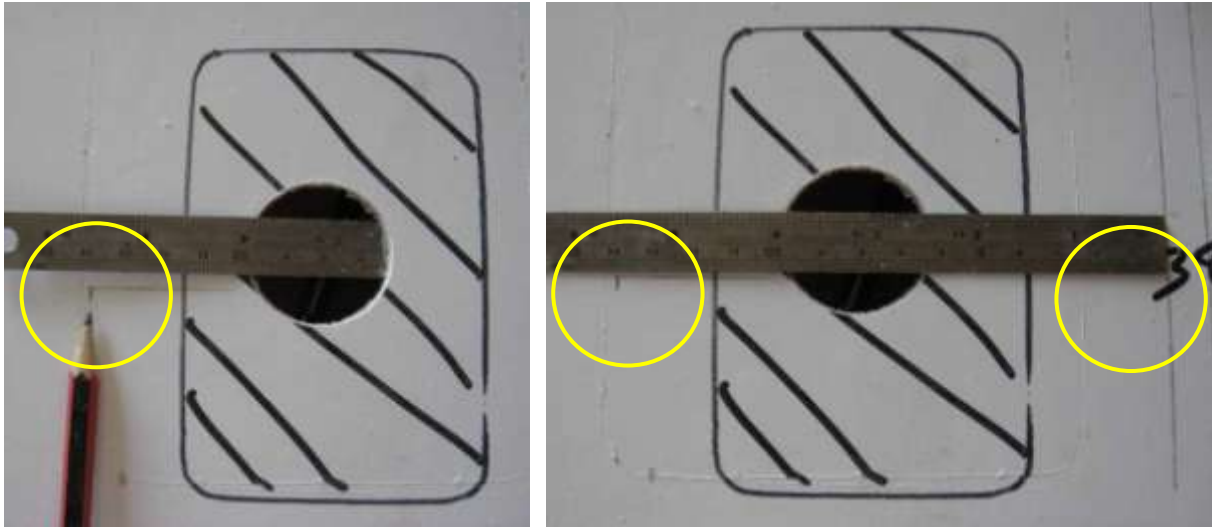

Start by drilling a 38mm hole in the centre of the shaded rectangular area, and then place a ruler into the hole towards the wing root until it touches the rib. Mark a reference line on the wing (140mm has been used as the reference circled in the photos above).

Now remove the ruler from the hole and lay it on the wing with the reference mark lined up and mark where the end of the ruler lies, which is where the outboard side of the rib is located, and draw a line fore and aft at that point. Measure 12mm from that line towards the wing root and draw another line: this marks both sides of the wing rib.

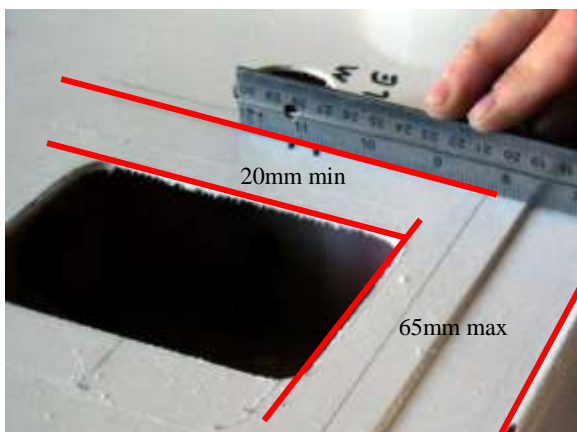

The position of the inspection hole should be no closer than 20mm from the outboard side of the rib and no more than 65mm from the trailing edge of the wing. If it is not then you will need to move the markings accordingly.

Use a jigsaw to cut the rectangular inspection hole slightly undersize and then carefully widen to 80mm wide and 120mm front to back with rounded corners to fit the clear cover (drawing on next page). Set the clear cover aside until after painting.

Parts List			
ITEM	PART NUMBER	DESCRIPTION	QTY
1	2A054A1D-2	INSPECTION PLATE SER III WING	1
2	5A048A1D-3	FAIRING SCREW SOCKET 4mm	4
3		8-32 BUTTON HEAD SCREW	4
4	5-32_WASHER	PLAIN (GAL) WASHER	4

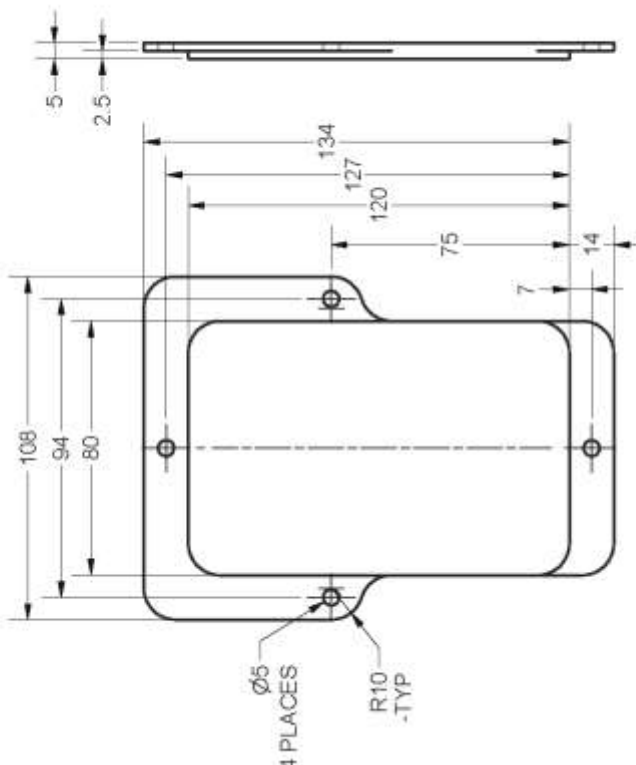

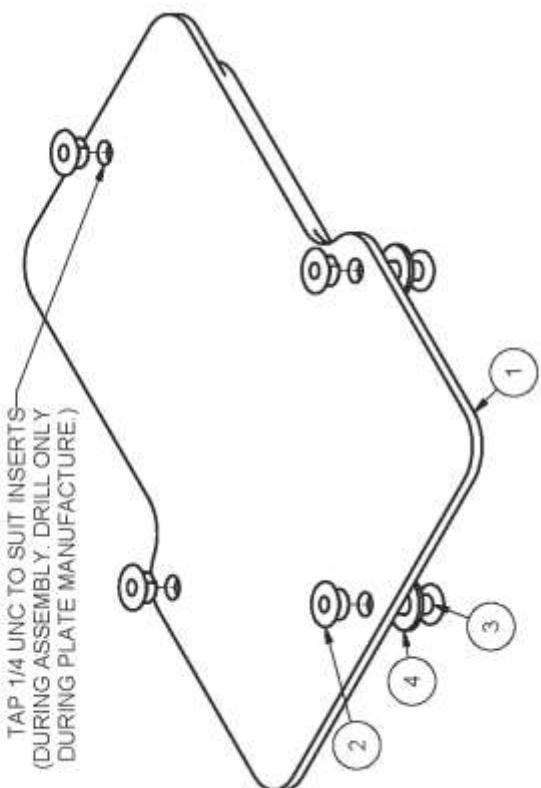

TAP 1/4 UNC TO SUIT INSERTS
(DURING ASSEMBLY. DRILL ONLY
DURING PLATE MANUFACTURE.)

THIS DRAWING IS COPYRIGHT AND MUST NOT BE COPIED WITHOUT THE CONSENT OF AVTECH PTY LTD	SCALE VAR	DS 2 18/2/06	1 14/2/06	ISS DATE
TITLE WING INSPECTION PANEL ASSY - MACHINED		DWG. No. 2A054A0D-2		
AVTECH P/L A. C.N. 010 786 973 HINKLER AIRPORT BUNDABERG 4670		DO NOT SCALE DRAWN DS		APPR.
DIMENSIONS IN MILLIMETRES GENERAL TOLERANCES WHOLE NO.'S ± 0.5 ONE DEC. ± 0.25 TOW DEC. ± 0.05 ANGLES ± 0.5°		MATERIAL TO PSJED-07		
PROJECTION 		5 THICK CLEAR ACRYLIC SHEET TO PSJED-07		

Now look into the hole that you have just cut – look for the black marks (arrowed at right) on the rib that shows the location of the aileron cable clamp bolt holes. Drill a second 38mm hole as shown at right, slightly inboard of the wing rib with the fore and aft alignment being exactly in line with the aileron cable clamp bolt holes. This hole will be used to access the rear of the cable clamp bolts.

This completes the underwing work, now we need to check the aileron cable slot marking on the upper wing surface.

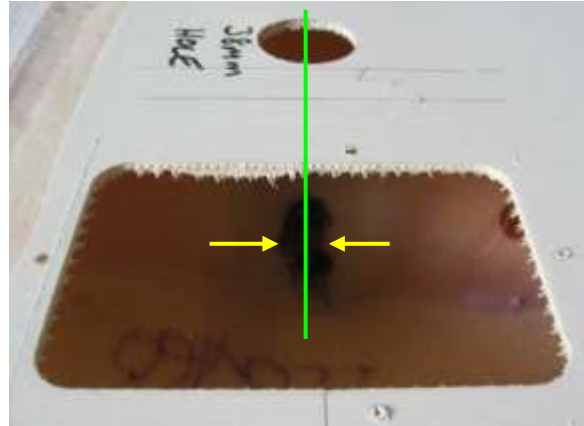

Check and cut the aileron cable exit slot



With the wing still upside down, lay a setsquare on the wing and use it to transfer the location of the **outboard** side of the wing rib to the upper wing surface. Mark the rib location and then turn the wing right side up.

It is critical that the aileron cable slot be accurately positioned in relation to the wing rib because the aileron cable will be clamped to the wing rib and it must align with the aileron drive arm. The aileron drive arm and thus the aileron is positioned in relation to the slot in the later task *Pre-Paint>Wings>Fit ailerons*.

The marked slot should be slightly (~2mm) outboard of the wing rib. If that is not the case then move the slot marking laterally until it is slightly outside of the wing rib. The fore and aft position of the slot will be correct as marked and the overall slot dimension should be approximately 15mm wide and 70mm long.

Once the location has been confirmed then cut the slot out: drill each end of the slot slightly undersize and use a jigsaw to join the holes then widen to the marked size with a file.

If the aileron cable inspection hole on the underside of the wing has been correctly marked then the aileron cable slot will usually be correct too, but it is still good practise to check carefully before cutting – it is much better to check first and *then* cut.

This completes the *Pre-Paint>Wings>Cut aileron cable openings* task.

Pre-Paint>Wings>Fit quick drain sumps

Objectives of this task:

To flock the quick drain sumps into the wing tanks at the rear of each wing root and then clean and seal the fuel tanks.

Materials required:

Epoxy resin and flock

Card # 11 'Fuel components'

Mark and drill the wing

Turn the wing upside down and wedge the wing so that the top surface is level and solid.

If you have a compressor and an air line with a variable flow valve you could place a line into the tank through one of the wing root fittings and **very slightly** pressurise the tank, but be careful to only use a *small* amount of pressure – too much pressure may rupture the tank!

Otherwise you could have someone hold a strong vacuum cleaner nozzle near the hole saw while you are drilling, but whatever you do make sure that **no** waste falls into the tank.

Now we can drill through the outer surface of the wing with a hole saw, clean away excess filler and then drill a smaller hole into the wing tank.

Measure the distance from the wing root to the first rib, which should be between 55mm and 60mm: that defines the inboard end of the wing tank. Now measure a further 40mm into the tank for a total of approximately 95mm to 100mm and mark a line, then measure back 580mm from the leading edge and mark another line. Where these lines cross is where the quick drain sump will be fitted.



Drill a 1 $\frac{3}{4}$ " hole into the outer wing surface **only**, and *not* into the fuel tank.

Hold the drill at right angles to the wing surface and very gently drill until you can see darkness at the bottom of the cut: this will mean that you have reached the gaps in the expandable filler between the wing surface and the fuel tank.

Lever out the cut-out piece and carefully grind away all of the filler until you reach the surface of the wing tank, then drill a 3/8" hole into the tank, taking care not to drop anything into the tank. You could turn the wing right side up for this step if you wish.

In these photos, taken in our factory, the tank has been slightly pressurised so that all waste is blown away from any opening, but a vacuum cleaner hose held close to the surface being cut could achieve much the same result.

Fit the quick drain sump body



Clean away any dust then sand and test fit the quick drain body.

Mix a small batch of resin and coat the quick drain body and the mounting hole, then add flock and bed the quick drain body into place.



Add flock to build up to surface level and smooth away any excess with a clean mixing stick. Make sure that no flock sets across the drain hole – clean away any excess inside the drain hole with a length of wire or similar. Leave overnight to cure.

The flock will be partly covered by the glass fibre cloth lay up for the flaps and any roughness in the finish will be rectified in the *Painting>Pre paint preparation* task.

Clean the wing tanks

The fuel system will be flushed through in the *Testing* phase prior to flight.

Next day thoroughly clean the fuel tanks to remove any dirt or debris that may have fallen into the fuel tanks during the construction process: vacuum inside the fuel gauge opening then remove the cover from the fuel filler cap and blow compressed air into the tank to move debris and at the same time hold a vacuum cleaner nozzle at the fuel filler and fuel gauge openings so that you have a continuous airflow through the tank.

When you are satisfied that the tank is clean, seal all openings into the tank: the fuel filler opening, the quick drain fitting, the fuel gauge opening and all wing root fuel fittings.

This completes the *Pre-Paint>Wings>Fit quick drain sumps* task.

Pre-Paint>Wings>Mount flaps

Objectives of this task:

In this task each flap will be positioned and the flap brackets will be glassed onto the wing.

The flaps are designed to stow in the flap recess at the rear of the wing with the front upper surface of the flap fitting snugly under the lip at the top of the flap recess as shown **arrowed** in the drawing at right.

In order to achieve an aerodynamic fit the top rear of the wing must be carefully prepared before the flap can be positioned and the flap brackets glassed into place.

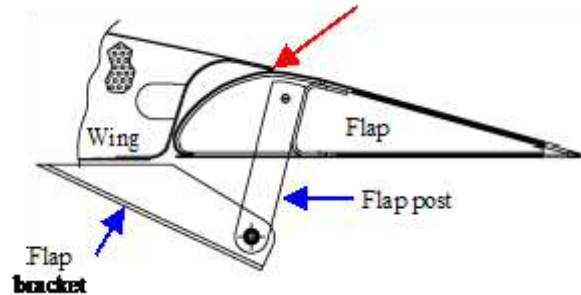

Flap mounting is a **critical** issue that can affect the aerodynamic efficiency of the wing as well as general flight characteristics and considerable care must be taken with this task.

This is probably the single most important task in the Manual!

Materials required:

Card # J16 'Electric Flaps'

Glass fibre cloth bag labelled 'Hollow Wing', Epoxy resin and flock

Prepare the wing

Turn the wing upside down and pack under the trailing edge so that the wing is stable.

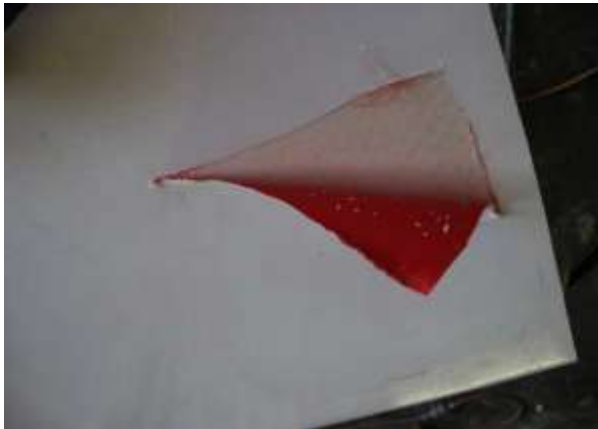

There are 4 squares of peel cloth under the gel coat at the trailing edge of the wing where the flap brackets will be located – carefully cut one corner then lift and remove the peel cloth from each area then lightly sand the area under the peel cloth.

The rear of the wing as supplied should be a uniform distance back from the rear of the flap recess. The photo at right shows the workshop tool that we use to check the depth and a line (in black, near the edge) that has just been marked.

If your wings have a black line like this marked along the rear of the underside of the wing then you should trim carefully to that line before starting on the next step.

Note that the wing is upside down in all photos in this task.

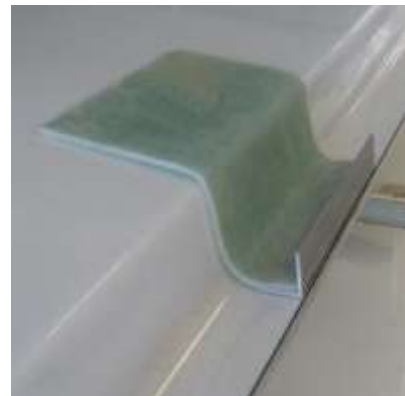

Position the flap

The flap is positioned in 3 stages:



Initial flap position: lay 2 lengths of aluminium angle on the wing surface between the outer peel cloth squares and fix to the forward part of the wing with cloth tape as shown above.

Place the front of the flap onto the lip at the trailing edge of the wing and clip the trailing edge of the flap to the aluminium angle with spring clips (circled in yellow above).



Lateral flap position: the intention now is to position the flap so that the distance from the centreline of the wing mounting bolt holes to the first rib of the flap will be 8mm.

In the factory we use a method that entails measuring the distance from the centre of the wing mounting bolt hole to the outside of the wing mounting lug, then adding 8mm to that distance, which gives us the distance that the first rib of the flap must be from a ruler or straightedge held against the wing mounting lugs.

Move the flap gently until you are satisfied that the distance from the centreline of the wing mounting bolt hole to the first rib of the flap is exactly 8mm. When that position is correct mark the wing and the flap with 2 ruled lines fore and aft over the gap between the flap and the wing (use a marker pen) so that you can easily realign the flap to the wing.



Flap to wing spacing: tape 6 pairs of mixing sticks together. Place 1 pair into each end of the gap between the flap and the wing (green arrow above right) and 1 pair under the aluminium angle on each side of the flap to wing gap (blue arrows above right) to create the required curve to the underside of the wing as shown above left. Check that the flap is pushed forwards until the pairs of mixing sticks are being held firmly in place.

Match the flap to the wing

Look under the wing at the point where the flap touches the trailing edge of the wing: the objective in this step is to fit the trailing edge of the wing to exactly match the flap, so mark the trailing edge of the wing where the flap touches and then carefully grind the trailing edge away until the flap sits snugly into the wing recess. Shaping should be done with a long sanding block: all shaping should be gentle in contour.



Leave the *rear* of the trailing edge of the wing straight and concentrate on shaping the *underside* of the lip (which is currently on top because the wing is upside down) on the trailing edge where the flap fits to an angle of approximately 30 degrees as shown above right (the angle has been emphasised with **red** lines in the photo) – this will allow the flap to retract and seat snugly under the lip with virtually no gap.

Shaping of the trailing edge will require several adjustments and each time the flap must be realigned onto the wing, using the marks that you made earlier, and the areas to be shaped are marked and then the flap is removed and the trailing edge of the wing is sanded to suit.

Take your time and get each flap *exactly* right: effort applied at this stage will be repaid in flying pleasure later.

When the angle shaping is finished use a straightedge to do a final check of the rear of the wing (which should be absolutely straight), while the angled underside of the trailing edge of the wing will be a precise match to the shape of the flap.



Prepare to flock the flap brackets

Position the flap onto the wing again. Place some very thin spacers (paint thickness, or about 0.2mm) between the top of the flap and the lip at the rear of the trailing edge. Reset the lateral flap position and refit the mixing stick spacers as described at the top of the previous page. Be *very* particular about the flap positioning at this time because you are about to mount the flaps permanently, and once they are mounted it will be extremely difficult to make any changes without causing considerable damage!



Remove the peel cloth from the outside and the inside of the flap brackets. Lightly sand the inside and outside of each bracket.

Lightly sand the entire peel cloth area where each bracket will be mounted to ensure a good bond.

Using regular brown packing tape, gently tape over the gap between the flap and the wing as shown at right to prevent any flock from entering the gap. Take care not to move the flap in any direction!

Check that the mixer stick spacers are still correctly positioned.



Place a bush in each flap post and carefully sand off the sharp edges from the rounded end of each flap post (circled at right).

Cut the glass fibre cloth from the bag marked 'Hollow Wing' as marked – cut slightly outside the marked area.

There will be 3 pieces of glass fibre cloth for each flap bracket. Lay them on the wing in front of each flap bracket position.



Make a final check of the flap alignment and make any final adjustments that may be required: remember, this next step will be almost impossible to undo so be absolutely sure that the flap is correctly aligned before moving on to the next step.

Fit the flap brackets

In this step the flap brackets will be flocked into place and then covered with 3 layers of glass fibre cloth. This all needs to be completed in the one continuous operation. In our factory this step takes over an hour with an experienced person, so allow perhaps 2 hours or slightly more.



Mix a batch of resin and coat the inside of the flap brackets and the wing surface where the flap brackets will be attached. Mix a small separate firm batch of flock and fill the inside of the angled end of the flap brackets as shown above right.



Place each bracket: holding the bracket clear of the wing, insert the bolt through the bracket and the bush, then let the bracket rotate down to the wing. Do this for each bracket.

At this point recheck the marker pen mark across the wing and flap to be sure that nothing has moved.

Once all four brackets have been placed apply a gentle downward pressure to seat each one and then round off any excess flock around the base of each bracket to an even contour with the rounded end of a mixing stick. This rounded contour will help to avoid air bubbles when you apply the glass fibre cloth in the next step.



Working on one bracket at a time, wet an area around each bracket that is slightly wider than a piece of the glass fibre cloth that you cut out in the “*Prepare to flock the flap brackets*” step above, then place a piece of glass fibre cloth onto the bracket and brush it on, working down the sides of the bracket and onto the wing, taking care to brush out any air bubbles and paying particular attention to the curved flock join between the bracket and the wing.

Repeat this process for each of the 3 layers.

Note that the first layer should be slightly ‘wetter’ than the following 2 layers.

The photos above show the second layer being applied.

There will be some excess cloth that will cover the brown packing tape – this will be cut off after the resin has cured.

Leave overnight to cure.



Next day heat the excess cloth along the wing-to-flap gap and cut it away carefully with a sharp knife.

Remove the brown packing tape and clean away any excess fibre and flock.

Remove the flap from the wing, taking care to save the pivot bushes and bolts, and store for later painting.

Check the slot size

At this point you have mounted the flap to the wing with the flap upper surface correctly aligned in relation to the trailing edge of the wing. Now the slot size – the gap between the trailing edge of the wing and the leading edge of the flap – must be checked.

The slot size is very important – when the flap is extended the airflow through the slot provides control of the airflow velocity over the flap, and thus the slot or gap size must be identical along the width of the flap or there could be a rolling moment when the flaps are extended.

To check this, turn the wing right side up and fit the flap, taking care to fit the bush before each bolt.

Deflect each flap to as close to 39.5° as you can and hold the flap in that position at each end with cloth tape.

Now measure the slot size at each flap post as shown in the drawing at right: the slot size should be as shown, but the critical measurement is that the slot size should be the *same* across the full width of the flap and the slot size should be the same for both wings at the same flap deflection.

If you have been careful in the initial flap alignment the slot size should fall within the acceptable tolerance range, but if you need to make adjustments then they should only be minor and these adjustments should be made with a long straight sanding block, starting by *slightly* altering the angled under-face of the trailing edge of the wing and *only if necessary* then altering the trailing edge of the wing itself.

Final adjustments will be made in the *Testing>Flight testing* task.

This completes the *Pre-Paint>Wings>Mount flaps* task.

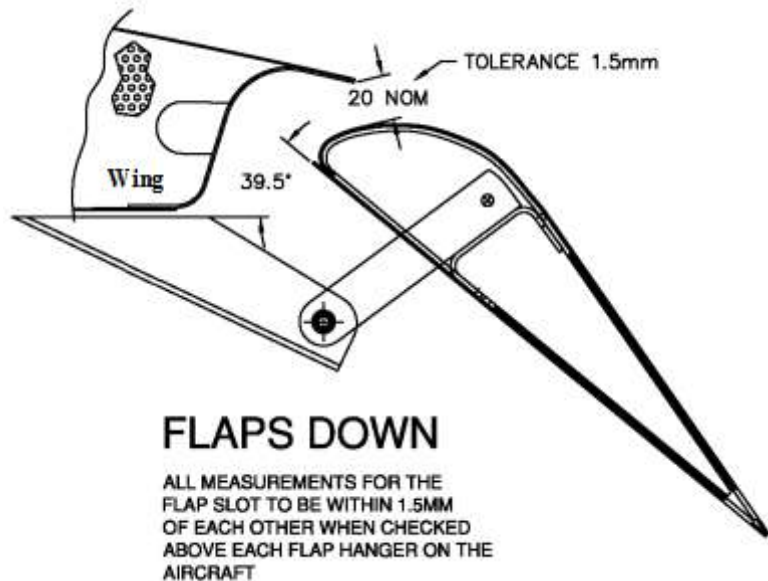

Pre-Paint > Wings > Fit wing tips

Materials required:

Epoxy resin and flock

Fit the wing tips

If you intend to fit strobe lights to the wingtips, drill a hole in the wing root and use a long rod to route the strobe wiring along behind the leading edge and out of the wing root. The wiring will need to be routed out through the strobe mount before fitting the wingtips.

Pre-fit the wing tip to the end of the wing and make sure that the wing tip sits firmly inside the wing and that the leading edge of the wing tip is level with the leading edge of the wing.

Make adjustments as required – some material may need to be removed from the joggle in order to clear the end of the spar (circled in the top photo below).

The wing tip should fit in hard against the joggle step.



Hold the wing tip in position and fix in place with 6G self-tapping screws, then remove the wing tip. Remove the peel cloth from the wing tip and sand the surfaces to be joined.

Mix a batch of resin and coat the surfaces then add flock to the remainder. Apply a 2mm layer of flock to the wing tip and fit the wing tip into place: hold the wing tip slightly closed as you place it over the end of the wing and then let the wing tip expand into the wing so that the flock is not pushed out ahead of the wing tip. Fix in place with the 6G self-tapping screws.

Wipe away any excess flock with a clean mixing stick and leave overnight to cure.

Leave to cure overnight and then remove the screws. The screw holes will be filled later as part of the *Pre-Paint preparation* task.



Fit the strobes (optional)

Should you elect to fit strobe lights to the wingtips you will find a shaped fibreglass strobe mounting base in with the strobe packing. Decide exactly where you want the strobe to fit and in what position, and then shape the underside of the strobe mount so that it will fit in the desired location and fix it in position with flock and hold it with 2 self-tapping screws until the flock has cured.

You will then need to route the wires out through the strobe base *before* fitting the wingtip.

This completes the *Pre-Paint>Wings>Fit wing tips* task.

Pre-Paint>Wings>Fit ailerons

Objectives of this task:

In this task the ailerons and the pre-mould strips will be sized and trimmed, then flocked onto the wings and glassed in place, and the next day the ailerons will be fitted to the wings.

Materials and equipment required:

Card # J5 “Aileron” for the hinges

Epoxy resin and flock

Length of flat timber 150m x 1250mm, one side covered in brown packing tape

Pavers or half bricks for weights to hold the pre-mould strip in place while the flock cures

Size the ailerons and pre-mould strips

For this step you will need to work on both wings together.

Mount the flaps temporarily with just the bolts and spacers, holding them in the fully retracted position with strips of tape over the top of the flap onto the wings.

Check the distance from the inside of the wing tip to the outboard end of the flap: the distance should be very close to equal for both wings, and in the range of 1215mm to 1220mm. If the distance is not equal for each wing then it may be necessary to trim the end of one flap slightly, but check the aileron lengths first.

With each wing right side up, lay the aileron in place on the wing and use a ruler or straightedge to line the aileron drive arm up with the aileron cable slot that was cut previously in the *Pre-Paint>Wings>Cut aileron cable inspection opening* task. The drive arm should very slightly (~1-2mm max) overlap the slot.

With the aileron held in this position mark the outboard end of the aileron where it touches the wing tip/winglet and mark the inboard end where it touches the flap.

Repeat the process with the other aileron on the other wing. Both ailerons should now be marked to an equal length in the range of 1215mm to 1220mm, ideally 1218mm

overall, with the aileron drive arms both located either outboard or inboard of the slot.

At this point if the aileron or flap needs to be trimmed then you can make adjustments as required to equalise the length, mark carefully and trim with a hacksaw or jigsaw and sand to a smooth finish. Take care to make accurate cuts that exactly match the adjoining surface.

At this stage each aileron should fit snugly into the gap between the wing tip and the flap with very little or no clearance at each end: when the ailerons have been finally fitted into place then the finished clearance can be adjusted with a sanding block.

Now cut the ends of the pre-mould strip so that it fits snugly between the wing tip and the flap. You may need to trim the lower outboard end of the curved “T” rib slightly.

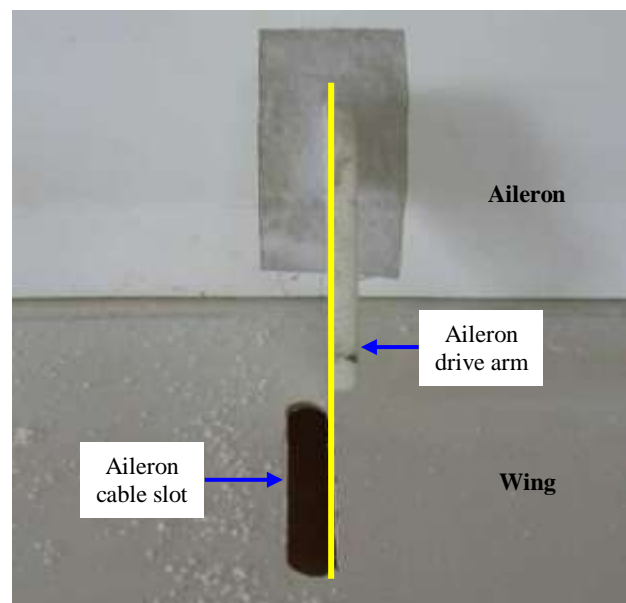

Prepare and fit the pre-mould strip

Turn the wing upside down and wedge the wing so that the top surface is level and solid.



Remove the peel cloth from the pre-mould strip (front of the flat part and both sides of the curved rib) and sand lightly. Remove the peel cloth from the wing recess in front of the aileron and sand carefully. Remove all dust from the area.

Protect the outboard end of the flap from any excess resin or flock by covering it in brown packing tape. For each wing, mix a 280g batch of resin, and divide into a 240g batch and a 40g batch. Add flock to the 240g batch of resin and mix it in thoroughly.



Apply a layer of flock to the recess on the wing – the layer should be around 3 to 5mm above the level of the wing.

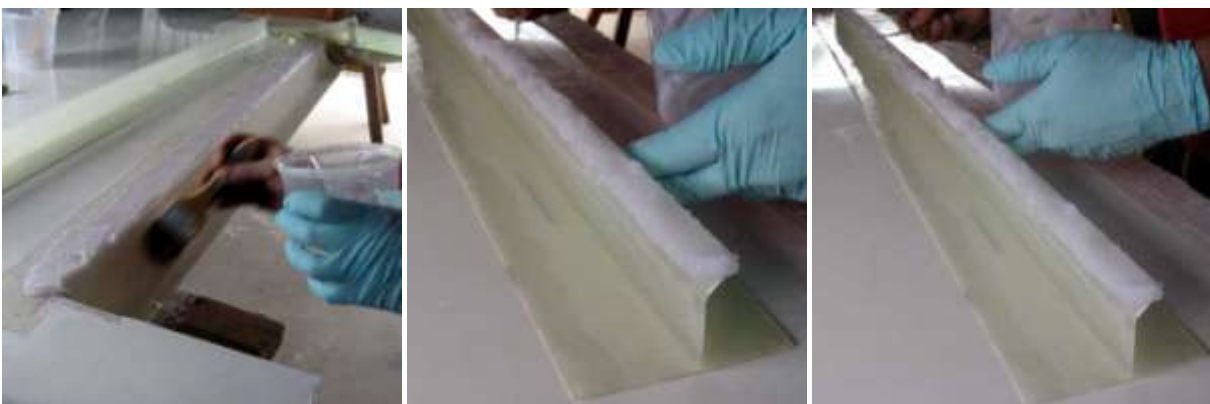

Using the 40g batch of resin, coat the curved part of the wing and the front of the curved rib on the pre-mould strip, then apply a D-shaped layer of flock to the bottom of the curved rib – the layer should be as wide as the bottom of the curve and about 10mm deep.



Fit the pre-mould strip into place – position carefully slightly above the final location and then press gently forwards and then down into place. Wipe away any excess flock.



Place the tape-covered board on top of the pre-mould strip and weight with several paving blocks or half-bricks. Wipe away any excess flock along the bottom of the curved rib, then brush on 3 layers of glass fibre cloth around the gap at the wing tip end of the pre-mould strip as circled in the photo at above right.



Apply a coat of resin to the back of the curved rib/wing join and lay in a single length of glass fibre cloth (from the Wing bag). The lower edge should be slightly in from the trailing edge of the wing. Brush the layer in carefully taking care to avoid any bubbles or gaps.

Leave the wing/pre-mould assembly for 24 hours to cure before continuing with this task.

Check and cut the aileron recess

Next day turn the wing right side up.

Lay the aileron on top of the wing and align the rear edge of the aileron with the rear edge of the flap and the rear edge of the wing tip/winglet and check that the pre-marked aileron recess on the top of the wing is parallel to the front edge of the aileron.

Make any required corrections to the markings.

Put the aileron to one side and cut out the recess with a jigsaw, then sand to a smooth finish with a long sanding block.



Fit the aileron

Turn the wing upside down again and wedge the wing so that the top surface is level and solid.

Fit the aileron in place and clip the trailing edge of the aileron the flap and the wing tip/winglet. The front edge of the aileron should be sitting on top of the pre-mould strip.



Check that the trailing edges are lined up correctly and then mark the pre-mould strip along the front edge of the aileron with a felt marker pen.

Remove the aileron and cut along the marked line with a jigsaw then sand to a smooth finish with a long sanding block.

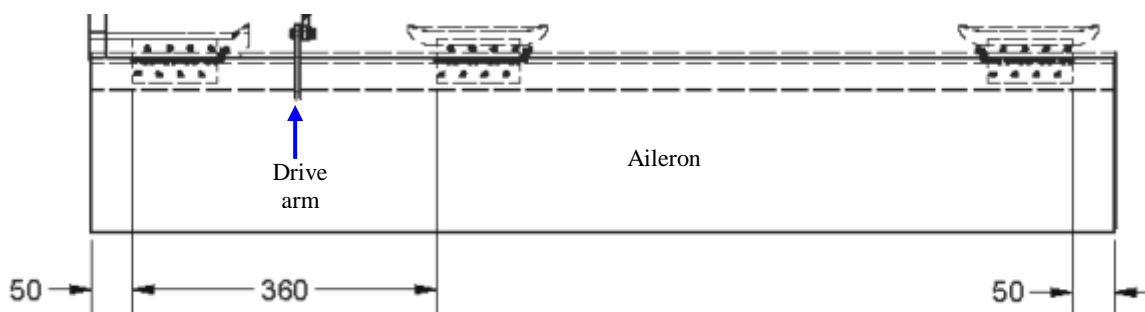

Refit the aileron and align the trailing edges again.

There are 3 hinges per aileron: 1 at each end of the aileron and 1 inside of the drive arm.

Mark the hinge locations – the outside of the end hinges should be 50mm in from each end of the aileron and the distance from the end of the aileron to the nearside of the inner drive arm hinge should be 360mm as shown above.

Mark each hinge location and identify both sides of each hinge: Hinge “A”, Hinge “B”, etc.



Place the aileron hinges in those locations with the flat side of each hinge facing upwards and the hinge pin aligned in the centre of the ~1mm gap between the aileron and the wing.

Do **not** place the hinge flat side down – if you do then the holes will not line up correctly when you come to fit the hinge.

Use a 3/32" drill to make a pilot hole opposite the pin side of each rivet hole, check that the hinge and hole positioning is correct and then carefully expand to 3/16" holes.

Test fit each hinge with 4 Clecoes and fit the hinge pin into place as shown above. Each hinge pin is inserted from the inside towards the outside of each hinge. Mark the location of the end of each hinge pin (circled at above right). Number each hinge and its location.

Check that the aileron to pre-mould strip gap is even along the full length then remove the aileron and hinges.

Sand the flat side of each hinge and the locations where they will be fitted, then mix a small batch of resin and coat each area. Add flock to the remaining resin and apply a 2mm layer of flock to each hinge and flock into place using clean Clecoes in the outer holes as before.



Using a 120° countersink bit carefully countersink the 4 inner holes just enough so that a countersunk rivet head will sit flush with the surface when fitted and rivet the 4 inner holes with countersunk rivets. Now remove the Clecoes from the outside holes one at a time, countersink each hole and fit a countersunk rivet until each hinge has 8 countersunk rivets.

Take care to keep flock away from the hinge pins during this step: clean the hinges while the flock is still wet then leave both parts (wing and aileron) separate and leave overnight to cure, then store the ailerons for later painting. Clean the Clecoes in acetone after use.

Next day use a rat tail file to make a slot into the wing at each hinge pin mark (example circled at above right), fit the hinge pin and the hinge pin retainer, mark the retainer screw hole and drill a 3/32" hole. Pop rivet a captive nut under each retaining screw hole using 2 3/32" countersunk rivets.

Fit the hinge gussets

Turn the wing right side up for this final step.

The hinge gussets provide strength and prevent flexing of the pre-mould strip around the aileron hinges. Each hinge will have a gusset flocked in place at each side.

Cut 6 gussets per wing (for a total of 12 gussets) and fit each gusset to the pre-mould strip as shown in the drawing at right:

Each gusset will need to be sanded to a good fit, then flock one gusset in place at each side of each hinge – refer to the photo below for an example of gusset placement.

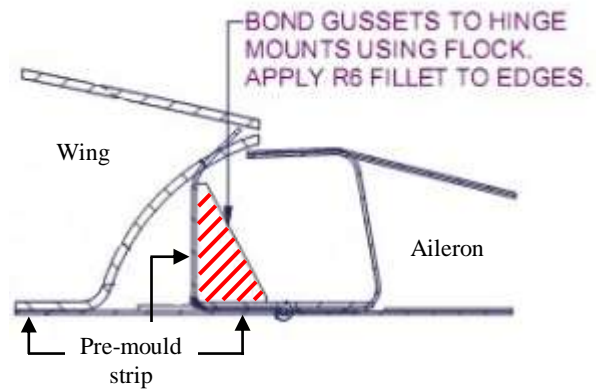

Position each gusset carefully into place on a bed of flock, then use a clean mixing stick dipped in resin to round the flock off to a smooth R6 fillet.

An R6 fillet is about a “finger wipe” radius. Do not wipe away any more flock or the load will not be transferred correctly and the gusset may break away in use.



The photo above shows a typical gusset fitting.

Leave the gussets overnight to cure.

This completes the *Pre-Paint > Wings > Fit ailerons* task.

Pre-Paint > Wings > Fit pitot tube to strut

Objectives of this task:

To fit the Pitot head and tube to the right-hand strut prior to painting.

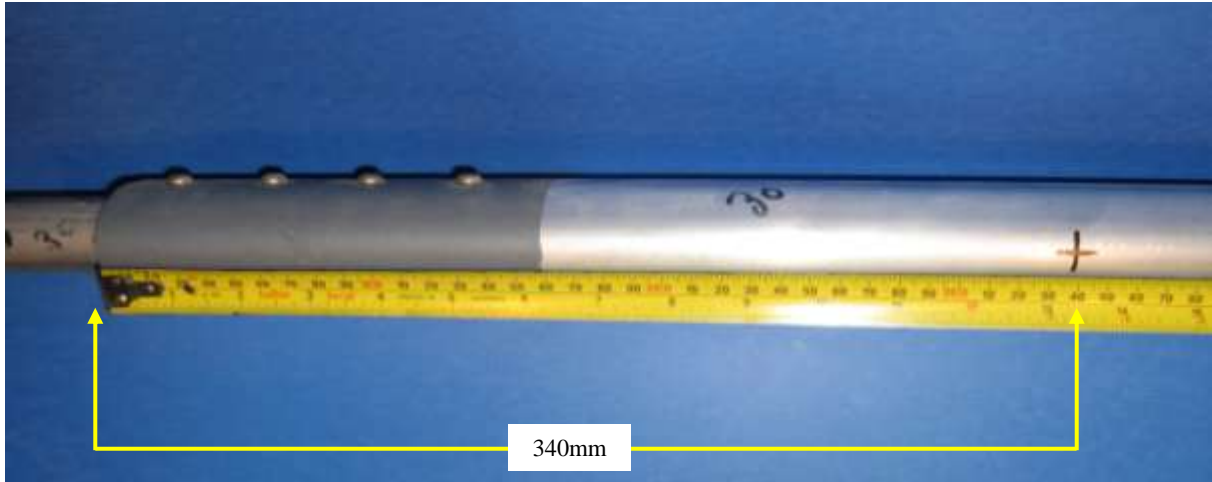

Take the right hand strut and measure down 340mm from the upper/wing end of the airfoil-shaped section, mark and drill a 10mm hole in the front of the strut.



Feed the supplied 1/4" ID plastic tubing into the hole and down the strut until it can be seen at the bottom, then fit the top end of the tube over the pitot fitting and superglue and lock wire the tube in place as shown at right.

Feed all the tube into the strut until the pitot head mounting plate sits against the strut then pop rivet the plate in place as shown in the photo below.

Refer the drawing on the next page for details.

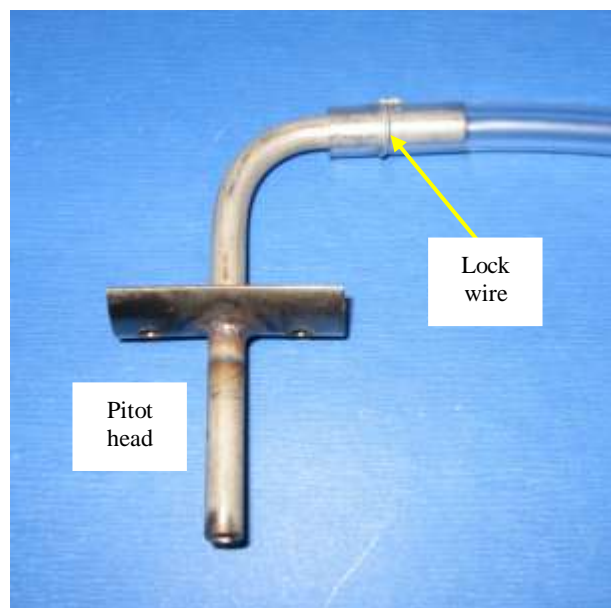
Tie the excess plastic tube to the outside of the strut and set the strut aside for test fitting and painting.

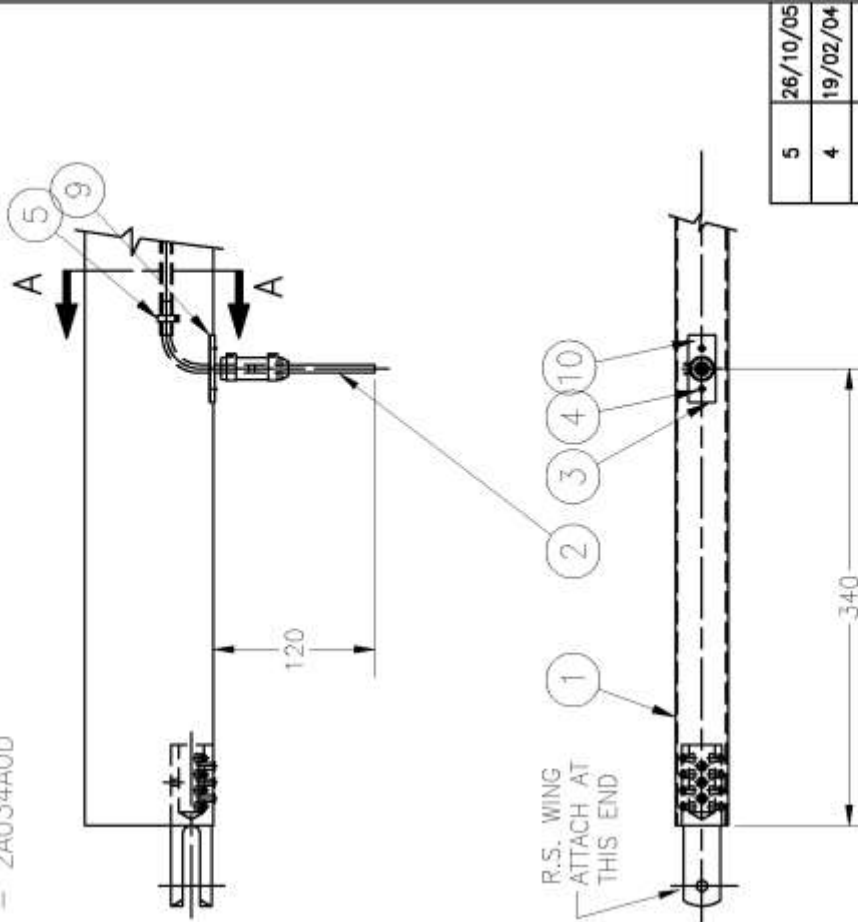

<p>THIS DRAWING IS COPYRIGHT AND MUST NOT BE COPIED WITHOUT CONSENT OF AVTECH PTY LTD</p>	<p>PROJECTION</p> 	<p>DO NOT SCALE</p>	<p>MILIMETRES</p>	<p>5. J160 - 2A030A0D 6. J170 - 2A034A0D</p>	<p>SCALE</p> <p>1:5</p>	<p>ISS. DATE</p> <table border="1" style="margin-left: auto; margin-right: auto;"> <tr><td>5</td><td>26/10/05</td></tr> <tr><td>4</td><td>19/02/04</td></tr> <tr><td>3</td><td>000107</td></tr> <tr><td>2</td><td>060993</td></tr> <tr><td>1</td><td>280991</td></tr> </table>	5	26/10/05	4	19/02/04	3	000107	2	060993	1	280991																																		
5	26/10/05																																																	
4	19/02/04																																																	
3	000107																																																	
2	060993																																																	
1	280991																																																	
<p>NOTE WING STRUT P/No.'s:</p> <p>1. SHORT WING - 2A002A0D 2. LONG WING - 2A003A0D 3. J SHORT WING - 2141023 4. J 250/450, J230/430 - 2A004A0D</p>				<p>SCALE 1:5</p>																																														
<p>SECTION AA</p> 				<p>R.S. WING ATTACH AT THIS END</p> 																																														
<table border="1" style="width:100%; border-collapse: collapse;"> <thead> <tr> <th>ITEM</th> <th>PART No.</th> <th>DESCRIPTION</th> <th>QTY.</th> </tr> </thead> <tbody> <tr><td>10</td><td>5044494</td><td>PITOT MOUNT W/A</td><td>1</td></tr> <tr><td>9</td><td>504439N</td><td>TUBE BENT PITOT</td><td>1</td></tr> <tr><td>8</td><td>????</td><td>HOSE CLAMP *MS8242</td><td>2</td></tr> <tr><td>7</td><td>504439N</td><td>HOSE COUPLING</td><td>1</td></tr> <tr><td>6</td><td>PV0029N</td><td>PVC TUBE 1/4" ID</td><td>1</td></tr> <tr><td>5</td><td>PI0139N</td><td>WIRE TIE</td><td>1</td></tr> <tr><td>4</td><td>PH0029N</td><td>RIVET</td><td>2</td></tr> <tr><td>3</td><td>504429N</td><td>MOUNT PLATE PITOT TUBE</td><td>1</td></tr> <tr><td>2</td><td>504419N</td><td>TUBE STRAIGHT PITOT</td><td>1</td></tr> <tr><td>1</td><td>SEE NOTE</td><td>WING STRUT ASSY</td><td>1</td></tr> </tbody> </table>				ITEM	PART No.	DESCRIPTION	QTY.	10	5044494	PITOT MOUNT W/A	1	9	504439N	TUBE BENT PITOT	1	8	????	HOSE CLAMP *MS8242	2	7	504439N	HOSE COUPLING	1	6	PV0029N	PVC TUBE 1/4" ID	1	5	PI0139N	WIRE TIE	1	4	PH0029N	RIVET	2	3	504429N	MOUNT PLATE PITOT TUBE	1	2	504419N	TUBE STRAIGHT PITOT	1	1	SEE NOTE	WING STRUT ASSY	1	<p>TITLE</p> <p>PITOT ASSY - OMNIBUS DRAWING</p>		
ITEM	PART No.	DESCRIPTION	QTY.																																															
10	5044494	PITOT MOUNT W/A	1																																															
9	504439N	TUBE BENT PITOT	1																																															
8	????	HOSE CLAMP *MS8242	2																																															
7	504439N	HOSE COUPLING	1																																															
6	PV0029N	PVC TUBE 1/4" ID	1																																															
5	PI0139N	WIRE TIE	1																																															
4	PH0029N	RIVET	2																																															
3	504429N	MOUNT PLATE PITOT TUBE	1																																															
2	504419N	TUBE STRAIGHT PITOT	1																																															
1	SEE NOTE	WING STRUT ASSY	1																																															
<p>LIMITS +/- 1</p>				<p>DWG. NO. 9024094-5</p>																																														
<p>MATERIAL AS DETAILED</p>				<p>SHEET 1 OF 1</p>																																														
<p>AVTECH P/L A.C.N. 010 786 973 HINKLER AIRPORT BUNDABERG</p>				<p>PITOT ASSY - OMNIBUS DRAWING</p>																																														
<p>DRAWN JW</p>				<p>SCALE 1:5</p>																																														
<p>APPR.</p>				<p>DATE</p>																																														

This completes the *Pre-Paint > Wings > Fit pitot tube to strut* task.



Pre-Paint>Wings>Test fit wings

Objectives of this task:

To test fit the wings and flaps to the fuselage prior to painting. This task is intended purely to make sure of the fit and to make any adjustments that may be required so that there will be no issues during the final fit after the wings and fuselage have been painted.

Each wing will be held in place with 4 bolts in this task and no nuts will be used – this is purely a test fit task after which the wings will be removed and prepared for painting.

In our factory we use 3 people for this task, so ask 2 friends over to help you.

Do **not** try to do this task with less than 3 people or you risk dropping the wing.

While the wings are in place the strut to wing fairings will be fitted and the strut/main gear to fuselage fairings will be pre-fitted and then removed for painting.

Equipment required

2x4” timber for wing support – see the 3rd page of this task for details

Preparation

Place 2 trestles beside the fuselage and lay the wing on them.

It is **very important** that the AN4-14A wing attach bolts fit snugly through the holes in the attach bushes on the wing and the aluminium wing attach lugs on the fuselage. Test fit a bolt in each hole, and if the bolt will not fit through to full depth then **very carefully** ream the holes with a hand reamer out until the bolts fit correctly.

It is also **very important** that the AN175-15A strut attach bolts fit snugly through the holes in the strut attach lug under the wing, the lower fuselage mount and the top and bottom holes in the strut itself. Test fit a bolt in each hole, and if the bolt will not fit through to full depth then **very carefully** ream the holes with a hand reamer out until the bolts fit correctly.

Do not ream any more than is absolutely necessary to get a snug fit, and **do not** use a drill in place of a reamer!

These are **critical fit** items and great care must be taken!

Using a sanding block, lightly sand both sides of each wing attach lug and the upper and lower strut mounts to clean any debris away.

Fit the bottom of the strut to the lower fuselage mount with an AN175-15A bolt. Rest the outboard end of the strut against a saw stool as shown at right.

Lay 2 AN4-14A wing attach bolts on top of the fuselage where you can easily reach them.

Now you are ready to test fit the wings.



Test fit the wing

Because the precise alignment of the wing bolts is **critical** the bushes in the wing attach lugs in the wing root that the bolts pass through are mounted in a bed of flock to allow for fine adjustment during fitting.



The process that we use in our factory is to get the wing prepared and ready to fit, then heat up the wing root bushes and fit the wing. Heating of the bushes is done by placing a soldering iron in each bush as shown above and waiting until the other side of the bush is too hot to touch comfortably. This gives 3 or 4 minutes working time, which is usually enough.



One person holds the outboard end of the wing while the other 2 hold the front and back of the wing root. Walk the wing in to the fuselage and guide the wing attach lugs into the aluminium wing attach brackets on the fuselage. The fit will be tight and it may take some careful positioning of the wing to get them to fit – the outboard end of the wing may need to be moved forward or backwards to get the correct alignment. As soon as one bolt can be fitted though then do so and then that bolt can be used as a pivot to work the other lug into place.

The wing attach bolts are fed in from the front and back of the wing toward the centre of the wing.

The fit of the bolts will be tight and you will have to tap the bolts into place using a soft hammer and a brass drift/punch. Be careful and resist any temptation to tap the bolt too hard but rather **gently** encourage each bolt to pass through the bracket and the wing bush.

While the wing is being fitted the strut mount bush under the wing can be heated by the same method so that it will be ready. Once both wing root bolts are in place the top of the strut can be fitted to the strut mount and the wing is fitted.

The important thing at this stage is to relieve the weight of the wing while the flock cools and sets in the correctly aligned position, and this is done by lifting the outboard end of the wing up about 35mm from the resting position and supporting it overnight.

We use a simple wooden support for this (pictured at right) but an even simpler “T” shape of 2x4 timber cut to length would be fine. Leave the wing undisturbed overnight and the next day the support can be removed and the other wing fitted in exactly the same way.

Once both wings and the flaps and strut fairings have all been satisfactorily test fitted the wings can be removed and set aside for painting.



Test fit the flaps

We use 2 people in the factory to carry out this step and we recommend that you do the same, as the flap is too long for one person to handle comfortably and safely.

Flap fitting

Each flap post bolt hole has a short length of Bundy tube spacer fitted inside (*tip*: a smear of grease will hold the spacer in place while fitting) and each post fits into each flap hanger and is held in place with an AN3 bolt.

Size the inboard end of the flap

The inboard end of each flap is manufactured slightly over length to allow for variations in flap hanger placement and it will now require trimming to allow it to clear the fuselage at full deflection.

Ideally the flap should clear the fuselage by a small amount, nominally 5mm, when at full deflection. Full deflection in this case is defined as being 40° from the fully retracted position.

The first step is to hold the flap in place and check for overall length with the flap in the fully retracted position, then manually lower the flap by hand in stages until the end of the flap touches the side of the fuselage. Take care that you do not scratch the rear window.

Working in small stages, mark and trim the end of the flap until the flap can be lowered to the full deflection position without touching the fuselage. In the factory we find that the use of a marker pen held flat against the fuselage to mark the underside of the flap at each stage can be quite useful. A jigsaw is used to trim the flap.

Remember that the top of the flap will not be trimmed quite as much as the bottom of the flap due to the shape of the fuselage at this location.

Work slowly and in stages until the flaps clear the fuselage by 5mm at full deflection.

When you are satisfied that the inboard end of each flap is correctly cut and shaped, use a long sanding block to smooth off the cut surfaces.

Fit the strut to wing fairing

While the wing and strut are fitted the strut to wing fairing can be fitted and the back half of the fairing can be flocked into place on the wing.

Assemble each fairing on the bench – fit the front section over the joggle on the back section and fit the 2 halves together with 4 x 6G stainless steel self-tapping screws on the outside and 1 screw on the inside and then take them apart again. Refer to the photo at right for the outside screw placement.

Now reassemble each fairing around the strut and locate the fairing on the wing: carefully centre the assembled fairing on the strut so that there is an even gap all around the strut and make sure that the fairing is lined up fore and aft.

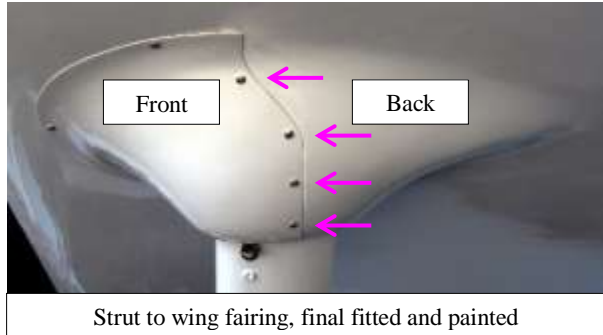

Mark around the back half of the fairing and tape it into place, then drill 6 evenly spaced holes through the mounting lip of the fairing and through the surface of the wing. **Do not** drill any deeper than 5mm or you risk hitting the fuel tank! Fix the back half in place with a few 6G stainless steel self-tapping screws, then remove the screws and lower the fairing.

Repeat the process on the other wing.

Prepare the surfaces to be bonded: sand both surfaces and ensure that they are clean.

Mix up a small batch of flock and flock the back half of each fairing to the wing, holding it in place with 6G stainless steel self-tapping screws. Leave overnight for the flock to cure, then next day remove the screws – use a soldering iron if necessary to loosen the screws in the flock.

The join between the fairing and the wing will be filled and finished in the *Painting* task.

Pre-fit the strut/main gear to fuselage fairing

The strut/main gear fairing comes in 2 sections (left and right) and it covers the strut to fuselage join, the main gear to fuselage join and also fairs the main gear mounting recess.



Right hand side strut/main gear fairing from below (top photo) and side on (above)

Fit the right hand section first: fit the fairing into place and hold it there temporarily with some cloth tape, then fit the left hand section of the fairing and tape it into place also and check all round each half of the fairing and adjust as required for the best fit. When the fit is correct all round drill 5/32" holes around each fairing and the fuselage in the pattern shown in the photos above.

Remove the fairings and enlarge each fuselage hole to 13/64" and tap each hole to a 1/4" UNC thread. Each hole will have a threaded insert (shown circled at right) recessed, screwed and super-glued into it, using the screw and spacer (also pictured) to drive the insert home in exactly the same manner as the *Ventral Fin* in the *Pre-Paint>Fuselage>Fit ventral fin and trim horn* task.



This completes the *Pre-Paint>Wings>Test fit wings* task.

Paint>General

Objectives of this task:

To paint the aircraft, which involves disassembling the fuselage, empennage and wings, then the preparation – filling, sanding, priming and so forth, and finally application of the topcoat.

Body filler adds weight to your aircraft and Q-Cell is the lightest filler available so we suggest that you use Q-Cell for the larger fills and finish off with a lightweight body filler.

Paint also adds weight to your aircraft and so we recommend that you keep the amount of paint to the minimum necessary to achieve a good finish: just enough of a light-coloured undercoat to cover filler and all of the bare spots, followed by a single topcoat.

The topcoat **must be white** for heat rejection purposes, and any coloured striping or detail can only be applied to vertical surfaces – **all horizontal surfaces must be plain white.**

Filler and paint:

In general we use automotive grade paint preparation products and automotive grade 2-pack epoxy paint. The specific brands that we use here in Australia may not be available where you live and you may have to find similar products locally.



- | | | |
|---------------------------------------|-----------|--|
| Lightweight body filler | 2 tins | “K&H Mercury” brand or similar (photo #1) |
| Spot putty | 4 tubes | “Ever-Glaze” brand or similar (photo #2) |
| 2 pack epoxy primer undercoat | 5 litres | “Protec Autofleet” brand or similar (photo #3) |
| 2 pack polythane white topcoat | 12 litres | “Protec Barrier” brand or similar (photo #4) |

Q-Cell and polyester resin lightweight body filler – a 3-part mix consisting of:

- | | | |
|------------------------|----------|---|
| Q-Cell microspheres | 1 kg | mix with resin as required, about 20% by weight |
| Polyester resin | 4 litres | |
| 40% M.E.K.P. solution | 20ml | catalyst for the polyester resin/Q-Cell mixture |
| Etching primer | 250ml | for priming metal parts: noseleg, etc |
| Wax and grease remover | 1 litre | for final washdown prior to topcoat |

Thinners, retardant, etc as required to suit the chosen products and conditions

Tack cloth – available from automotive paint suppliers, removes fine dust prior to the application of the topcoat.



Sandpaper:

Generally we recommend and use “3M” brand (or 150mm “Stickit” brand pads for a random orbital sander) aluminium oxide sandpaper in the following grades and quantities:

- First all over sand 180-grit 1 box
- Filler sand 80 and 120-grit 1 box of each
- Spot putty and final sand 240-grit 2 boxes

Equipment required:

Cork or rubber sanding blocks, flat and curved.

150mm random orbital sander, either electric or pneumatic, preferably with dust extraction.

Compressor and spray gun – we use a low-pressure pot gun (~80psi) in the factory, but follow the instructions of your chosen paint supplier.

Half-face respirator with suitable painting filters.

Disposable coveralls, gloves, boots and safety glasses or goggles.

Assorted saw stools, wire hooks and trestles will be required to support individual parts while they are being prepared and painted. In the paint booths at our factory we hang smaller parts in rows from roof-mounted rails, while wings are fitted to purpose-built supports that hold the wing root and support the outer end with a hook through the flap brackets.

Disassembly

Preparation and painting is done with the aircraft completely disassembled - all parts will be prepared and painted separately and then reassembled after the paint has cured.

We suggest that you bag all the hardware (bolts, nuts, washers, clips, etc) for each component separately and clearly label what each bag is for – this will make your life so much easier during reassembly.

Remove the ailerons and flaps from the wings, then remove the wings and wing struts.

Remove the elevator, rudder and ventral fin from the empennage.

Remove the wheel spats and any other fairings.

Remove the doors and the engine cowlings.

Remove the noseleg assembly and place a saw stool or prop under the attach point, or alternately leave the noseleg in place and mask around it.

Remove any other small items such as ventilation doors, oil door and so on.

Clean everything thoroughly

The entire aircraft should be disassembled (see above) and then everything should be blown out thoroughly with compressed air and then vacuumed out to remove dust and debris from every part of the airframe. You do not want dust being blown into the finish because it didn't get cleaned out properly beforehand.

While you are cleaning, take the time to clean out your work area too – blow and sweep all dust and rubbish from the walls, benches and floor and get into the habit of doing this at the end of every work day so that when you come to apply the paint the work area will be substantially clean to start with and you won't get any little “surprises” in the finish.

Paint>Masking

General: we recommend and use regular automotive masking tape and brown masking paper. We do **not** recommend the use of newspaper for masking due to its porous/absorbent nature.

We recommend and use “*Fine Line*” brand edging tape (photo below left) to define the edges of windscreen and windows then follow up with normal 1” wide tape and brown paper to fill.

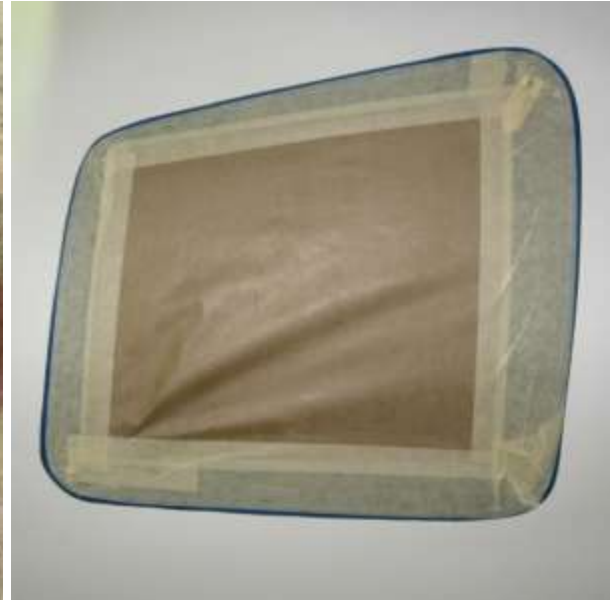

The windscreen, door and side windows will all need to be masked very carefully, paying particular attention to the shape of the masked area, which should closely match the shape of the underlying glass fibre structure. Use the “*Fine Line*” tape and mask slightly (~5mm) inside of the structure line and then use a folded piece of 240-grit paper and sand right up to the tape to provide a good key for the paint to adhere to. Take your time with this – you will see the shape of your windscreen and windows every time that you fly so make them even and pleasing to the eye. The photo above right shows a side window fully masked – note the blue “*Fine Line*” tape defining the edge and the regular masking tape and paper infill.

Do not rush the masking stage, but rather take your time and do it carefully: care at this stage will save you a lot of time and grief later – overspray is **not** easy to remove, particularly with 2-pack paint, so mask up very carefully. Overspray will sneak through the smallest gaps.

Mask all control surface hinges on both the control surface and on the adjoining structure.

Mask the VHF antenna and static tube.

Mask inside the door openings so that the door opening will be painted but overspray will not get inside the cabin and foul the inside of the windows.

Mask the engine and engine bay back to the outside edge of the firewall – wrap the entire engine and engine mounts in masking paper and seal off at the firewall.

Mask the main wheels and brakes.

Mask the suspension rubbers on the noseleg.



Masked and undercoated J170 fuselage



Paint>Surface preparation

It is true that any paint job is only as good as the preparation – shiny paint will most definitely **not** hide anything, and in fact shiny paint will only magnify any lack of preparation so surface preparation will be the most time-consuming (and ultimately rewarding) part of the painting process. If you want a slick-looking finish this is how to get it: prepare carefully!

The surface preparation process is: sand everything with 180 grit paper; fill where required (Q-Cell for larger areas and lightweight body filler for smaller areas, nicks etc); sand the filler smooth with 80 and then 120 grit paper; apply undercoat; fill pinholes and small nicks with spot putty; sand spot putty with 240 grit paper; touch up with undercoat; final sand with 240 grit paper; wash with wax and grease remover, dry off and wipe over with a tack cloth.

Wear your half face respirator all the time during the sanding and painting process – there will be a lot of fine dust generated and your lungs will thank you for it.

Lets get started!

Sand the entire surface of the aircraft and all parts to be painted with 180-grit sandpaper – we use a random orbital sander for this task and for most of the sanding in the factory. This will provide a key for filler and undercoat to bond to. Be careful not to sand through the gelcoat and into the structural glass fibre – if you do go through the gelcoat do **not** sand any deeper.

Filler is used to fill imperfections in the surface to be painted, so you will use filler for things such as filling in ripples or dents. When filling large areas we have found that the use of a very wide (~9”) spatula (make your own from plastic) provides a good finish with little waste.

Mix up a large batch of Q-Cell and polyester resin to a creamy consistency and keep it in a sealed tin: this mix will last about 5 days. Stir the Q-Cell mix thoroughly before each use and then scoop out one hand-sized amount at a time onto a flat mixing board, add 3% of M.E.K.P. catalyst/hardener and mix it in thoroughly - this will give you about 15 minutes working time - and apply with a wide spatula. Allow to cure for a few hours until it cannot be scratched with your fingernail and then sand back to a smooth finish with 80 and 120 grit paper.

Smaller areas can be filled with lightweight body filler and sanded back in the same manner.

You might find it easier to work on one area at a time when applying filler so that you don't lose track of where you are. If you decide that this way or working appeals to you, you might want to consider working on a specific area until you are happy with the finish and then undercoating that area before moving on to the next area. Working in this manner means that you are less likely to miss anything and the undercoat allows you to see where you have been.

Metal surfaces such as the noseleg must be cleaned and primed with an etching primer.

Now spot putty can be used to fill smaller imperfections such as pinholes and the like. Spot putty is applied with a spatula, left to dry and sanded back with 240-grit paper. Work your way around all surfaces in this manner and then apply undercoat to all spot puttied areas.

By now many days will have passed and all surfaces should be smooth and undercoated.

All surfaces can now be hand-sanded with 240-grit paper as the final stage in surface preparation, then all dust can be blown away and everything can be wiped down with a clean cotton cloth. Wash everything with warm water and detergent and then with automotive wax and grease remover and then allow all surfaces to dry off completely.

At this point the entire work area must be thoroughly cleaned and the floor and walls washed with water to wash away and damp down any dust.



Paint>Topcoat

This is what you have been working towards – the application of the topcoat.

This is a critical task where you only get one chance to get it right. If you are unsure of your ability to apply the topcoat then you may want to hire a professional painter – perhaps the local car painter would do the final coat for you on an hourly rate, or maybe you have a friend who is good at such things. You could even find someone who can teach you how to paint; perhaps there is an adult education facility near you who could help.

The work area should have all dust and debris removed and then be thoroughly wetted down to minimise the chance of dust settling into the final finish. Hose the floor and sweep it out.

All parts should be supported or suspended in such a way that you can paint them and leave them to dry (it might be necessary to paint the fuselage separately from the smaller parts if you are working in cramped conditions).

Ensure that you have plenty of ventilation while painting and that any air being directed over the work surface is clean air – in our paint booths we use automotive grade air filtration across the inlets to each booth with large extractor fans that vent above the booth, however you should be able to achieve a reasonable level of filtration by drawing air from openings that are above ground level and screening them with clean insect screens with muslin or similar open weave cloth placed over them. If using the prevailing breeze you may have to wait for a day when the wind is blowing in the right direction before painting, or perhaps you could use an industrial fan as an extractor fan to draw clean air over the work surface.

It bears repeating here that the topcoat **must be white** – under no circumstances must any other colour be used, and any coloured trim can only be applied to vertical surfaces: never use any colour other than white on the horizontal surfaces.

Finally all surfaces should be wiped over carefully with a new tack cloth.

It is not possible to give written instructions regarding painting technique and so all that can be written has to be this: read the directions from your chosen paint supplier very carefully and follow them to the letter. Expect to use about 4 litres for the fuselage, 4 litres on the wings and 3 litres on the remaining parts.

Mix your paint and hardener together thoroughly and in the exact ratio given in the paint manufacturers instructions, clean and lay out your air hoses so that you will not trip over them and make sure that you wear your coveralls and respirator at all times while painting.

Take your time, apply the paint in an even pattern and good luck!

Once you have finished painting leave the area and keep the ventilation system running for a few hours. Leave the paint to cure undisturbed – read the manufacturers directions for guidance on how long to wait – and resist the temptation to rest anything on the newly painted surface for at least a few days as it might make a mark in the still curing paint.

Peel the “*Fine Line*” tape back very carefully from around the windscreen and windows, taking care to peel back along the masked line, which will give you a nice clean edge.

Unmask the engine and the door openings, refit the noseleg and nose wheel and remove all other masking. In general peel masking back away from the painted surface.

Reassembly will be addressed in the next major section of this manual: *Post-Paint*.

This completes the *Painting* task.



Post-Paint>General

Objectives of this section:

This is the beginning of the *Post-Paint* section of the Constructors Manual.

At this point you should have a shiny white painted fuselage and a large number of painted aircraft parts along with boxes of upholstery, wiring and instrumentation in your workshop.

The task at hand now is to assemble all of these parts into a complete and flyable aircraft, and the sequence of assembly can make this process either enjoyable or painful depending on how you choose to proceed.

The suggested sequence that follows is exactly the same as we use in our factory and in general it involves leaving the wings off until the very last, which will save you a lot of ducking and bumps on the head. The wings have been pre-fitted at the end of *Pre-Paint* so you know that they will fit correctly, but we suggest that you forego the final fitting until last.

That beautiful shiny white paint should be left for at least 5 days to cure before starting on reassembly – fresh 2-pack paint is surprisingly vulnerable to marking until it is fully cured and such marks can be difficult to touch up, so it is far better to let all the painted surfaces sit and cure fully before starting work. Patience *will* be rewarded in this case.

During this paint curing time we suggest that you start by fitting the panel mounted throttle to the instrument panel housing and assembling and wiring up the instrument panel, all of which is done out of the aircraft on the workbench.

The assembly sequence then is to fit all of the upholstery apart from the seat covers: firewall, console, floor/sides/roof, etc, electrical wiring can then be fitted and terminated, then install all of the controls and the static and pitot systems, brake system and fuel system (all of which have all been pre-fitted during *Pre-Paint*).

The instrument panel housing is now fitted, engine control cabling is connected, the instrument panel is fitted to the housing and the seat covers are fitted.

Moving back to the empennage, the elevator and rudder are fitted and the trim system is installed, although the ventral fin will be left off until final adjustments are made.

Finally the doors and door seals can be fitted and the interior is complete.

Now we can move to complete the engine bay and fit the propeller and spinner and fit the cowlings. The front and main wheel spats are also fitted at this time.

Now that the fuselage is complete the wings can be assembled (aileron cables, ailerons and flaps) and fitted to the fuselage and the fairings are fitted. This completes Construction.

Now you are into *Testing*: rigging checks can be performed and final adjustments can be made as required. The ventral fin can now be fitted.

A weight and balance check can be conducted, then the fuel tank levels can be calibrated and then interior placards and decals can be affixed.

Registration markings and stripes are fitted at this time along with all fairings.

A thorough pre-flight checklist must now be completed and the aircraft can be prepared for a test flight.

Each of the foregoing tasks will now be described in detail.

Post-Paint>Fuselage>Fit panel mounted throttle

Objectives of this task:

To fit the panel mounted throttle linkage to the instrument panel housing.

Materials required:

Resin and flock

Card # J4 “Panel Mount Throttle”

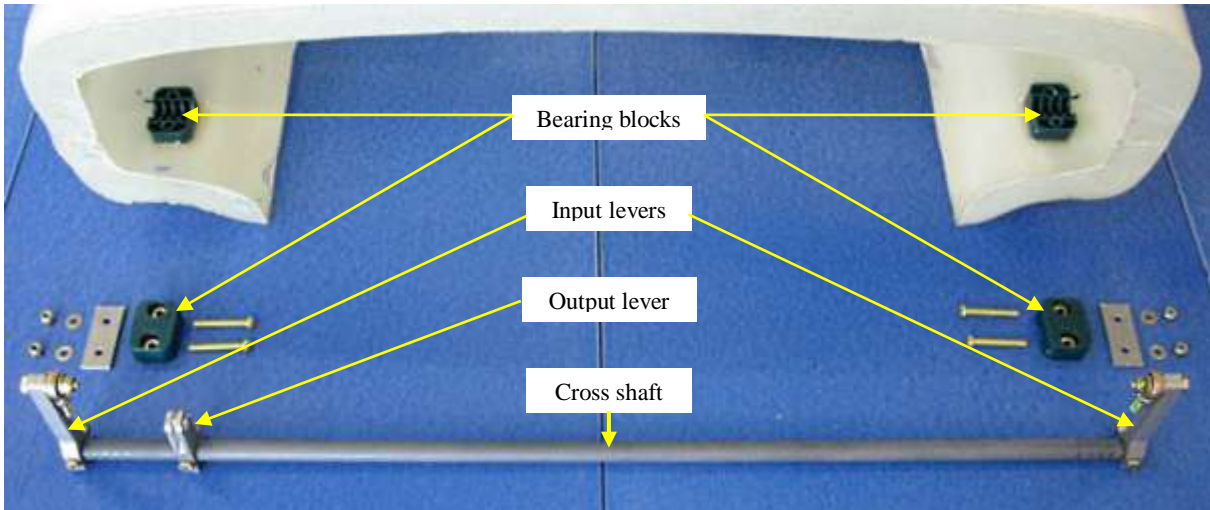

Rear view of the panel showing the bearing blocks in place and the cross shaft ready for assembly.

Fit the cross shaft bearing blocks

The throttle cross shaft is used to determine the side-to-side position for the bottom half of each bearing block, so the first task is to assemble the cross shaft as shown above.

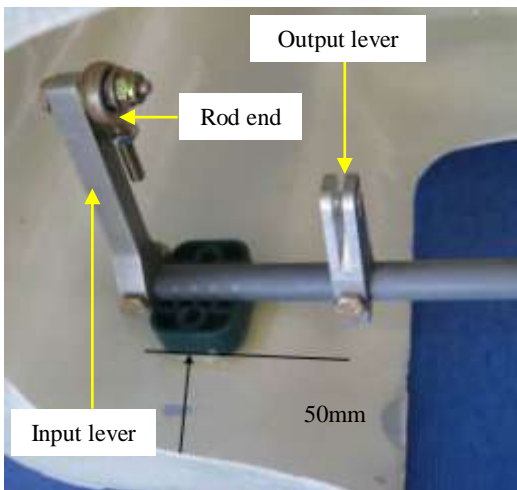

Now, working from the rear of the panel, make a mark 50mm in from the bottom of the rear lip on each side (as shown at left) and position the bottom half of each bearing block behind each mark. Sit the assembled cross shaft in each bearing block and move the bottom half of each bearing block out until the cross shaft has no side-to-side movement.

Make sure that the cross shaft is evenly spaced in from each side of the panel, then mark the position of each bearing block and flock each block in place, using the cross shaft to keep the blocks in alignment. Leave overnight to cure.

Next day run a 3/16” drill through each hole in the bearing block and drill through the panel housing, then grease the throttle cross shaft, put each bearing block cap in place and fix it to the panel housing with 3/16” screws, bearing plates (shown at right), washers and Nyloc nuts and tighten the nuts to safety.

Too much tension will make the throttle stiff to move, so test the amount of friction as you tighten the nuts.



Fit the rod ends to the inside of the input levers with AN3-8A bolts fitted through the input levers, then an AN960-416 (3/16") flat washer, then the rod end followed by an AN960-515 (1/4") flat washer and a Nyloc nut as shown in the photo on the previous page.

Fit the input shaft pivot blocks

In this step we will fit the input shaft pivot blocks to the sides of the panel housing.

With the cross shaft secured in place, put the panel housing on it's back so that the panel opening faces upwards. Screw the throttle input shafts onto the rod ends on the input levers with a drop of Loctite 242 on the threads and tighten firmly.

Temporarily fit the instrument panel to the panel housing with cloth tape, making sure that the throttle input shafts go through the correct holes in the instrument panel. Centre each throttle input shaft in its hole in the panel by using a small length of rubber hose as shown arrowed at right.

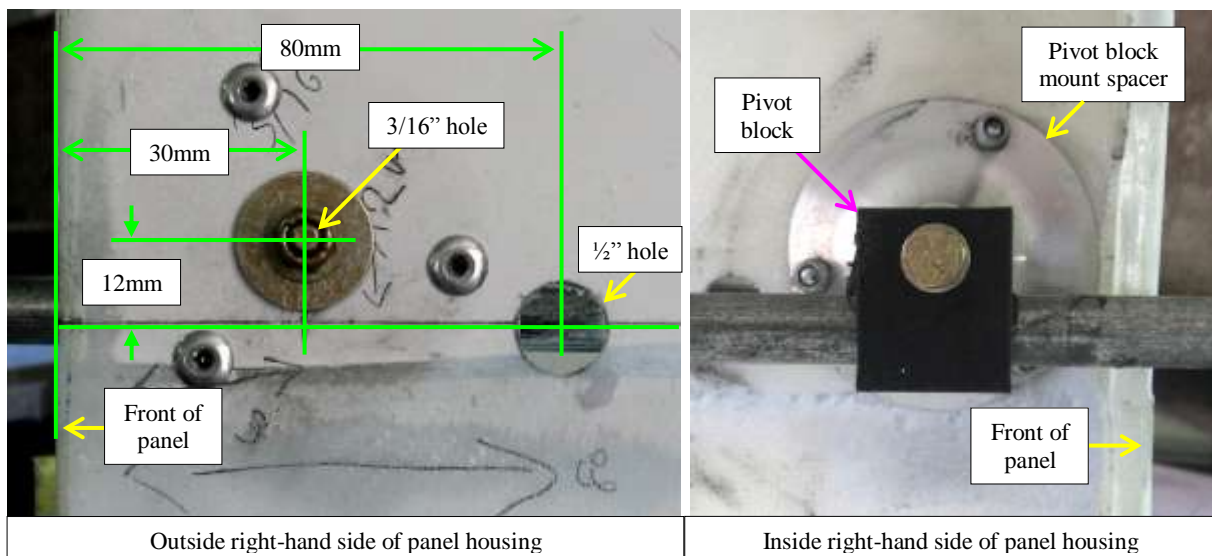

Mark a line on each side of the panel housing along the centreline of each throttle shaft.

Remove the instrument panel and set aside. Mark and drill the 3/16" and 1/2" holes as shown in the photo at above left.

Mix a small batch of flock and apply to the base of the pivot block mount spacer and then bolt the pivot block mount spacers to each side of the housing with an AN3 bolt through the 3/16" hole as shown in the photos above.

Drill 3 x 3/16" holes evenly spaced around the flange of the pivot block mount spacer and fit in place with TLR pop rivets as shown in the photos above. Leave overnight to cure.

Cut a length of Bundy tube to fit through the bolt hole in the pivot blocks.

Next day slip a throttle stop ring and a pivot block over each throttle input shaft and bolt through the pivot block and Bundy tube and the pivot block mount spacer with an AN3-17A bolt with a penny washer under the Nyloc nut tighten the nuts to safety.

The 1/2" hole will be used later for throttle idle stop adjustment.

Fit the instrument panel retaining nuts

At this point tape the instrument panel back in place and drill through the instrument panel mounting holes in the panel with a 5/32" drill.

Remove the panel and fit captive nuts behind each hole – use the captive nut as a jig (a complete captive nut assembly is shown below right) as a jig (shown at right) to drill the rivet holes– thread the screw part-way through the captive nut from the back and fit the exposed end of the thread into the hole, then drill the 2 x 3/32" rivet holes for the countersunk rivets.

Countersink the rivet holes just enough to make a countersunk 3/32" rivet sit flush and rivet the captive nuts in place and then enlarge the 5/32" holes in the panel to 3/16" to provide clearance for the screw threads.



Now the excess lip in the panel housing can be trimmed away around the captive nuts – mark a line and trim generally as shown in the photo above.

Leave enough of a lip for the panel to sit against, about 10mm, and mark around the captive nuts. Leave the solid section across the bottom of the panel – this will support the *Carb Heat*, *Choke* and *Cabin Heat* knobs later.

There may need to be some fine adjustment of the trimmed edge once the instrument panel has been assembled in the next task, after which the panel housing can be covered with your selected upholstery fabric.

This completes the *Post-Paint>Fuselage>Fit panel mounted throttle* task.



Post-Paint>Fuselage>Assemble instrument panel

Objectives of this task:

To fit all instruments into the instrument panel, fit all of the electrical wiring and terminate to multi-pin connectors ready for installation into the instrument panel housing.

There are 5 panel options as well as builder variations and so this task will address the fitting of hardware and both analogue and digital instrumentation in general terms and will use photos of Standard (analogue) and Jumbo (digital) panels to illustrate various aspects of the task. Refer also to the *Post-Paint>Fuselage>Electrical wiring diagrams* task.

Fitting of the hardware and instrumentation to the panel is not particularly difficult but the actual wiring is a task that requires *considerable* care and attention to detail.

A kit builder *can* do the wiring provided that he or she is careful and methodical. If you are not experienced at electrical wiring and the reading of electrical wiring diagrams then you may wish to consider having the wiring of the panel done by a specialist technician, or possibly a friend or acquaintance may have the necessary skills.

Materials and tools required:

Card #14 “*Option 1 & 2 Hardware*” or “*Option 3 & 4 Hardware*” or “*Option 5 Hardware*”

Card #16 “*Electric Flaps*” specifically the flap actuating switch and flap switch handle

Wire stripping and crimping tools

Prepare the work area

You will need a clean well lit workbench and a piece of foam about the same size as the panel so that the panel can be placed face down without any risk of scratches to the front face of the panel or the faces of the instruments.

All electrical connectors should be close at hand and your heat gun will be needed to shrink the coloured tags onto the wiring. All tools should be within easy reach.

There will be a lot of packing waste so empty your rubbish bin before starting.

Unpack the hardware and fittings

Strip all of the hardware and fittings from the Cards – use a knife to cut *around* each item and then peel the plastic shrink-wrap back and *away* from the item. Be very careful when cutting the noise suppression filter out of the wrap: do not cut near or through the wires.

Sort all of the items into groups: switches, circuit breakers, wiring, lights, etc.

Empty the bag of electrical connectors onto your bench top and sort the items into groups: note that the red female spade connectors are for single wires and the blue ones are for 2 wires. Do the same with the screws and fittings bag: select the black screws (2 lengths) and nuts, the silver screws and Nyloc nuts (M3 and M4) and the gold anodised captive nuts. The remaining items should be put aside for later use when installing the panel into the aircraft.

The M3 silver screws and Nyloc nuts will be used for busbar to circuit breaker connections, the M4 silver screws and Nyloc nuts will be used to fix hardware to the panel, while the black screws will be used to mount instruments to the panel. The gold anodized captive nuts will be clipped into the analogue instruments as each instrument is being fitted.

On factory built aircraft we sandblast and paint the heads of the M4 silver screws satin black so that they blend into the panel. You may wish to do the same before assembling your panel.

Fit the hardware to the panel

The panel assembly sequence is: prepare and fit the circuit breakers, then the switches and panel lights, then the instruments, radio(s), intercom and transponder.

The Standard panels have a single long earth busbar while Jumbo panels have 3 earth busbars, 1 for the circuit breakers, 1 for the panel lights and 1 for general use.

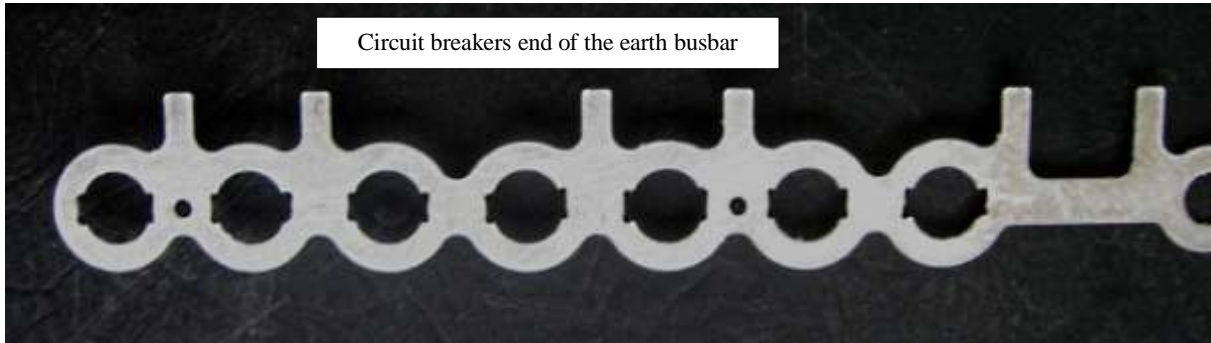

Prepare the circuit breakers and switches earth busbar by filing a 6mm notch on each side of each circuit breaker hole in order to clear the circuit breaker attachment clips as shown above.

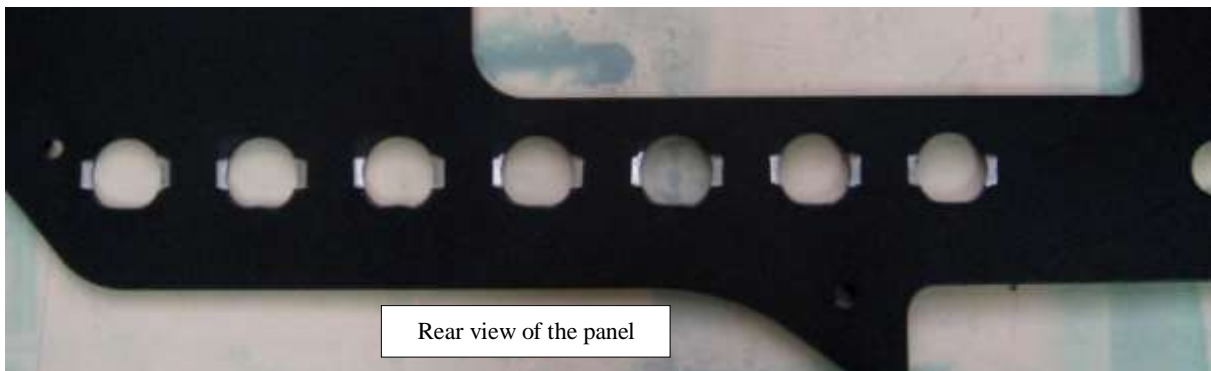

Prepare the panel for the circuit breakers by very carefully filing a 6mm wide 45° recess on the **back** of the panel at each side of each circuit breaker hole as shown above – this allows the circuit breaker attachment clips to seat firmly into the holes. Work carefully and take care not to mark the front of the panel. File the recess on all circuit breaker holes, even spares.

Prepare the 5 and 10 amp circuit breakers only by carefully drilling out the hole in each bottom spade connector to 3.3mm. This allows the main busbar to be bolted to the connectors. Support the connectors while drilling by placing a piece of plywood between them.



Fit the circuit breakers to the panel from the front – check the etched labels on the panel and the circuit diagram and fit the correct value circuit breaker to each hole. Press each circuit breaker in until the attachment clips click into place. Standard panel shown above.

Lay the panel face down on a soft surface and fit the earth busbar over the back of the circuit breakers. Fit the switches through the earth busbar and through the panel. Each switch has 2 retaining nuts: one nut will remain behind the panel and be used to tighten the switch in place and the other nut will be fitted to the front of the switch on the panel face.

Each 2-way switch is labelled on one side with the direction of the OFF and ON positions.

All 2-way switches follow the convention of UP = ON and DOWN = OFF which means that for most switches the machined groove in the threaded barrel of the switches will face downwards. The Magneto switches will be the opposite, where the DOWN position will connect the magneto to earth while the UP position will remove the earth and make the magnetos live. Accordingly the magneto switches will have the groove facing upwards.

The 3-way flap switch should be fitted with the groove facing downwards.

Place all the switches into the panel and tighten the front nuts finger tight, then check that each nut is flush with the end of the threaded barrel. Adjust the rear nuts to suit.



Lay a metal ruler along the bottom flats of the front retaining nuts as shown above and gently adjust each nut until all the flats are in line, then use a spanner to tighten the rear nuts firmly.

Recheck each switch for alignment and make any final adjustments that may be needed.



Drill through the 2 mounting holes in the earth busbar between the circuit breakers and bolt the busbar to the panel with 2 M4 screws and Nyloc nuts (shown circled above). Don't tighten the nut closest to the centre of the panel just yet (shown as the right hand nut above); the master earth will fit under this later during the wiring process.



Fit the LED lights through to the panel and busbar. The green light is the Master light; the rest will be red lights. The connectors are labelled [+] and [-] – align all the [+] connectors to face in the same direction. Tighten the retaining nuts firmly. Fit the Electric Turn Coordinator (ETC) OFF/ON switch near the instrument.

Fit the Starter button and the keyed Master switch if using one, tighten using pliers.

The earth busbar(s) have earthing tags that must now be bent up 90° - use a screwdriver and pliers to bend each tag up, circled in photo below. These tags will be used as earth terminals.

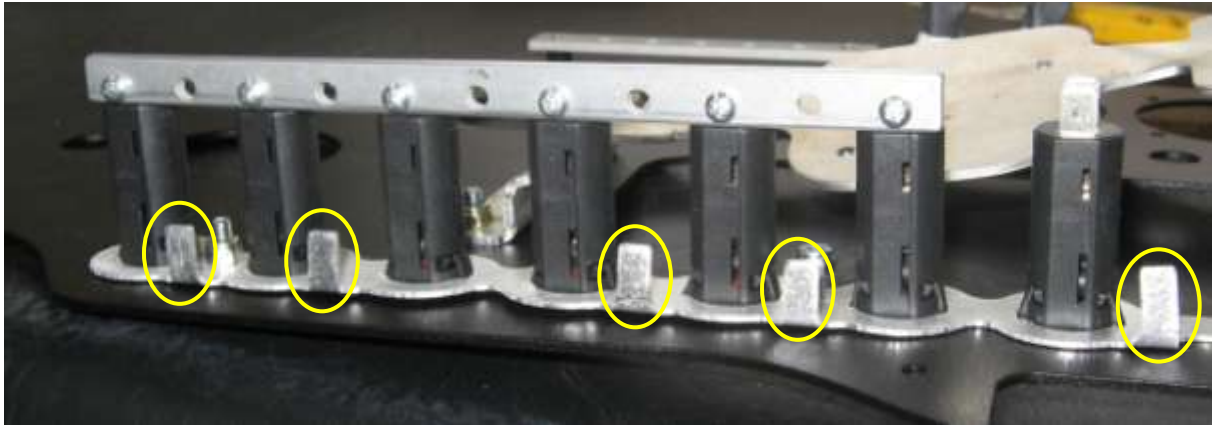

Bolt the main busbar across the lower side of the bottom contacts on the 5 and 10 amp circuit breakers only using the M3 silver screws and Nyloc nuts as shown above. Tighten firmly only: these screws and nuts are very small so take care not to over-tighten them. Note that the main busbar does **not** connect to the *Master* 15 amp circuit breaker.

Fit the black “U” shaped safety bracket between the Mag switches.

Now the Avionics busbar can be fitted.

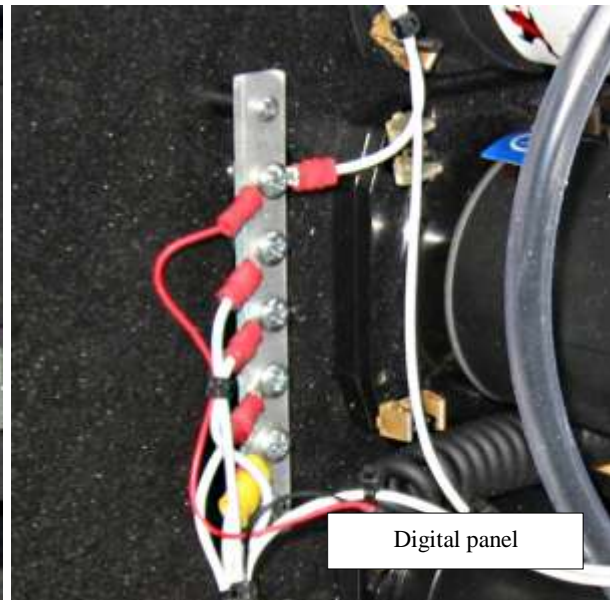
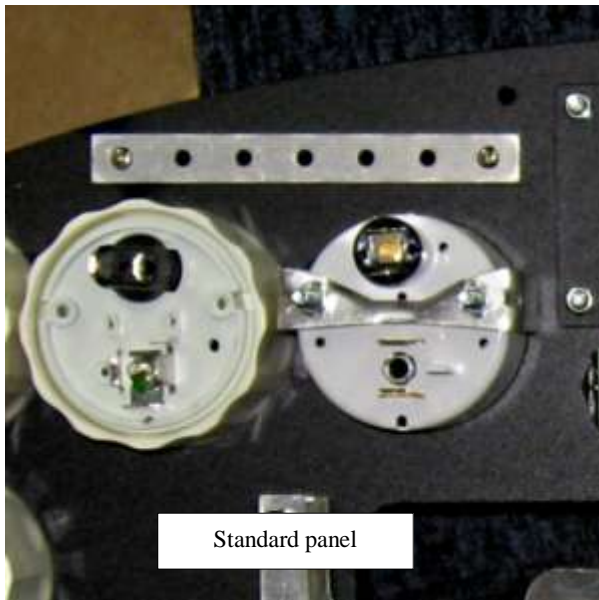

For a Standard panel the avionics busbar is located behind the “No Smoking” label above the engine instrumentation, see photo at left above – hold the busbar against the front of the panel and carefully mark and drill through the hole in each end of the busbar, first positioning the busbar so that the screw holes will not obscure the labelling.

For a Jumbo panel the avionics busbar will be located vertically to the right of the analogue instruments as shown in the photo above right.



There are 2 nylon standoffs in the hardware pack – these must be used to isolate the avionics busbar from the panel itself, as the panel will be earthed. It will be necessary to countersink the screw holes at each end of the busbar to allow the screws to thread into the nylon standoff. Mount the avionics busbar to the panel and tighten the mounting screws firmly.

Unpack the instruments and radios



Each instrument box will have a Jabiru stock number written on the top in marker pen. Take each instrument out of its box, cut the tagged end of the box off and discard the box. Write the Jabiru stock number on the tagged end and put it aside – this information along with all other instrument serial numbers will be entered on the *Aircraft Identification* form in this Manual.

Discard any “O” rings from around the instruments: these will not be required.

The *Microair* VHF radio and Transponder can be removed from their boxes at this time. Each unit is wrapped in a silver electrostatic bag. Do **not** cut the bag open at the end, but rather cut the bag open along the **side** of the bag and remove the unit. Cutting across the end of the silver bag risks cutting into the face of the unit and must be avoided at all costs.

Unpack the *Microair* VHF radio/intercom and Transponder wiring harnesses.

If fitting a GPS unit you will need the appropriate mounting bracket and wiring harness.

If the GPS is a *Garmin* product the mounting bracket must be removed from the end of the clamp assembly and screwed to the Jabiru panel mount bracket as shown at right.

To mount the *Garmin* 296/495 in a Standard panel, refer to the photo at right for drilling dimensions:

If the GPS is an *AvMap* unit the supplied panel mount bracket will be used.

If the GPS is any other brand or model refer to the manufacturers literature for mounting instructions.

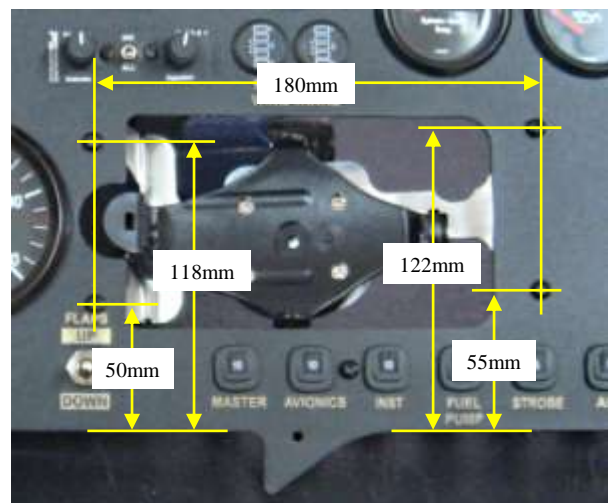

Fit analogue instrumentation

Analogue instrumentation (ASI, ALT, VSI, ETC, engine instruments) will require each individual wire to be connected to the back of each instrument. There are 3 methods of fitting analogue instruments: screws through the panel and into the instrument (flight instrumentation), or retaining brackets or retaining screw rings (engine instrumentation).



The photo above shows the analogue instrumentation for a Standard panel. Note the *Garmin* GPS bracket above the circuit breakers. The angle of the bracket faces the GPS unit towards the pilot: in the photo above the bracket has been bent to face the GPS slightly upwards too.

When fitting the flight instruments the gold anodized captive nuts are first inserted into the rear of the screw holes in the instrument and then held in place with a finger while the screw is fitted from the front, through the panel and the instrument, and tightened.

There is not a lot of room around the instruments so the order of fitting is important.

Generally the approach is to start from the centre of the panel with the engine instruments: CHT, Oil pressure and temperature and Voltmeter, and then move to the Tacho and then the VSI and ETC.



At this time the 2 points at the bottom of the panel should be placed on a known level surface and the balance ball (circled above) should be checked to see if it is in the centre.

If it is not, remove the instrument and enlarge the mounting holes slightly (to about 3/16") then refit the instrument and rotate it until the balance ball sits correctly when the panel is held level then tighten the screws.

Now the Altimeter and ASI can be fitted along with the wing tank fuel level digital gauges.

Fit digital instrumentation

Digital instrumentation (EFIS, EMS, radio(s), transponder, intercom, GPS) will usually have a pre-wired harness and a multi-pin connector fitting at the rear of the instrument.

The *Dynon* brand EFIS displays are supplied with mounting hardware and the fitting method is to fit the instrument through the panel and lay the panel face down, then place the mounting bracket over the instrument and carefully mark the position of the mounting holes on the panel with a sharp drill. Remove the instrument, drill the holes through and fix the mounting bracket into place with M4 screws and Nyloc nuts and then fit the instrument into the mount.

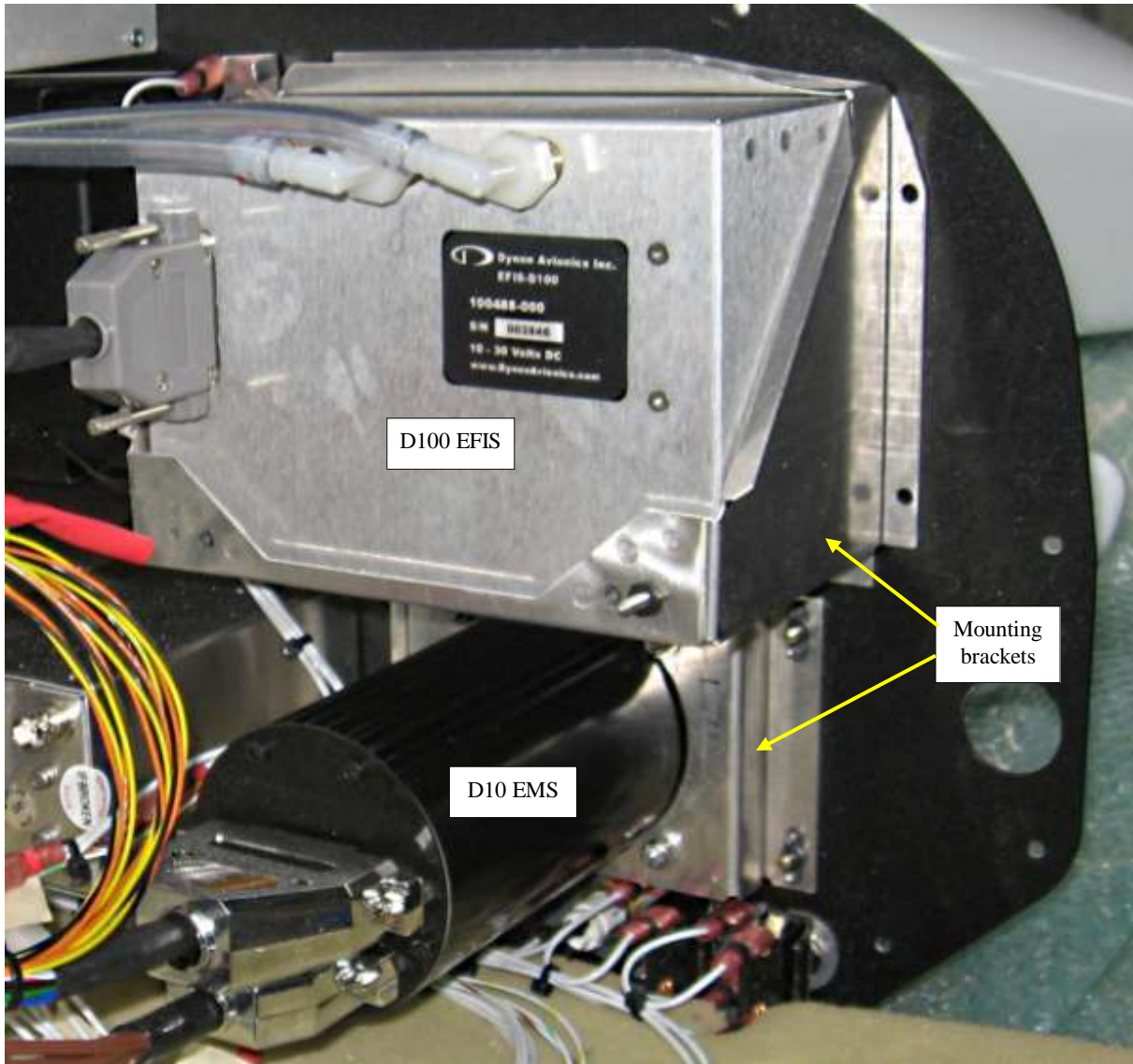

The photo above shows a *Dynon* D100 EFIS (top) and a D10 EMS (bottom) fitted to a Jumbo panel. Note the mounting brackets (arrowed) that attach each instrument to the panel.

Finishing

For both the Standard and Jumbo panels you can now fit the intercom unit and faceplate or sticker, the VHF radio(s) and the transponder to the panel. Each unit is retained by screws that are supplied with the unit.

Any blank spaces remaining in the panel can be covered with the supplied plate(s) or plugs.

Wiring standards

Before you start wiring the panel we suggest that you follow a few wiring standards:

- All wires and connectors will be identified by a colour coded heat-shrink tag or label,
- Wiring insulation will be stripped back 4mm for all connectors,
- All wires will be crimped into the appropriate connectors using a crimping tool,
- No more than 2 wires will be crimped into any one connector.

Heat shrink tubing should be cut into short lengths (about 2 or 3mm) and used for tagging each electrical connector or wire in the following manner:

- Red = positive
- Black = negative (earth)
- White = signal

Cut about 20 of each colour to start with and cut more as needed.

Put a strip of masking tape along the bottom rear of the panel under the switches and circuit breakers and label each one – this will save you having to keep lifting the panel to read the labels on the front and that will make the wiring a little bit easier.

Wiring the panel

This is a one-wire-at-a-time process that cannot be rushed.

The objective is to use lengths of wire that can later be zip-tied together to form a tidy wiring loom. The *before* and *after* photos below show how factory wiring is arranged into a loom:

From this:

(We use pre-cut wire lengths for our standard panel layouts)

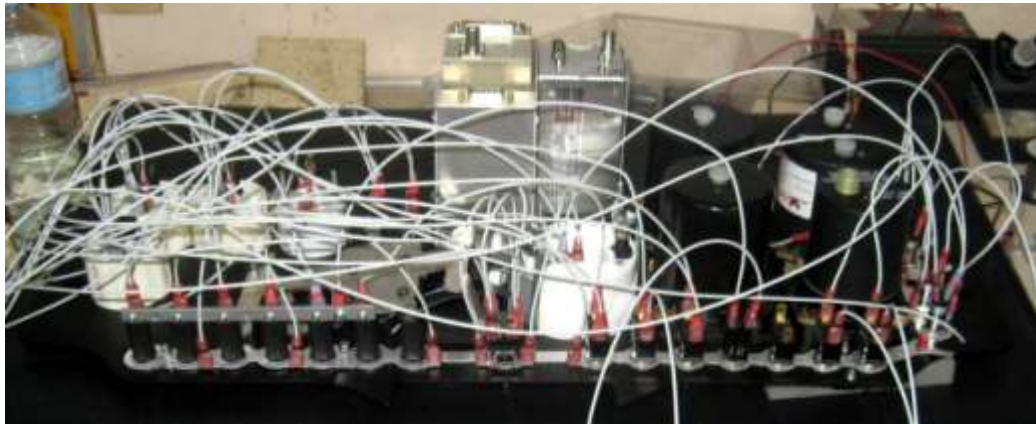

To this:



The process is to put one wire on at a time, so if you were to start with the wire from the Avionics circuit breaker to the Avionics switch you would strip 4mm of insulation off one end of the wire and crimp a red female spade connector to it then heat shrink a red tag to the connector. Push that connector onto the circuit breaker terminal and measure out enough wire to reach the Avionics switch while allowing a bit of height above the panel as shown in the photo at right. Cut the wire, strip 4mm of insulation off, slip another red tag on and crimp another red female spade connector in place and heat shrink the tag on.



With that wire fitted in place you can then square off the wire by bending it and then fit the next wire so that it would end up being the same height above the panel and then keep adding one wire at a time until the panel is fully wired, then you can use zip ties to tidy up the wiring into a loom as shown in the bottom photo on the previous page.

Note that there are 2 main wire sizes: 16 gauge, which is used for most of the wiring; and 10 gauge, which is used for the main battery wiring, all shown on the electrical wiring diagrams.

Some wires will be common, such as the power supply to the engine instruments. In these cases the suggested approach is to loop from instrument to instrument by crimping 2 wires into each blue connector. Do not crimp more than 2 wires into a single connector or you run the risk of having some of the wires pull out of the connector, so stay with 2 wires maximum.

Quite a lot of wires will go to other parts of the aircraft, and these wires are terminated into one of five multi-pin connectors for ease of installation and maintenance. If one end of a wire will go to a multi-pin plug then you must label that end clearly (use masking tape for the label) before going to the next wire. If you do *not* label it you risk having a real problem later.

Multi-pin connectors are supplied in 2, 4, 6 and 8 pin types depending on the instrumentation options that you have ordered with your kit. In all cases the pins are standard male and female spade connectors, just the same as the normal wiring connectors except without the insulation, and each connector will be crimped on to the wire in the same manner. The connectors will then be pushed into the respective half of a connector body until they click into place.

With the *male* spade connectors (that fit into the *female* connector body) care must be taken that the stripped end of the wire does **not** extend beyond the end of the crimp area of the connector, otherwise the connector will not be able to clip into place in the connector body.

The photo at right shows the wrong way and the right way to crimp a wire into a male spade connector. Note that in the “Wrong” example the bare wire has been pushed too far into the crimp area of the connector, as indicated by the red arrow, while in the “Right” example the wire stops at the end of the crimp area of the connector, as indicated by the green arrow.

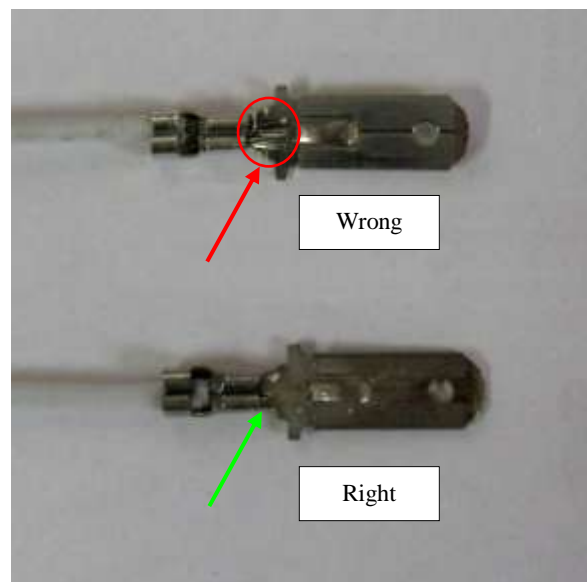

Fitting the multi-pin connectors

What follows is the pin layout that is used in our factories. Some pins may not be used on your particular panel in which case simply leave that pin unwired, and the connector layout here will be referred to again in the *Post-Paint>Fuselage>Install electrical wiring* task.

Each connector is assigned a group of wires that go to a similar physical location.

The connector pairs should be marked from A, B, C, D or E as shown on the next page, and a mark should be made on the corner beside pin #1 for each connector. If you have more than 1 QK6 connector you should plan to fit 1 male and 1 female QK6 connector to the panel to lessen the possibility of plugging the wrong pair of QK6's together.

The diagram below shows the pin numbering convention for each of the 4 connector types:

QK8

Male

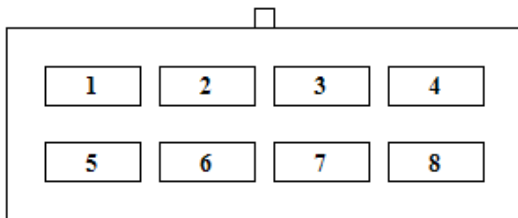

Female

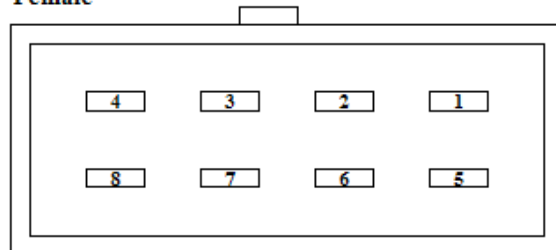

QK6

Male

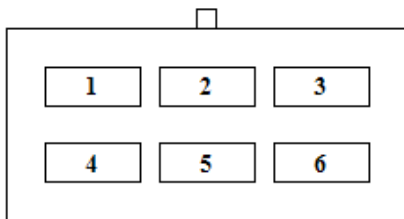

Female

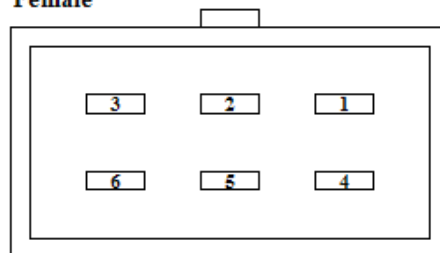

QK4

Male

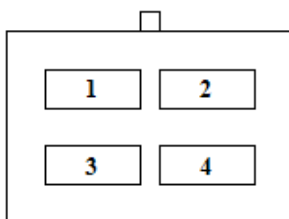

Female

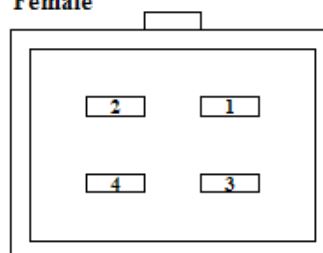

QL2

Male

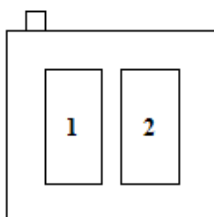

Female

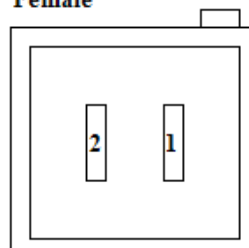



Group the wires for each plug together and trim each group to an even length, then strip 4mm from the insulation of each wire and fit the appropriate connector type to each wire: *male* spade connectors for a *female* connector body and *female* spade connectors for a *male* connector body. References to *male* or *female* will mean the connector body.

Hold the connector body in the correct orientation and insert each spade connector from the rear of the connector body: push into place until a solid click is felt – this indicates that the spade connector is correctly seated in the connector body.

If a spade connector is not seated correctly it may be forced back and out of the connector body when the 2 halves are joined, so double check that each spade connector is fully seated.

The connector pin assignment shown below will be referred to again when the other side of each connector is fitted in the *Post-Paint>Fuselage>Install electrical wiring* task:

Connector A: Engine instrumentation, QK8 connector, 16 gauge wire

- | | |
|-------------------|------------------|
| 1 CHT positive | 5 CHT negative |
| 2 Tacho positive | 6 Tacho negative |
| 3 Left MAG | 7 Right MAG |
| 4 Oil temperature | 8 Oil pressure |

Connector B: Electrical, QK6, 16 gauge wire

- | | |
|-----------------------|----------------------------|
| 1 Starter | 4 Regulator to main busbar |
| 2 Starter pilot light | 5 EFIS negative |
| 3 Charge pilot light | 6 Fuel pressure |

Connector C: Main power, QL2 connector, 10 gauge wire

Note the use of the heavier 10 gauge wire to this connector.

- | | |
|--------------------|----------------------------|
| 1 Battery positive | 2 Battery negative (earth) |
|--------------------|----------------------------|

Connector D: Wings 1, QK6 (or QK4 if no landing light) connector, 16 gauge wire

- | | |
|--------------------------|------------------------------|
| 1 Fuel pump positive | 4 Fuel pump negative (earth) |
| 2 Flaps UP | 5 Flaps DOWN |
| 3 Landing light positive | 6 Landing light negative |

Connector E: Wings 2, QK6 connector, 16 gauge wire

- | | |
|----------------------------------|----------------------------------|
| 1 Strobe positive | 4 Strobe negative |
| 2 Right wing fuel gauge positive | 5 Right wing fuel gauge negative |
| 3 Left wing fuel gauge positive | 6 Left wing fuel gauge negative |

You will have used one half of each connector by now. Because you will not be using the other halves until the *Post-Paint>Fuselage>Install electrical wiring* task, store the remaining connector parts in the plastic boxes that they came in until you need them. This simple action will make your life much easier when wiring the rest of the aircraft so do it now: put all the boxes into a plastic bag, label it clearly and put it aside where you can easily find it later.

Fit the noise suppression filter into the power wire from the Avionics busbar to the VHF radio (use male and female spade connectors) and zip tie the filter to the loom.

Fit digital wiring harnesses

The digital wiring harnesses can now be fitted to the plugs at the rear of the digital instruments and the VHF radio, transponder and intercom. Tighten the plug screws by hand.

There is an MP3 player input socket on the intercom harness and this may now be fitted to the panel if desired. Select a location on the panel where the cable to the MP3 player will not obscure any instruments and drill a 6mm hole through the panel and mount the socket.

Use zip ties to hold the digital harnesses to the wiring loom.

Tube up to the pressure instruments

Fit the nylon fittings to the rear of the pressure instruments – decide first where the static tubing will run and use elbows and tees to suit. Take care not to cross-thread the nylon fittings. Run the static tubing as required and leave it about 200mm below the bottom of the panel. Run the pitot tubing from the ASI and trim to the same length. Mark the pitot tubing clearly so that it will not be mistaken for the static line.

Zip tie the pressure tubes lightly (do not crush them) to the wiring loom.

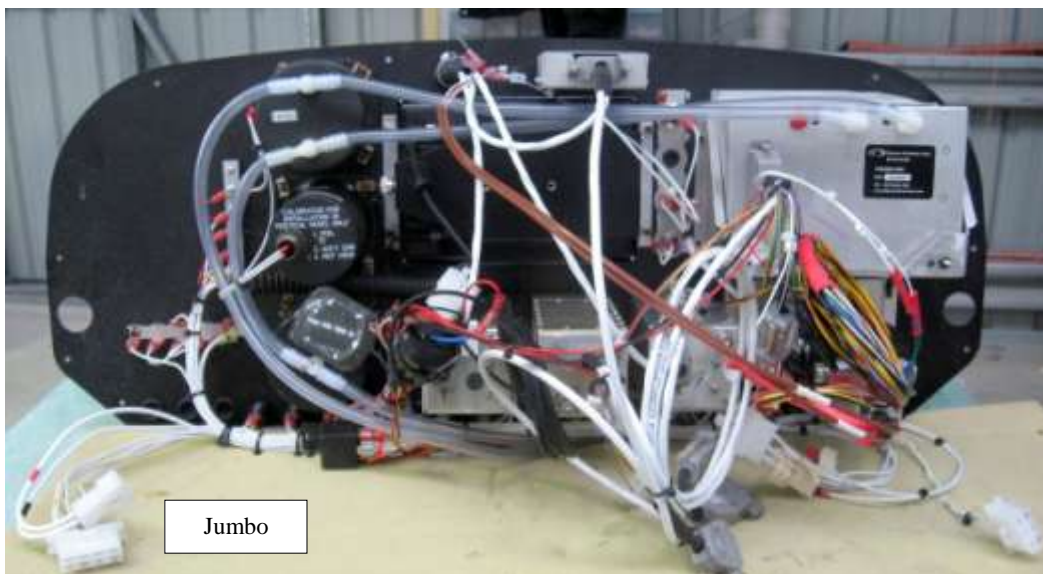
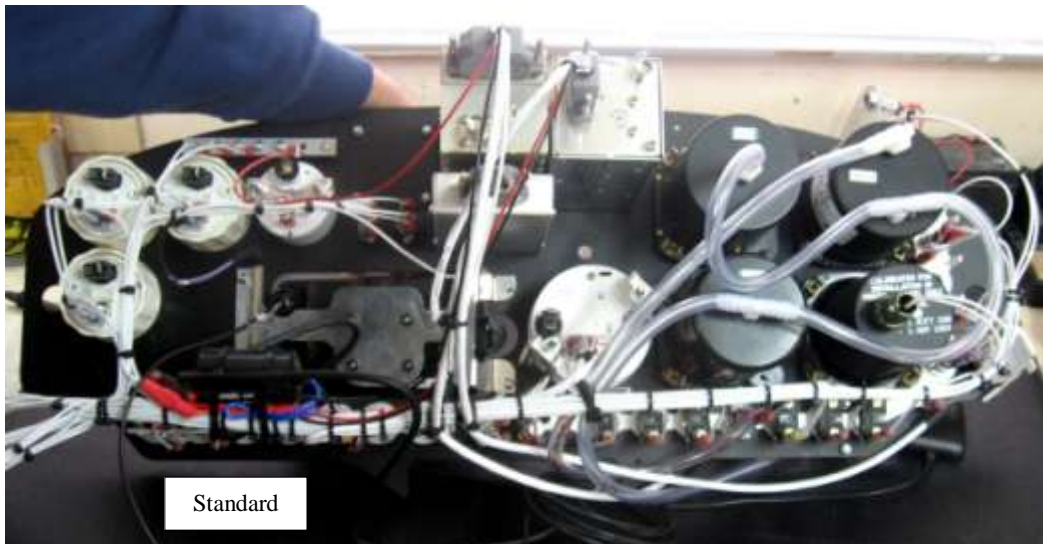

This completes the *Post-Paint>Fuselage>Assemble instrument panel* task.



Post-Paint>Fuselage>Electrical wiring diagrams

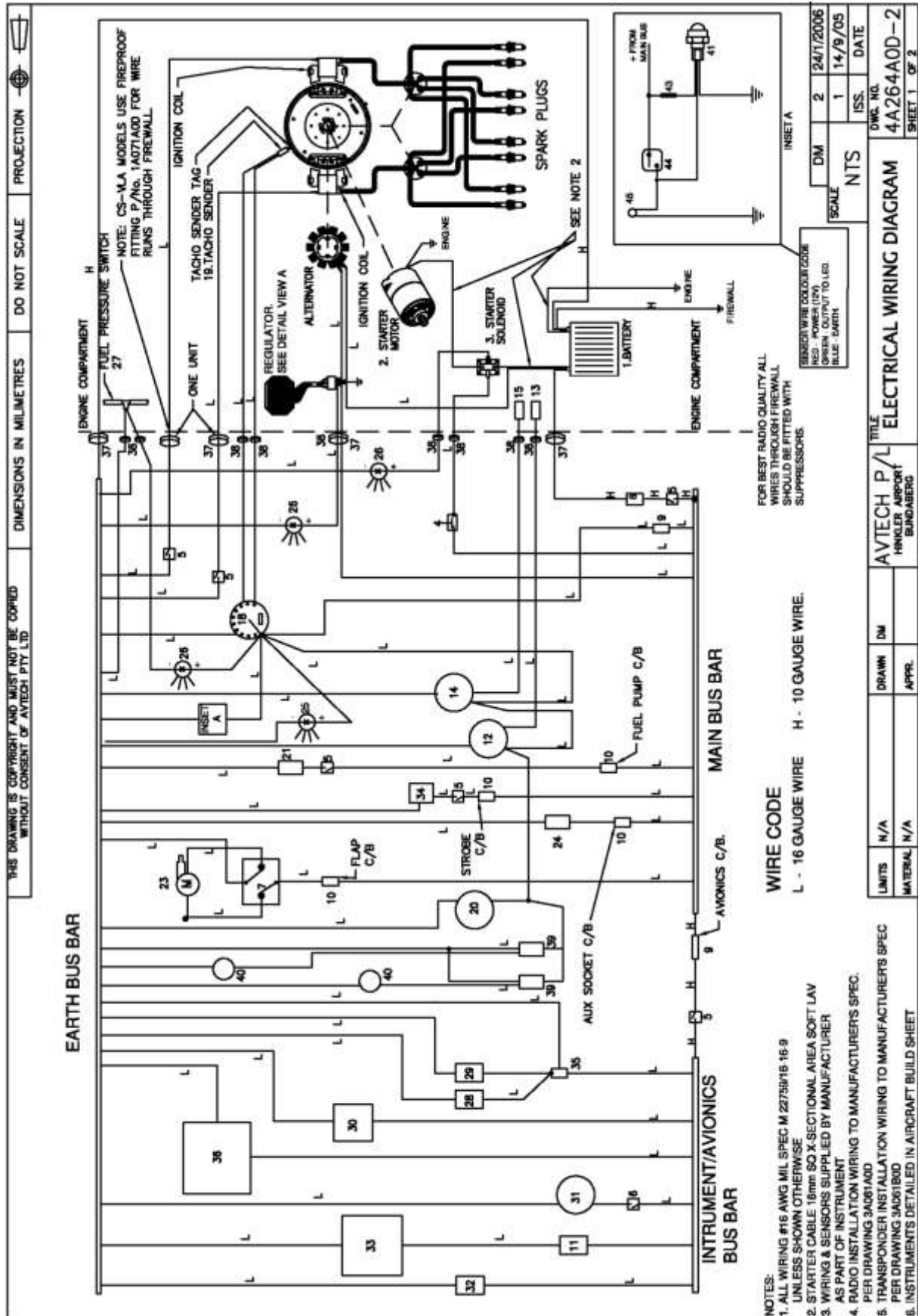

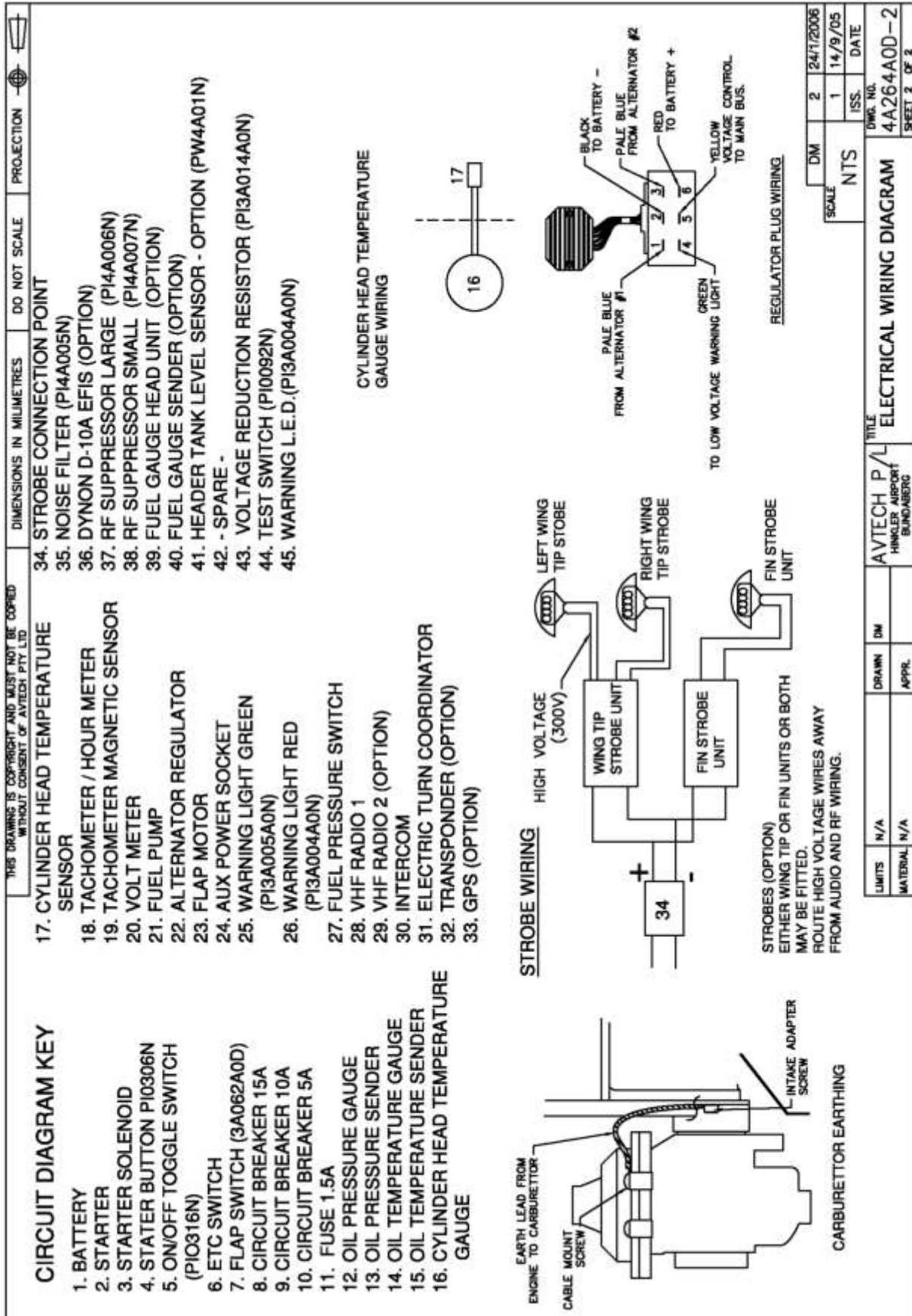

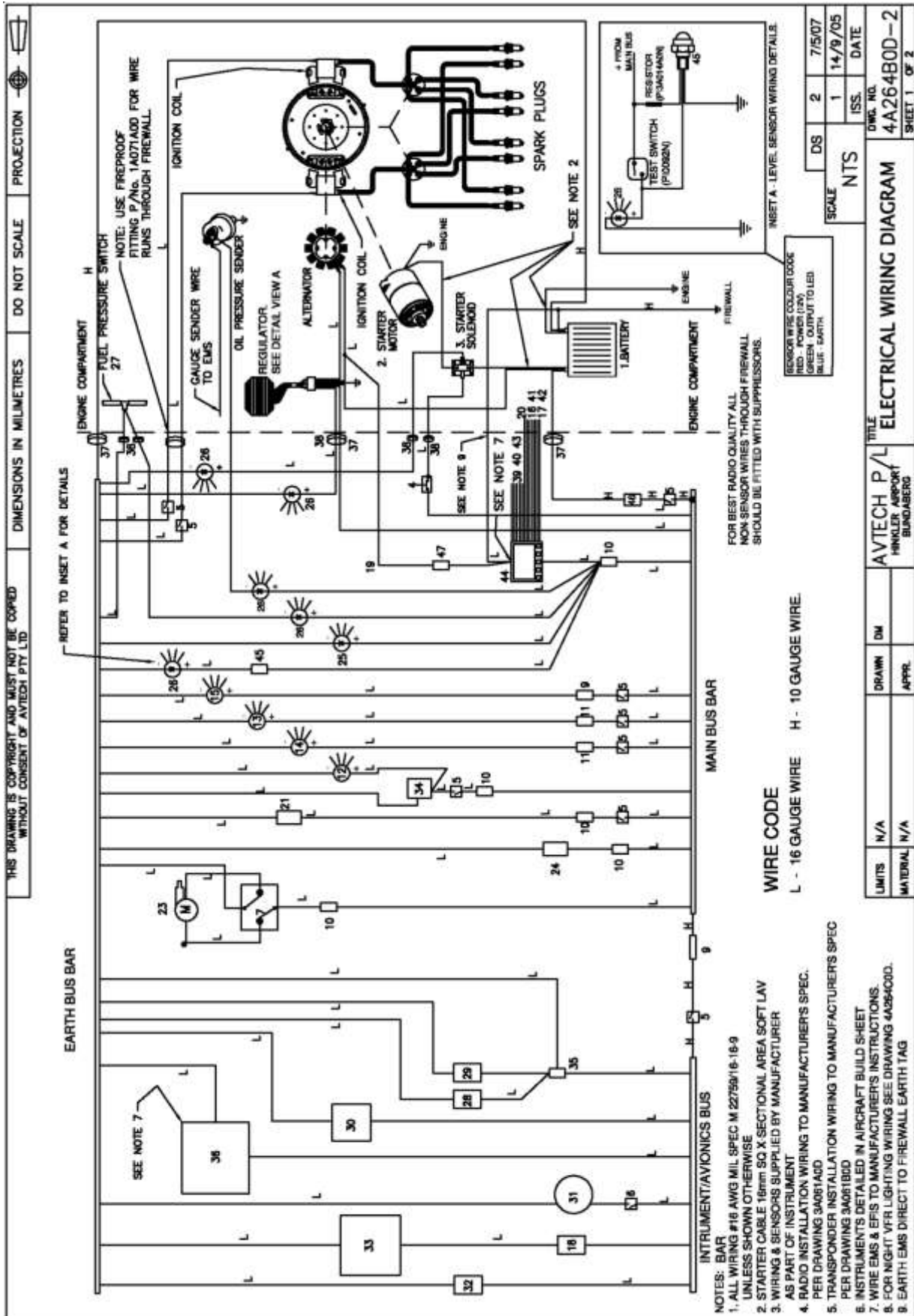

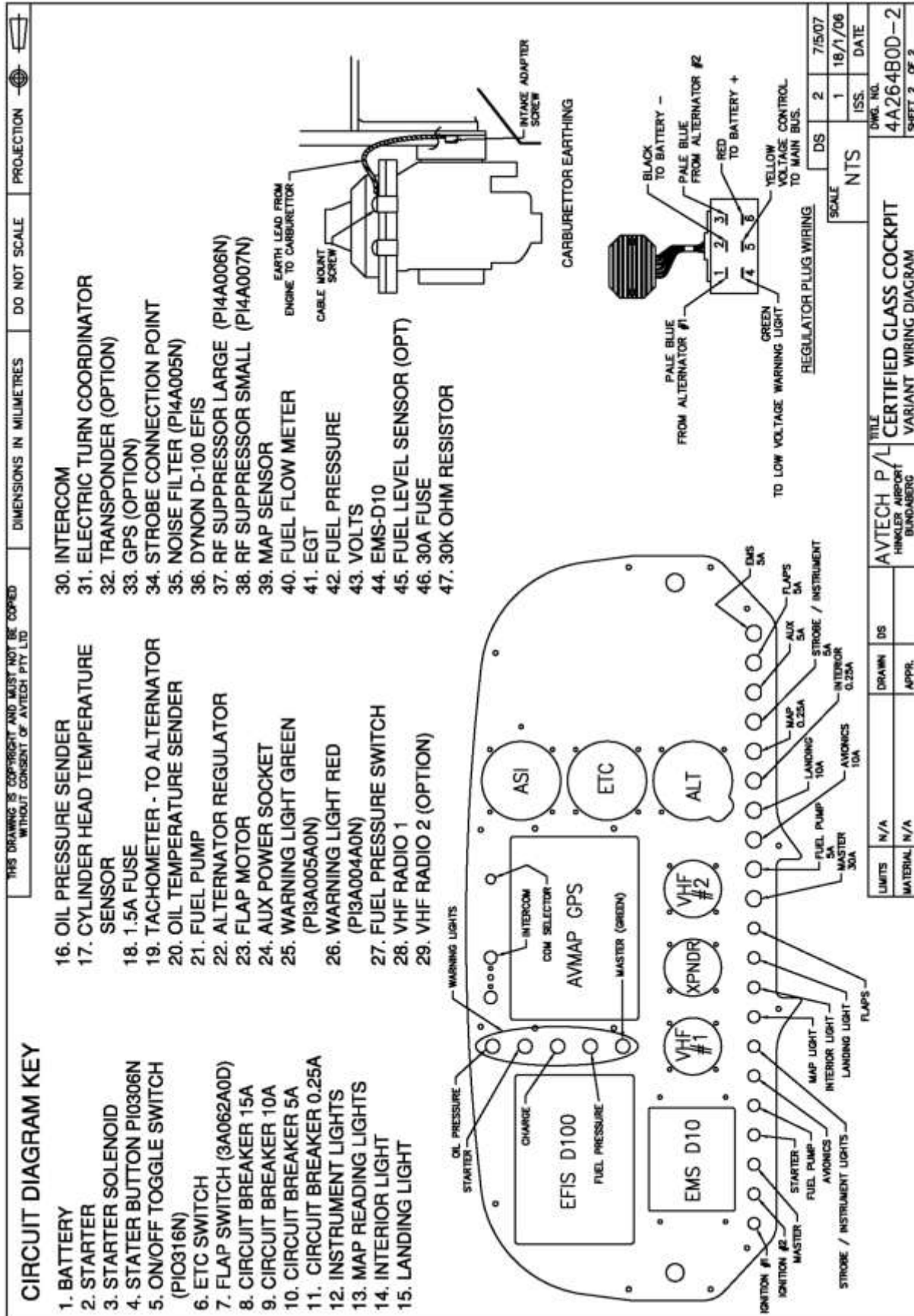

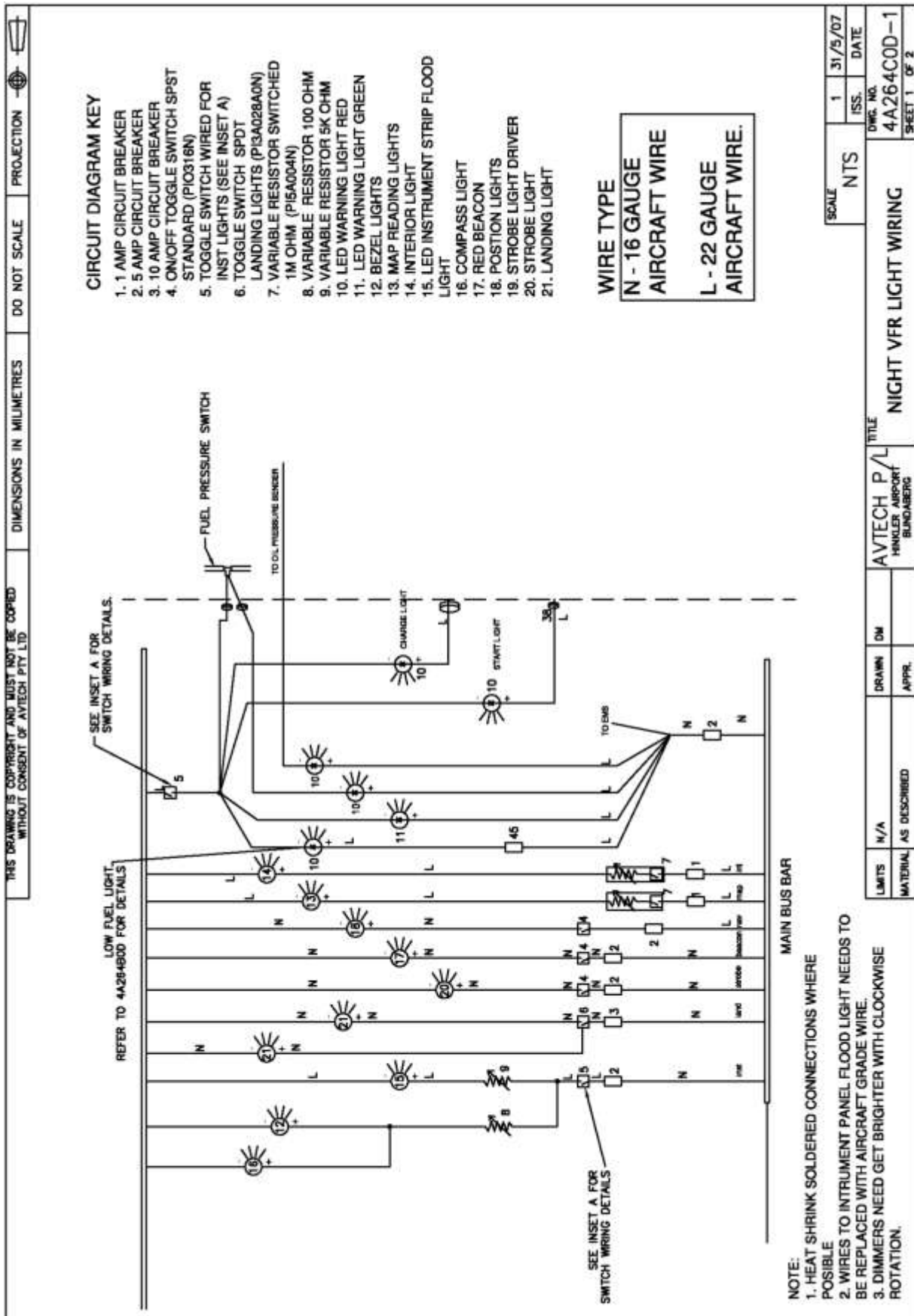

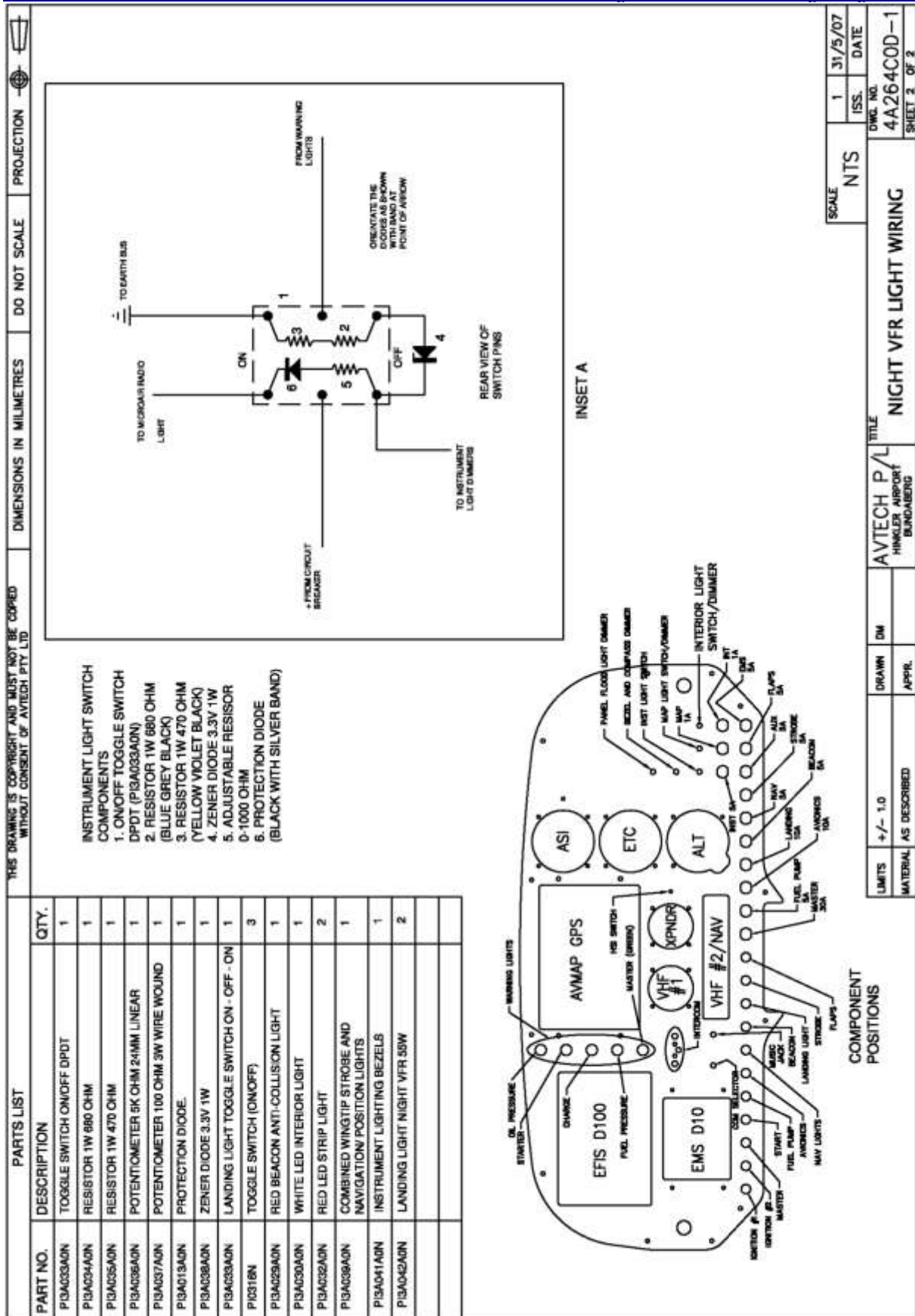

This completes the *Post-Paint>Fuselage>Electrical wiring diagrams* task.

Post-Paint>Fuselage>Interior>Fit upholstery 1

Objectives of this task:

To fit all of the stage 1 upholstery into the aircraft.

This task assumes that you will be using the Jabiru upholstery kit. If you *are* using the Jabiru kit it contains extremely detailed instructions, however you may want to use your own materials in which case this task can be used for more general guidance.

Materials required:

Jabiru upholstery kit or equivalent

High heat contact adhesive

Adhesive thinners and/or Acetone (for cleanup)

Dry fit

Start by cleaning your workshop floor and then lay out the contents of your upholstery kit and work out what panel goes where. In general the unedged panels are fitted before the edged panels, so the unedged panels will be for the larger areas: sidewalls and roof coverings and the like, while the edged panels will be the finishing panels where the edges will be seen.

Take your time and test fit each panel – it is *much* easier to do this now without adhesive! Consider labelling the location of each panel with a sticky paper tag on the good side.

Adhesive

Each panel will be glued in place with contact adhesive – the back of the panel and the surface to which it will be attached are both coated and the adhesive is allowed to dry, then when both surfaces are pushed together they are there to stay. Needless to say you want to be **really** sure of your positioning *before* pushing the surfaces together.

In our factory we spray the adhesive onto the back of the fabric and use a brush to apply it to the fibreglass but you can brush both surfaces. Do not apply too much adhesive – if you do it can bleed through the fabric. Just a thin coat is quite enough.

Sequence

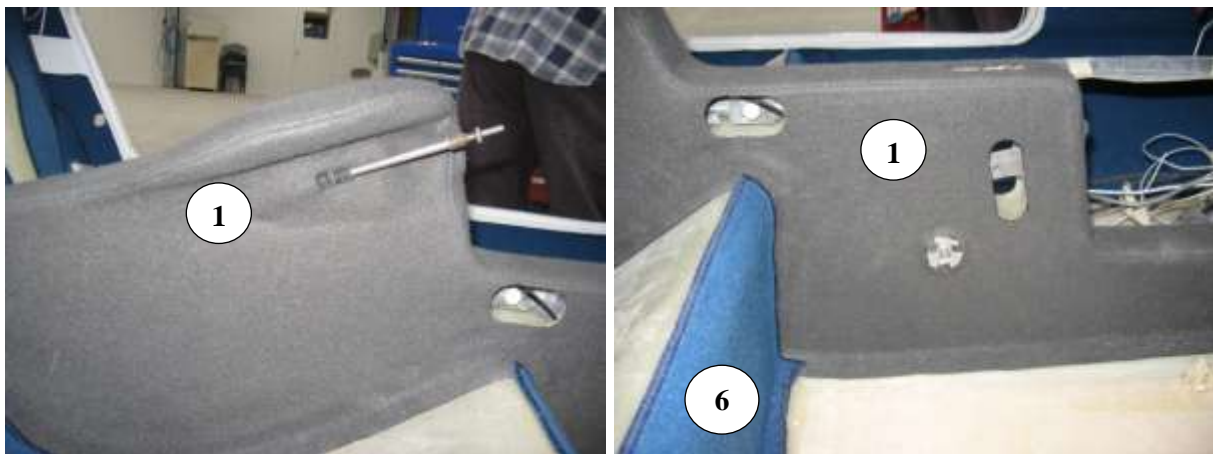

1. Console – fit the tailored console cover, taking care to align the seams correctly. Fit along the top first, then carefully roll the cover down the console and fit along the sides, working on one side at a time, until the cover is fitted.



2. Firewall – glue the 10mm foam layer to the firewall and then glue the fabric to the foam. Cut around the ribs as required. Lower firewall – fit the fabric down and back along the floor slightly and also over the rudder pedal mounts.
3. Windscreen pillars and firewall surrounds. These areas are covered by several small pieces that each cover a rib or brace. **Note:** the fuel tank wiring should be fitted inside the front pillars before covering them. Refer to the *Install electrical wiring* task.
4. Front sidewalls – cut out the vent openings after the panel has been fixed in place.

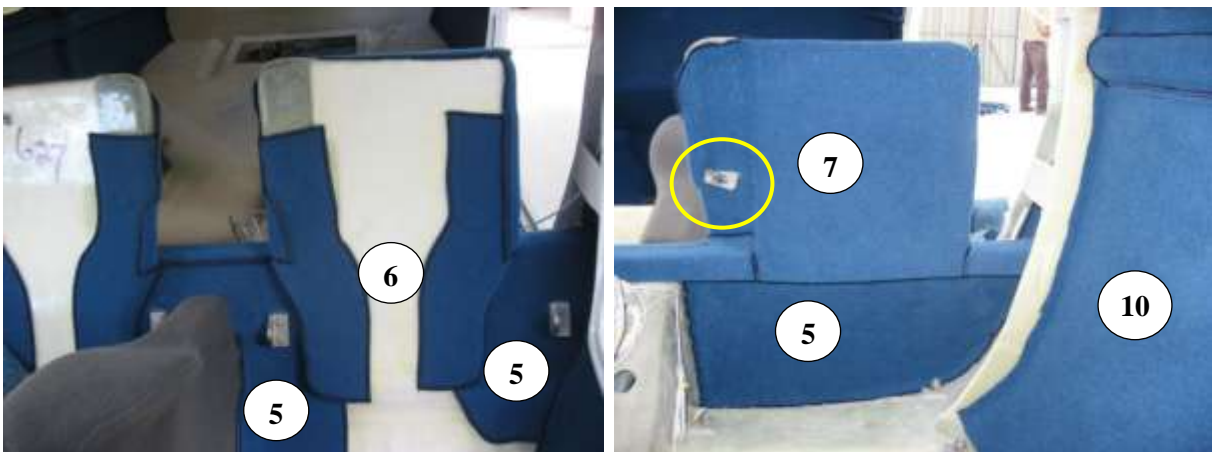

5. Crossbeam (front and back) and middle sidewalls behind the front doors.
6. Seat sides and base up to the bottom of the door sills.
7. Seat backs – cut around the aileron cable brackets (circled in yellow) before fixing the panel in place.

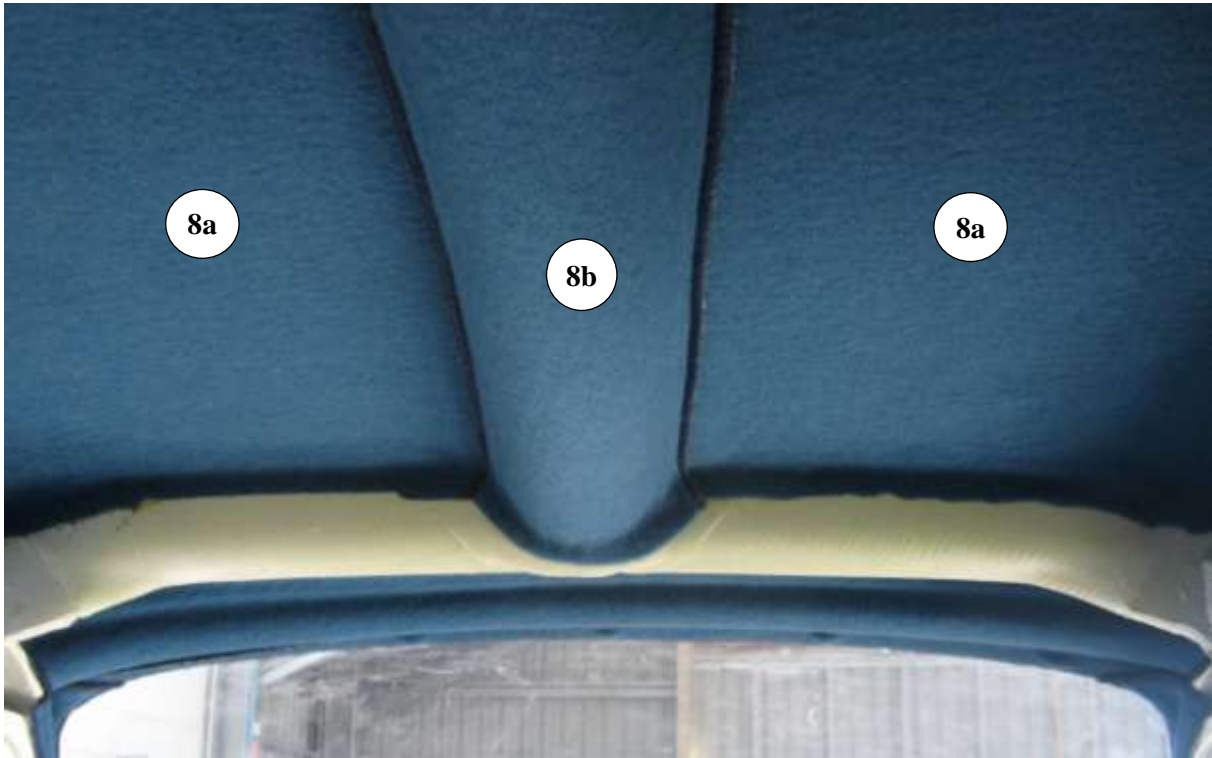

8. Front hood lining/roof: main panels (a) then the longitudinal rib (b)
9. Rear hood lining/roof as for the front (not applicable to J160/J170)
10. Rear sidewalls (not applicable to J160/J170)
11. Door panels
12. Door pockets – attached with snap fasteners and Velcro
13. Instrument panel housing
14. Cable covers and all other small trim items.

Clean up any excess glue with adhesive thinners or Acetone. Do not get any adhesive thinners or Acetone on vinyl or leather.

This completes the *Post-Paint>Fuselage>Interior>Fit upholstery 1* task.

Post-Paint>Fuselage>Install electrical wiring

Objectives of this task:

To install all of the electrical wiring in the aircraft and connect to the multi-pin plugs.

Each wire will need to be cut from the supplied coils of aircraft grade wire. The length required will vary depending on how you choose to route the wire and so it is difficult to give any exact lengths, but generally you should allow a little extra length to be on the safe side.

Study the photos in this task to see how we route our factory wiring before starting work.

Materials required:

Wiring Kit, as well as both the *Electrical wiring diagrams* and *Assemble instrument panel* tasks for reference and for pin assignment for the multi pin connectors.

Preparation

Before heading out to the aircraft there are a couple of things that need to be prepared:

The 2 tachometer (tacho) sender unit wires will need to be soldered to 2 x 700mm lengths of 16 gauge wire as shown at right.

Because soldering hardens the wire there is a risk of the wire breaking just beyond the solder joint, so the wires are joined by twisting the bare ends of the tacho wire around the bare ends of the 16g wire and soldering them together and then doubling the thinner wires back and covering each, and then both, wires with heat shrink tubing, all as shown below.

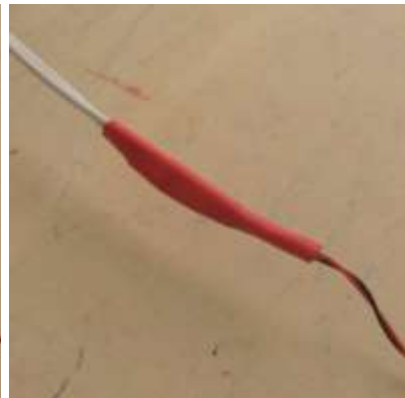
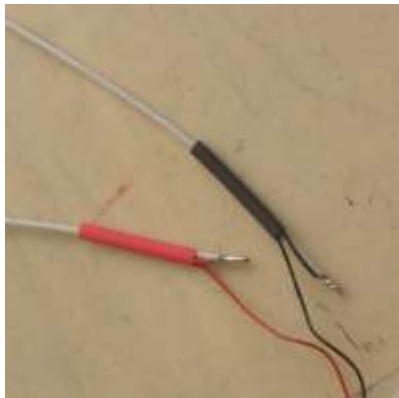
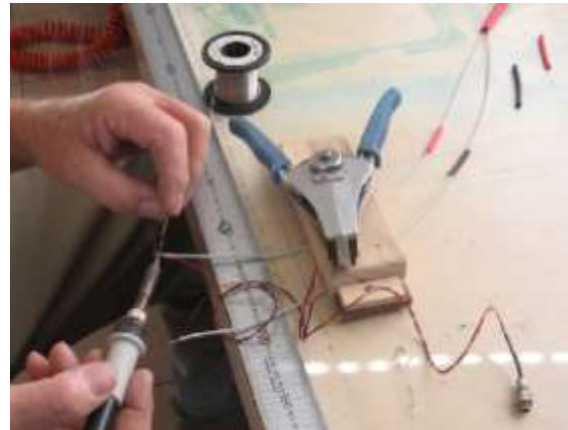

This method provides a much safer joint that allows the wire to flex without the danger of breaking near the solder joint. Label each white wire as being positive (red) or negative (black).

The CHT sender plug halves can now be connected and then the connector halves can be fixed together with 2 zip ties as shown at right.

Cut off the ends of the zip ties.



Engine wiring

All wires will need to be long enough to route from the respective sources, around the engine in the manner shown, and either to a connection point on the firewall in some cases or through the firewall plus about 300mm for connection to a multi-pin plug for the majority of cases.

All wires to multi-pin plugs *must* be labeled (use masking tape) to avoid later confusion.

Refer to the *Electrical wiring diagrams* task (found immediately before this task) to see where each wire will be connected to and plan the lengths accordingly.

Careful consideration must be given to the routing of wires around the engine. All wiring in the engine compartment must be kept well away from all hot and/or moving parts.

The supplied white wire is all aircraft grade and has high temperature insulation but care must still be taken to route away from obvious heat sources such as the exhaust system.

Wire the oil temperature and pressure senders

These senders are located on the left front of the engine and the single wire from each unit is routed back under the cylinders to the rear of the engine and zip tied to the pushrod tubes.

Strip 4mm of insulation from each wire and crimp a red female spade connector and a black heat shrink tag to each.

You will need to cut the insulation from the oil temperature connector as shown at right to allow it to fit over the 'button' pin on the oil temperature sender. Note the black heat shrink tag – this sender unit measures the resistance to earth.



Connect to the oil temperature sender unit, which is located just above the drain plug on the sump. Crimp over the end of the connector when it has been fitted to prevent it from slipping off the sender unit. Label each wire.

Fit the other connector to the oil pressure sender unit, which is located above the oil filter. Note the black heat shrink tag – this sender unit also measures the resistance to earth.

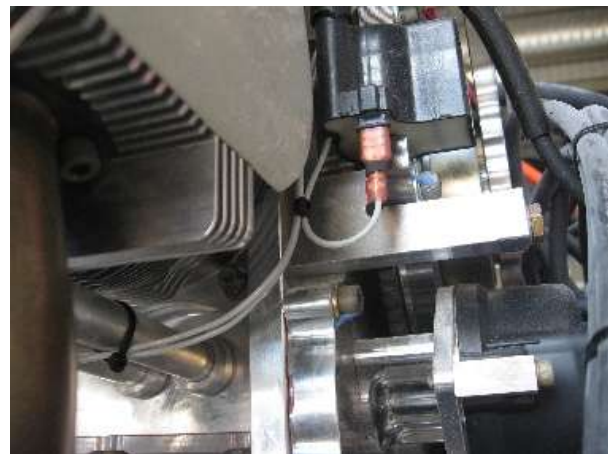

Route both wires back under the cylinders and zip tie them to the pushrod tubes – you will need to bend the zip ties into a “U” shape first in order to fit them around the pushrod tubes.

In the photos above you can see the 2 wires running back under the pushrod tubes and then up behind the rear cylinder. You can also see the earth wire from the left magneto (with a black tag again because it is used to earth the magneto to turn it off). These wires will all need to be long enough to be routed around the rear of the engine and 300mm into the cabin.

Fit the tacho sender unit

For this step you will need to rotate the engine, which may cause 1 or 2 of the sealing plugs to pop off of the exhaust pipes and possibly some preserving oil may drip out, so place some rag under the engine until this step is complete. You will require a lever to turn the engine – in our factory we use a tool that fits onto the propeller flange.

Rotate the engine until a tacho timing tag can be seen under the tacho sender mount (the threaded fitting at the left rear of the engine) - refer to the photo at right for detail.

Remove one lock nut from the sender unit and screw it into the fitting, then carefully screw it down until it *just* touches the timing tag. Unscrew the sender unit one full turn and tighten the lock nut finger tight.

Now rotate the engine one half of a turn until the other timing tag is under the sender unit and screw the sender down until it *just* touches that tag, which should be one full turn. Back the sender unit out one half of one turn and firmly but carefully tighten the locking nut.

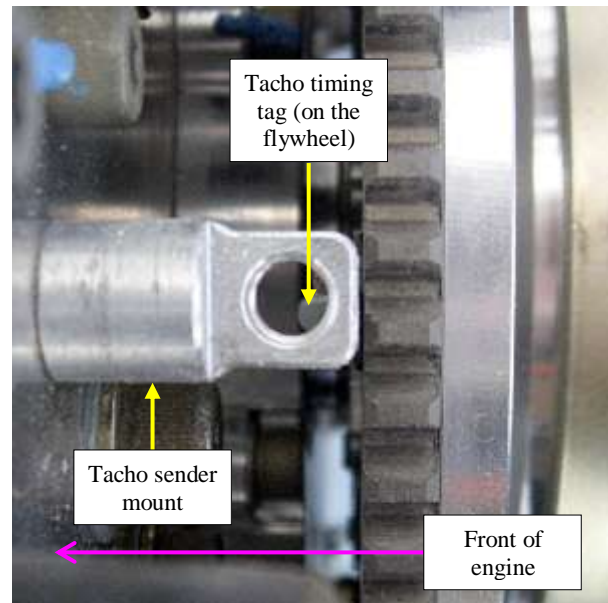

Wire the magnetos

Feed a plain length of 16 gauge wire through the hole in the side of each magneto, strip 4mm of insulation off and crimp a red female spade connector to the wire with a black heat shrink tag. A black tag is used because the magneto wire is used to earth the magneto to turn it off.

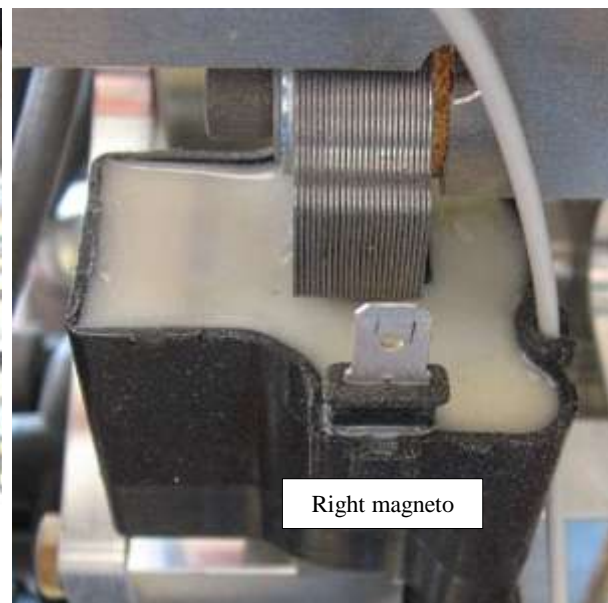
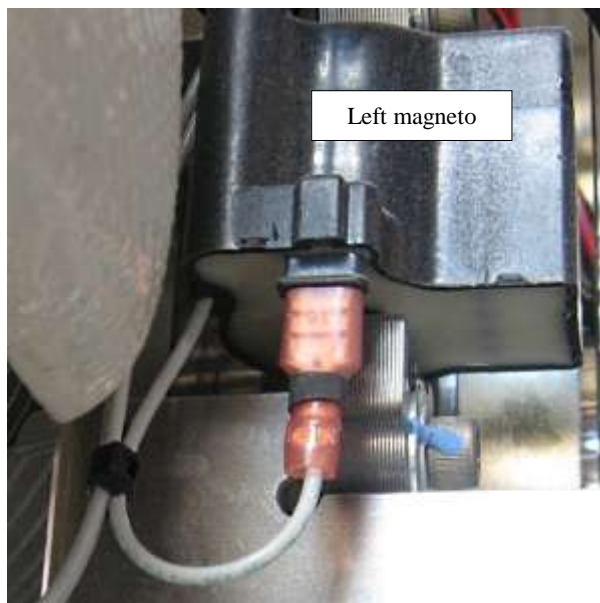

Fit the CHT (Cylinder Head Temperature) plug and wiring

Zip tie the CHT connecting plug to the front of the left hand top engine mount with the high temperature wire facing back. The sensor will be fitted to the left rear spark plug later in this task. The main photo on the next page shows the CHT connecting plug fitted.

Engine wiring routing

Cut the zip ties that hold the alternator wires to the engine and bend the wires to the right.

At this stage you will have wires at the top left rear of the engine for oil pressure and temperature, left magneto, CHT and tacho. Group these wires and zip tie them as shown at right, so you will have 3 white 16 gauge wires (oil pressure, oil temperature, left magneto) and 2 pairs of red and black wires (CHT and tacho).

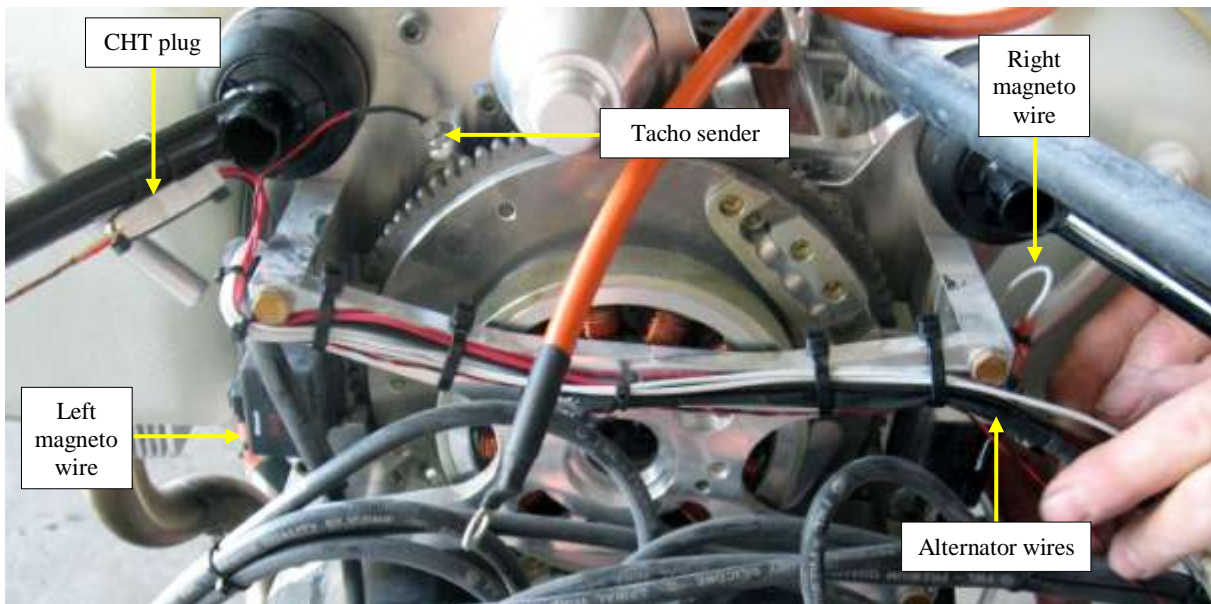

Now run the wires across the machined aluminum beam behind the flywheel as shown above.

Add the alternator wire pair into the group as shown, but before you do, twist the wire pair several times so that there are no lengths where the wire pair is straight—the full length of the alternator wires should be twisted. This will help to minimize inducing noise into the wiring harness from the alternator.

From here the wiring bundle can be routed up to the top right engine mount and then back along the mount tube to the firewall. Include the right magneto wire in the wiring bundle at this point.

The 16 gauge wires for oil pressure, oil temperature, left and right magnetos, CHT and Tacho can all be passed through the right hand cable collar in the firewall and 300mm left free inside the cabin for later fitting to Connector **A**.

If you are using the optional fuel pressure sensor it can be connected at this time and the wires included in the wiring bundle for later fitting to Connector **B**.

The 2 wires from the alternator can be routed along the firewall and down to the regulator plug for connection in the next step.

Don't zip tie the wiring bundle to the engine mount just yet - there are some more wires to be added to the bundle over the next few steps.

Wire the regulator connector

Power from the alternator will go to the regulator through the regulator connector, and power from the regulator will go to the positive and negative sides of the battery as well as the power to the main bus and to the optional low voltage warning light, also through the regulator connector.

Crimp a male spade connector to each of 2 x 1m lengths of 16 gauge wire and plug them into the female connectors from the alternator. Cover each connector with heat shrink tubing. Route the wires into the wiring bundle that runs along the top right-hand engine mount, around the firewall and down to the regulator connector.

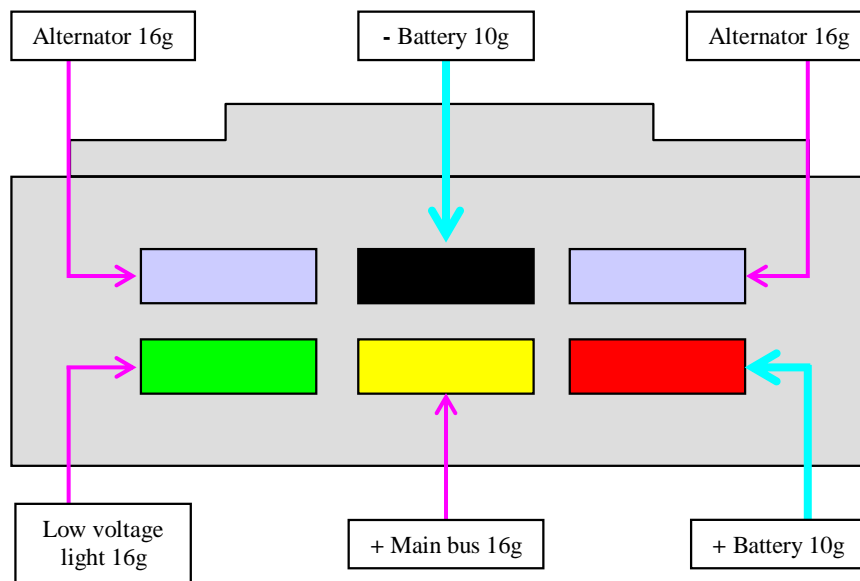

Wire the male half of a QK6 connector as shown above – note that the positive and negative wires to the battery are both 10 gauge (heavier) wire, shown above as light blue, while the rest are all 16 gauge (lighter) wire, shown above as purple.

The colour coding of the pins in the diagram above indicates the colour of the wires coming from the regulator to the connector.

Route the 10 gauge positive wire from the red pin to the front post on the starter solenoid.

Route the 10 gauge negative wire from the black pin to the earth terminal on the firewall.

Route the 16 gauge wires from the yellow pin to the main bus and from the green pin to the optional low voltage warning light - pass both wires through the right hand cable collar in the firewall and leave 300mm free inside the cabin for later fitting to Connector **B**. Carefully label each wire with masking tape.

Once you have allowed enough wire length to enable routing in a tidy manner, strip 4mm from the end of each wire, carefully crimp a female spade connector to each wire, and then fit each connector carefully into the connector housing.

Refer to the *Engine bay wiring routing* step later in this task for an example of how to route the wires from the Regulator plug to the battery and the cable collar.

Wire the starter solenoid

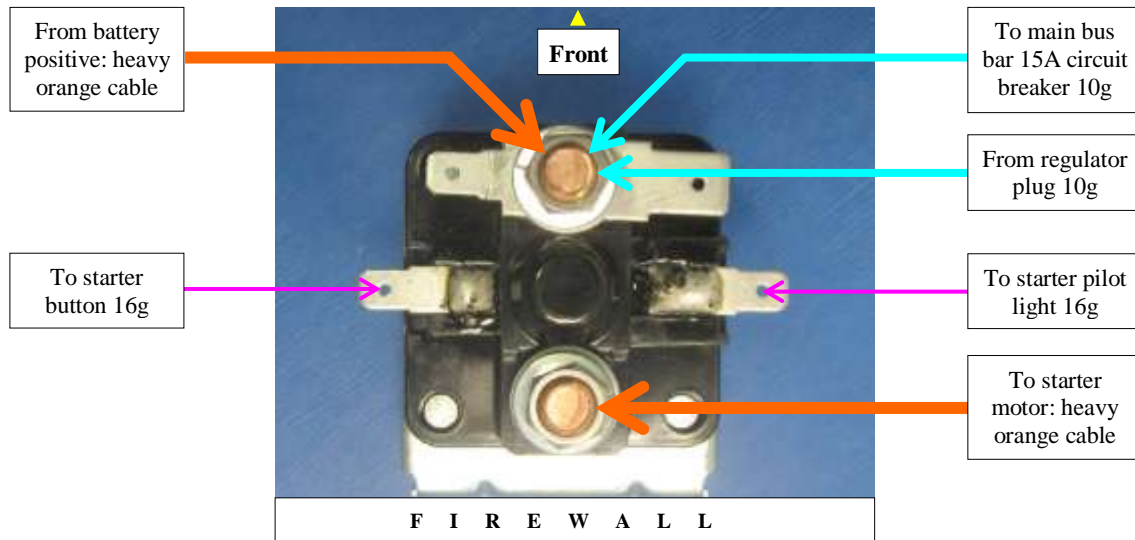

Route the short heavy orange cable from the positive side of the battery to the front post of the starter solenoid. Fit an 8mm yellow ring terminal and a red heat shrink tag to each of 2 lengths of 10 gauge wire (shown above as light blue) and route one wire to the red pin in the regulator plug and the other wire from the front post to the main bus 15A circuit breaker: pass the wire through the right hand cable collar in the firewall and leave 300mm free inside the cabin for fitting to Connector C.

Fit a red female spade connector and a red heat shrink tag to 2 x 1m lengths of 16 gauge wire (shown above as purple) and route one wire from the left-hand middle connector on the solenoid to the starter button and one wire from the right-hand middle connector to the starter pilot light - pass both wires through the right hand cable collar in the firewall and leave 300mm free inside the cabin for fitting to Connector B.

The large and small spade terminals on the front post of the starter solenoid are not used.

Connect the starter motor

Earth the starter motor by fitting the long heavy orange cable under the top bolt that holds the front of the starter motor housing in place – this provides maximum current to the starter unit. Loosen both starter bolts slightly and then remove the top bolt and fit the cable under it. Apply a drop of Loctite and retighten both bolts firmly. Route both orange cables back along the top right engine mount strut.

The positive cable (the one that goes inside the starter motor) can be fitted to the rear post of the starter solenoid and the earth cable can be fitted to the negative side of the battery.

Wire the firewall earth tag

The following 3 x 10 gauge wires are fitted to yellow 6mm ring terminals with black heat shrink tags and connected to the firewall earth tag with a single AN3-5A bolt and Nyloc nut:

1. The negative wire from the black pin in the regulator plug;
2. The negative wire to the earth bus - pass this wire through the right hand cable collar in the firewall and leave 300mm free inside the cabin for later fitting to Connector C;
3. The negative wire to the negative post of the battery. Do **not** connect this wire to the battery at this time.

Engine bay wiring routing

The engine wiring bundle can now be zip tied to the right top engine mount and then the starter cables and the breather tube can be zip tied over top of those wires. Take some time to route all of the wires neatly and zip tie any loose wires together. When all wires have been zip tied you can trim off the excess ends of the zip ties.

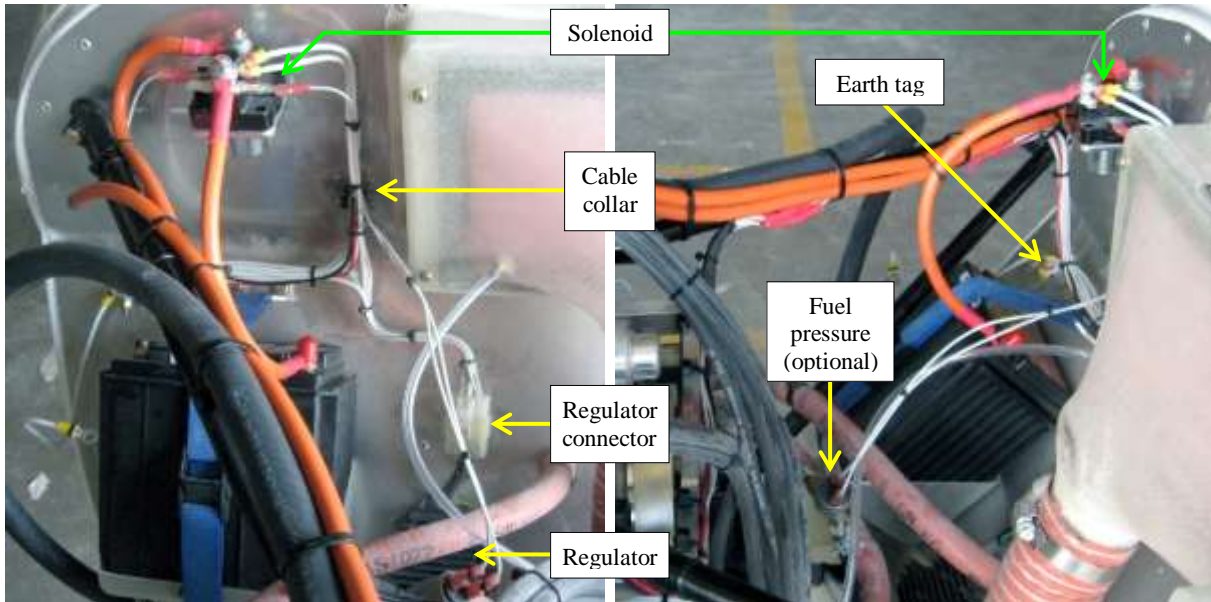

In the photos above you can see the general arrangement of the engine bay wiring.

Wire the strobes (optional)

Fit the strobe unit to the left side step on the firewall and feed all of the strobe wiring through the left-hand cable collar in the firewall – this separates the high voltage strobe wiring from the low voltage signal wiring that passes through the right hand cable collar.

Connect the strobe power supply wiring to Connector **E** and connect the strobe output wiring to the strobe wires that were fitted in the *Pre-Paint>Fuselage>Fit control cables and lines* task. Fit the strobe unit to the top of the fin and connect the wiring.

Wingtip strobe units will be connected after the wings have been fitted to the fuselage.

Seal the cable collars

Once all wiring has been routed through the 2 cable collars, each collar must be sealed with automotive exhaust sealer putty, which is available from any auto supply shop.

Push the putty into the cable collars from the firewall side until it can be seen inside the cabin and then smooth both sides off with your thumb. This will provide a fire resistant plug seal that will delay an engine fire from reaching the cabin through the cable collars.

Connect the high-tension leads and CHT sensor

Remove the ram air ducts from the cylinder heads. Remove the left rear spark plug and fit the CHT sensor under the plug. Refit the spark plug.

The high-tension leads are zip tied in pairs and grouped for each side of the engine, and the lengths of the leads are such that each pair will only fit properly to one cylinder. Test fit the leads with the ducts off, and then feed them through the rubber grommet in the rear of each duct and push the spark plug leads firmly onto the spark plugs. Replace the ram air ducts.

Wire the fuel pump

Two fuel pump wires were fitted through the console to the fuel pump in the *Pre-Paint>Fuselage>Fit control cables and lines* task: one wire will be the positive and one wire will be the negative or earth to the fuel pump. Determine which wire will be the positive wire and which will be negative or earth wire and label each end of each wire with masking tape. The forward or firewall end of both wires will be fitted to Connector **D**.

Route the firewall end of both wires so that there is enough length for Connector **D** and then trim the rear ends of both wires so that they end beside the fuel pump.

Fit a red female spade connector and a red heat shrink tag to the positive wire and a red male spade connector and a red heat shrink tag to the red wire from the fuel pump. Connect the positive wire to the red wire from the fuel pump.

Crimp one 4mm ring terminal with a black heat shrink tag to each of the following wires:

1. The negative or earth wire from Connector **D**;
2. The black wire from the fuel pump;
3. A 100mm length of 16 gauge wire – this will earth the header tank quick drain:
4. 2 lengths of 16 gauge wire 100mm longer than the fuel lines – these wires will earth the wing tank quick drains. Crimp both wires into the one ring terminal.

Drill a 4mm hole through the floor near the fuel pump and fit a 4mm countersunk screw with a Tinnerman washer from under the fuselage, then place all 4 ring terminals over the screw and secure them with an M4 Nyloc nut and washer. Tighten firmly. This will ensure a secure fixed earth point for the entire fuel system that cannot accidentally become disconnected.

Feed the 100mm length of 16 gauge wire under the header tank, out of the quick drain hole and through a small hole in the side of the quick drain fairing, trim to length and fit a 4mm ring terminal with a black heat shrink tag and fix to the side of the quick drain fairing with a stainless steel self tapping screw as shown at right.



Run a length of twisted lock wire from the quick drain fitting to the same point, fit a 4mm ring terminal with a black heat shrink tag and connect it under the same self tapping screw as shown above. This will lock the quick drain fitting in place and also earth the header tank.

Run the wing tank earth wires along the outside of the protective sheath with the fuel lines to the wing tanks and zip tie the wires in place. These wires will be connected when the wings have been fitted. Label both wires [Earth] with masking tape.

Wire the flaps and optional landing lights

Run a pair of 16 gauge wires from the firewall through the console, along the back of the front seats and up behind the door to the flap motor. Fit male and female spade connectors to connect to the flap motor.

Landing light wires follow the same path through the console and are then routed out through the floor and up inside the left hand wing strut.

Label each pair of wires for later fitting to Connector **D**.

Fuel gauge wiring from the wing tank fuel gauges

Before completing the upholstery around the windscreen the 2 wires from the wing tank fuel gauges must be routed down the windscreen pillars.



Drill a 5mm (arrowed above) hole slightly in front of the forward wing mounting lug on each side and feed 2 wires out of the hole and back towards the rear wing mounting lug as shown above and tape them to the fuselage.

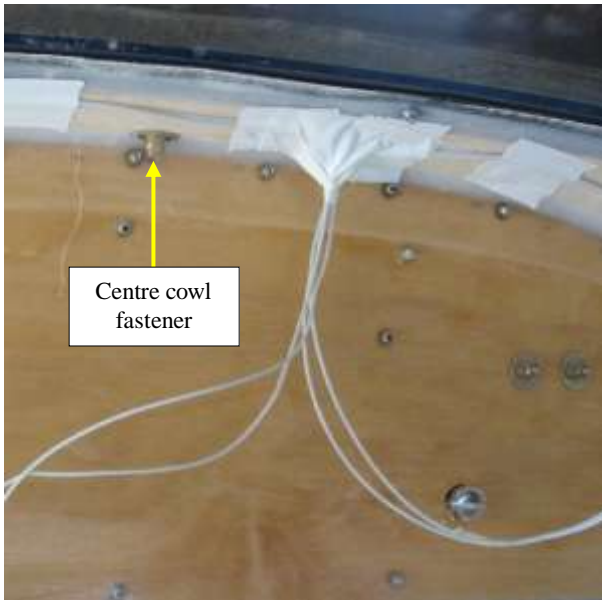

Run the inside portion of the wires down the windscreen pillar, holding them in place with short lengths of cloth tape as shown above right. The wires from both sides need to meet slightly to the right of centre as shown above left.

Leave the wires hanging down about 300mm and make sure that the wires from each side are clearly labeled [Left] and [Right] – use masking tape to label them. There is no polarity requirement for these wires. These wires will be fitted to Connector **E**.

Note that these wires are quite separate from the wing tank earth wires that were fitted earlier.

The upholstery strips can now be glued into place to cover the wires – refer to the *Post-Paint>Fuselage>Upholstery 1* task for detail. In the factory we place these wires before the upholstery is fitted, which is shown in the photos above, however you could equally install all of the upholstery apart from the windscreen strips and then fit them once the wires have been placed.

The top ends of these wires will be connected to the wing tank fuel gauges when the wings have been fitted to the fuselage. Leave them taped to the fuselage until then.

Connect the multi pin connectors

Each wire inside the cabin has been labeled with masking tape as it was fitted in order to clearly identify where it came from. If any wires have not been labeled then use a circuit tester to trace the wire to its source and then label it clearly.

Use the multi pin connector diagrams from the *Assemble instrument panel* task to sort and group the wires for each connector together. Trim each group to an even length, then strip 4mm from the insulation of each wire and fit the appropriate connector type to each wire: *male* spade connectors for a *female* connector body and *female* spade connectors for a *male* connector body.

The connector bodies that will be used are the matching halves of the connectors that were used in the *Assemble instrument panel* task – these were store at the completion of that task.

Use the connector diagrams and pin numbering assignments from the *Assemble instrument panel* task to very carefully fit each spade connector into the connector body until it clicks into place in the same manner as you did in the *Assemble instrument panel* task.

Take your time with this step – the wiring to each pin **must** be absolutely correct!

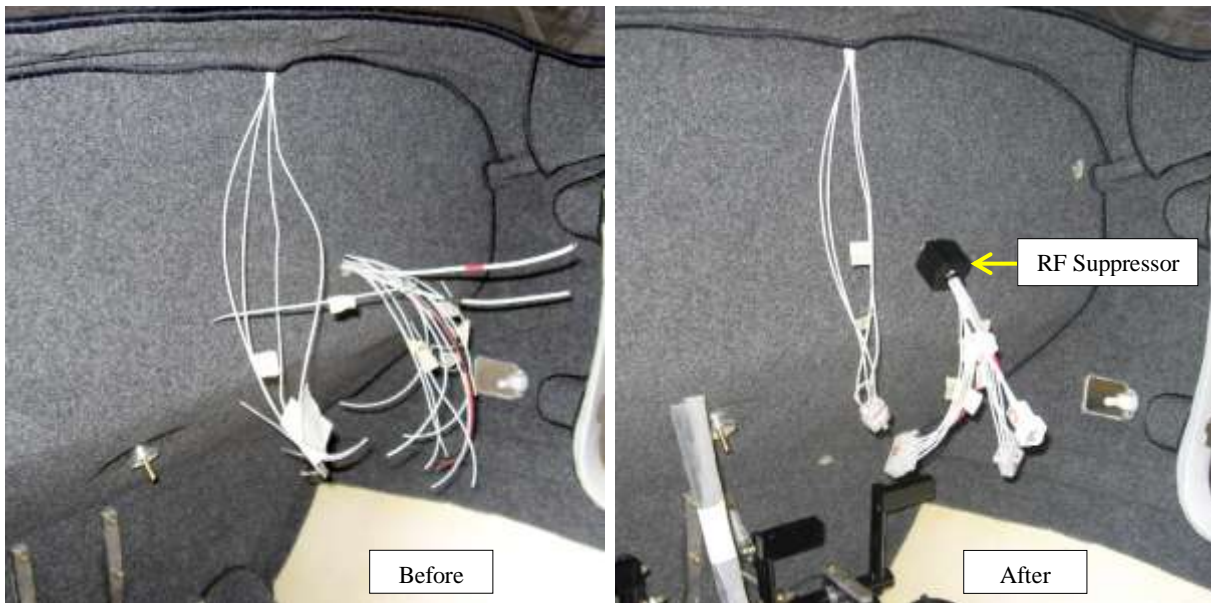

Notice the clear labeling of each connector in the photo above right.

Clip a ferrite RF Suppressor (shown opened at right) around each wiring bundle as it exits from the cable collar in the firewall, taking care not to crush any single wire when you clip it shut.

Use a zip tie around the wiring bundle to hold the RF Suppressor from sliding down the wires.

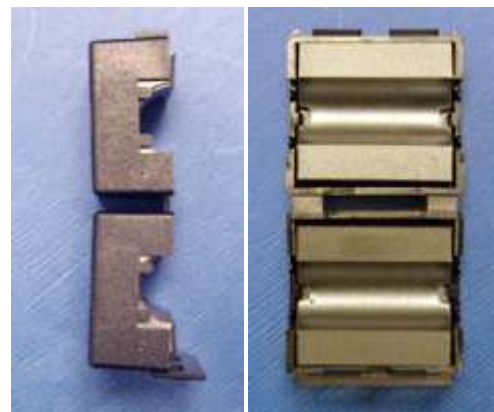

Fit the VHF radio wiring harness

The Aircraft Harness pack includes the wiring harness and all of the necessary hardware: the Push To Talk (PTT) buttons for the control stick and the headset jacks for the top of the cross beam outboard of the seat backs. All wires are clearly labeled and the headset jacks are colour coded as well for ease of installation. The harness goes through the console and exits in 2 places: the PTT wires exit under the control stick and the headset wires exit each side of the console behind the seats. The multi-pin plug connects to the digital harness behind the panel so leave the plug about 400mm above the console. Note that in all cases the grey wires are the earth wires.



Use a flexible rod inserted from the access hole behind the seats to draw these wires back through the console, then work through the access hole in the side of the console to feed the control stick PTT wires only around and out of the hole under control column as shown arrowed below right. Fit a rubber grommet to the hole first to prevent chafing of the wires.

For a dual stick: feed both groups of PTT wires up and into the left underside of the control stick, taking the Pilot group up the left hand side and the Co-Pilot group up the right hand side.



For a single stick: feed the Pilot group up and into the stick and route the Co-Pilot group into the right seat base. You will need to cut an access hole under the right-hand seat in this case.

Both groups contain 2 pairs of wires: the blue and gray wires are for the PTT button while the green and gray wires are for the optional remote memory feature. Route the wires as shown in the photo at right, leaving enough room for full and free movement of the control stick.

Fit the wires to the PTT buttons and push the PTT buttons into the top of the control stick, or in the case of a single stick fit the Co-pilot's PTT into the front of the right seat base.

Separate the pilot and co-pilot headset wires (both sets are labeled as shown at right) and route them out of holes in either side of the console across behind the seat back to the jack locations. Strip the ends of the wires and solder them to the tags on the jacks, (the jacks are colour coded to match the wiring) and then fit the jacks into place.

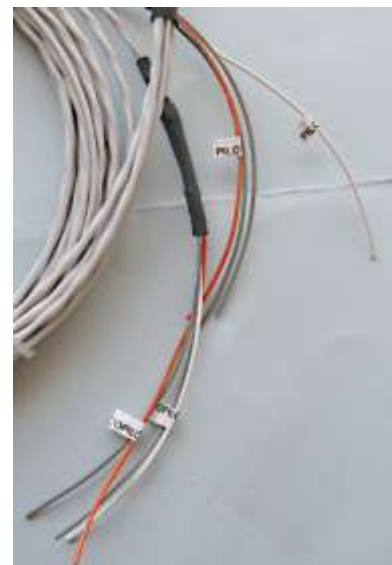

We suggest that you mount the jacks in the top of the beam between the seat back and the side of the fuselage. This tends to keep the headset wires out of the way in flight.

Zip tie the wires up under the rear lip of the beam – drill 3 holes along the bottom of each seat back for the zip ties.

Connect the VHF antenna cable

The VHF coaxial antenna cable was installed in the *Pre-Paint>Fuselage>Fit control cables and lines* task and connected to the VHF antenna in the *Pre-Paint>Fuselage>Empennage>Fit vertical tail fin* task. Trim the cable off level with the top of the firewall and fit the BNC connector that is supplied with the wiring kit (fitting instructions are included).

Fit the transponder encoder, antenna and cable

Start by mounting the encoder unit to the firewall with the connecting plugs end facing downwards – the encoder unit attaches to a base (both shown at right) with a thumbscrew so the base can be mounted to the firewall with 3 stainless steel self-tapping screws and then the box is fitted into it. Make sure that the encoder will mount above the throttle shaft and not foul the back of any instruments when the panel is fitted.



The static line up from the console will need to be branched with a “T” piece to connect to the encoder before connecting to the other static instruments.

Fit the supplied wiring harness plug to the encoder unit, tighten the plug retaining screws by hand and leave the other end free for later connection to the transponder unit when the instrument panel is fitted.

Mount the transponder antenna under the fuselage (shown fitted below right)– you will need to drill a 22mm hole through the floor of the aircraft on the centerline 415mm back from the base of the firewall. The antenna must be mounted facing down with the ground plane (the large round plate) fitted against the fuselage and held in place with the antenna flange. Smear the top of the ground plane with white silicone sealer before fitting to seal it to the fuselage.

The retaining nut and washer can then be fitted from inside the fuselage – you will have to work inside the front section of the console for this step.



Tighten the retaining nut firmly: do not over-tighten, then wipe away any excess silicone sealer that may have squeezed out from around the ground plane.

Connect the supplied coaxial antenna cable to the back of the antenna and route the cable out of the console and up the firewall for later connection to the transponder unit when the instrument panel is fitted. Route the coaxial cable so that all bends are gentle and take care to avoid crushing the coaxial cable in any way.

This completes the *Post-Paint>Fuselage>Install electrical wiring* task.

Post-Paint>Fuselage>Interior>Fit console controls

Objectives of this task:

To fit all of the console controls: the control stick, elevator trim and brake system.

Materials required:

Card # J17 'Elevator System and Control Stick'

Card # J8 'Dual Brakes'

Card # J2 'Trim System'

Control stick

Fit the 2 eccentric aileron stops to the rear end plate with 2 Allen head cap screws as shown at right.

The control stick should still be partly assembled from the *Pre-Paint>Fuselage>Interior> Console>Fit Control Stick* task. Clean any debris from the front and rear bushes and apply a small amount of lubricant to the bushes. Fit the control shaft into the console from the front, wipe away any lubricant from the rear of the control shaft and fit the aileron bellcrank to the rear of the shaft with an AN3-16A bolt and Nyloc nut, with the bolt fed up through the bellcrank.

Refer to the drawing on the next page for detail.



Fit the control stick to the pivot plate with an AN3-13A bolt, taking care to fit a flat nylon washer on each side between the stick and the plate. Connect the elevator cable rod end to the control stick with an AN3-21A bolt, spacer, 1/4" flat washer and a Nyloc nut as shown in the photo above and in the drawing on the next page.

Check for full and free movement of the control stick.



ITEM	PART NUMBER	DESCRIPTION	QTY
1	1007094-4	BUSH - CONTROL COLUMN	1
2	3A08180D-1	CENTRE STICK PIVOT SHAFT	1
3	3A02660D-5	DOUBLE CENTRE STICK PIVOT PLATE	1
4	3117094-2	POLYURETHANE WASHER - 10mm ID, 25.4mm OD, 1 THICK (NOT DRAWN)	2
5	3000C84-5	SPACER CENTRAL PIVOT	4
6	AN860-10	3/16" FLAT WASHER	9
7	MS20365-1032	3/16" NYLOC NUT	5
8	AN3-13A	3/16" BOLT	3
9	AN3-21A	3/16" BOLT	1
10	AN3-16A	3/16" BOLT	1
11	AN860-416	1/4" FLAT WASHER	1
12	P800194	3/16" FEMALE ROD END	1
13	PM0058N	END CAP	2
14	PM0038N-cut	RUBBER HAND GRIP	2
15	3A026F0D-6	DOUBLE CENTRE STICK HANDLE ASSY	1
18	P10062N-1	P/T SWITCH (SPST MOMENTARY ON, 3A, 125V/1A, 250V)	2
19	3A087D0D-2	AILERON BELLCRANK INBUILT STOPS	1
20	3A087A0D-1	ASSY - CONTROL SHAFT END HIGH AIL STOPS, SKF BEARING	1
21	MS36207-267	SCREW 10-32 X 3/4	2
22	AN316-3	3/16" NUT	2

PROJECTION GENERAL TOLERANCES: HOLE NO. ±0.05 ONE DEC. ±0.25 (ON DEC. ±0.05 ANGLES ±0.5°) MATERIAL: REFER TO PART DRAWINGS	DIMENSIONS IN MILLIMETRES	DO NOT SCALE DRAWN: JW APPR.:	AVTECH P/L A.C.H. 810 788 873 HINKLER AIRPORT BUNDBERG 4670	THIS DRAWING IS COPYRIGHT AND MUST NOT BE COPIED WITHOUT THE CONSENT OF AVTECH PTY LTD TITLE CONTROL STICK ASSY J160 HIGH AILERON STOP SCALE NTS ISS. DATE 1 25/05/08 ISS. DATE 2 20/11/08 ENG. No. 3A081A0D-4 SHEET 1 OF 1 IA3
--	-------------------------------------	--	---	--

Brake system

Cut a short length of sheet aluminium the width of the brake lever slot and about 40mm in length. Bend the aluminium strip in half, apply a smear of Araldite inside the bend and crimp it to the front of the brake lever slot – this is the bearing surface for the brake lever cam.

The brake lever should still be assembled from the *Pre-Paint>Fuselage>Interior>Console>Pre-Fit Handbrake* task: fit the brake lever mount bracket to the front inside of the console and secure with 2 x ¼” by ½” UNC Allen head cap bolts and flat washers. Fit the lever into the bracket with an AN4-11 bolt and castle nut, with a thin flat washer on each side of the lever, tighten the castle nut firmly and lock it in place with a split pin.

Hint: a magnet will help you place the flat washers.

Refer to the drawing on the next page for detail.

Fit the master cylinder to the front of the console with 2 x ¼” by ¾” UNC Allen head cap bolts and fit the clevis to the bottom of the lever with an AN5-11 bolt and castle nut, tighten the castle nut firmly and lock in place with a split pin.

Drill a ½” hole near the top left of the front face of the console and feed the brake hose into the console then down and out of the hole behind the top of the main undercarriage legs. Fit a rubber grommet over the brake hose at the front of the console, blow the hose clear and fit it to the brass fitting on the master cylinder. Tighten the fitting firmly. Leave the brake hose about 50mm below the fuselage and trim off.

Fit a brass “T” connection to the hose, then run a length of brake hose down each main undercarriage leg to each brake assembly as shown in the photo at right. The short length of PVC tubing over the brake hose is to protect against chafing from the wheel spat. Zip tie the brake hose to the leg.

Check that all of the brake hose fittings are tight.

Fill the reservoir on the master cylinder with the recommended brake fluid, loosen the bleed valves on the wheel cylinder units (circled in yellow above) and slowly pump clean brake fluid through the brake lines.

Pay careful attention to the brake fluid level in the master cylinder reservoir during this procedure and keep the fluid level topped up, otherwise you run the risk of drawing air back into the lines, which would mean starting all over again.

When brake fluid reaches the wheel cylinders close off each bleed valve and then pressure bleed each wheel cylinder in turn until no more air remains in the brake lines and the brake lever feels firm and not at all spongy when pressure is applied.

When you are satisfied with the brake pressure, top up the fluid and replace the reservoir cap.

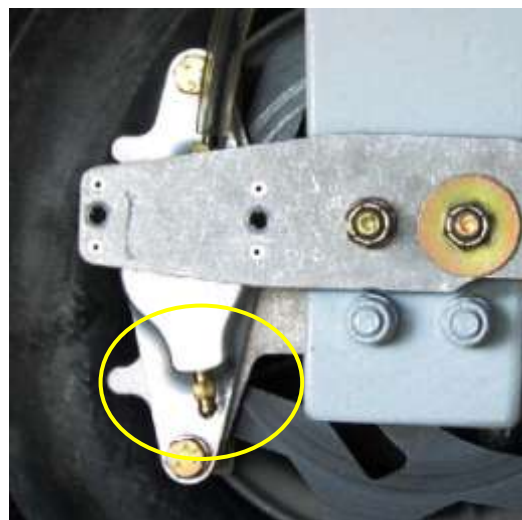

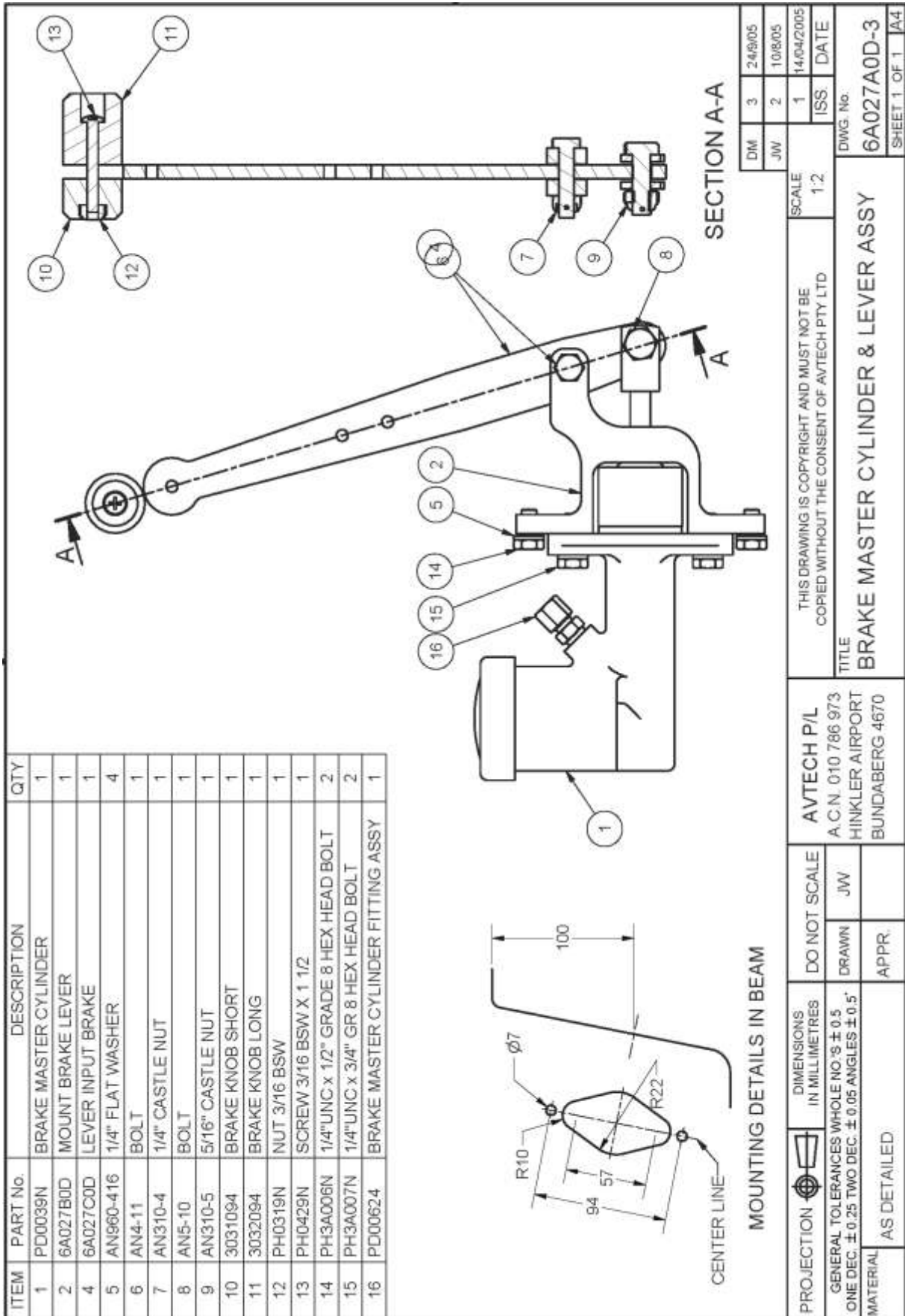

Elevator trim lever assembly

Connect the trim cable rod end to the left-hand trim lever with an AN3-10A bolt, 3/16" and 1/4" flat washers and a Nyloc nut. Clean any debris away from the trim bush and fit the trim shaft and levers, with soft washers under the levers, and secure the levers to the shaft with an AN3-35 bolt and castle nut. The castle nut should be fitted to the left-hand side of the console, tightened firmly and locked in place with a split pin as shown in the photo at right.

Check for full fore and aft stop-to-stop movement of the trim levers.

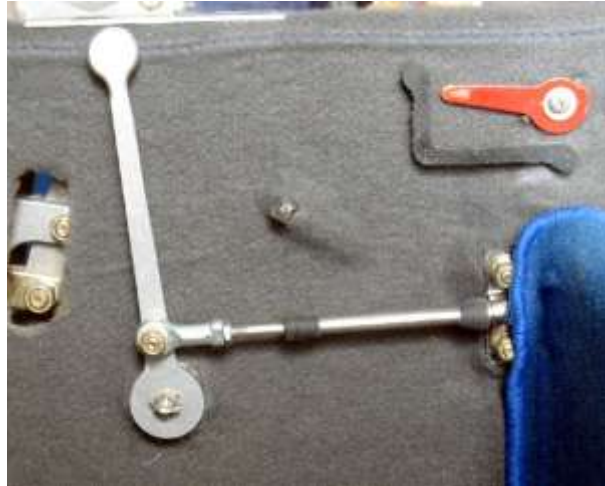

Pitot tubing

Use a flexible rod to draw a length of 1/4" ID PVC tubing through from the wiring access hole in the lower front of the console, through the console and out of the hole under fuselage where the brake line exits.

Leave enough length so that the top of the tubing is just below the bottom of the windscreen and so that the bottom of the tubing reaches across to the right-hand strut bushing.

The top end of the pitot tubing will be connected in *Post-Paint>Fuselage>Interior>Fit the instrument panel* and the bottom end will be connected once the wings have been fitted.

Fuel tap

Fit the red fuel tap handle to the fuel tap shaft as shown in the photo at right.

Position the "L" shaped plastic guard in front of and below the tap, drill holes for the end pegs and Araldite the guard into place.

Placards

Place the fuel tap placard behind the fuel tap.

Place the trim placard above the trim lever on top of the console with the front of the placard level with the front of the brake lever slot.

Place the brake lever placard behind the brake lever slot with the rear of the placard level with the rear of the trim placard.



This completes the *Post-Paint>Fuselage>Interior>Fit console controls* task.



Post-Paint>Fuselage>Interior>Controls>Fit rudder pedals

Objectives of this task:

To fit the rudder pedals and steering links to the aircraft, and fit the rudder cable to the rudder pedals and set the deflection of the rudder.

Materials required:

Card # J3 “Rudder”

Card # J19 “Noseleg” for the steering yoke

Fit the pedals

The rudder pedal assembly will be fitted to 3 sets of bearing blocks, 2 on the moulded floor mounts and 1 on the lower front of the console. Sit the pedals in the lower mounting blocks on the mounts and clean the front and back holes in the mounts with a 3/16” drill. There are captive nuts in the centre holes in each mount so do not drill any centre holes.

Apply a thin layer of grease to the half-round cutouts in the upper and lower rudder pedal blocks and then fit the rudder pedals into place in the lower blocks. Seat the pedal assemblies in the blocks and fit the upper blocks and clamp plates and secure with an AN4-25A centre bolt to each block to hold it in place. Check for minimal side-to-side movement.

Place a flat washer under the head of each bolt.

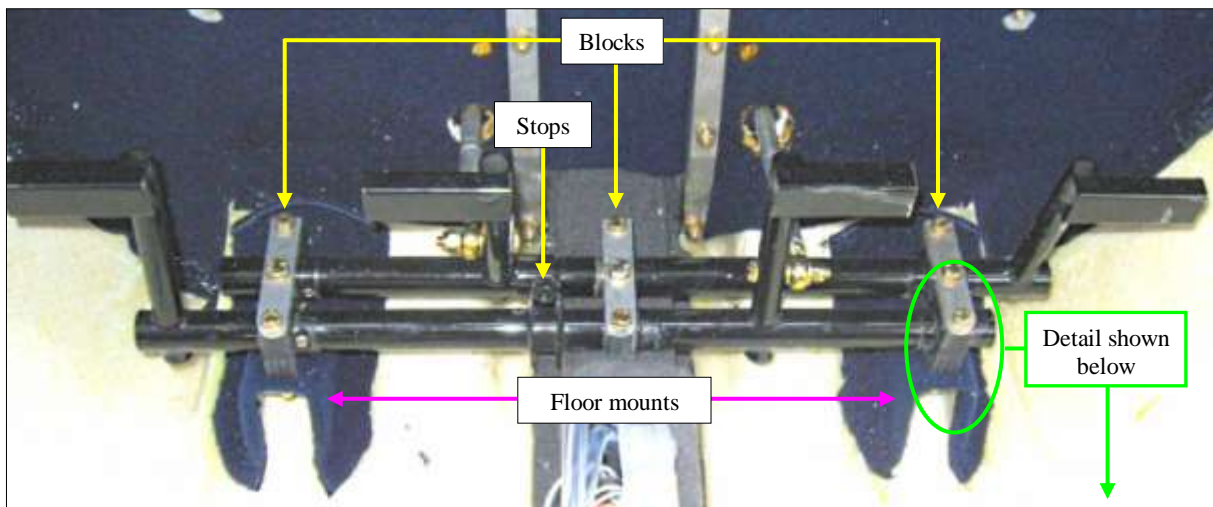

Now fit the bottom clamp plates in place inside the floor mounts one at a time: start with the front AN3-25A bolt and Nyloc nut – the front nut can be awkward to fit but if it is super glued to the plate then the plate can be held in place and the bolt can be threaded down into it.

Fit the rear AN3-25A bolt and Nyloc nut all as shown at right.

When all bolts and nuts have been fitted, tighten each nut to safety and then tighten the centre bolts down firmly.

Check for free fore and aft movement of the rudder pedals.

It may be necessary to adjust the tension on the bolts slightly if the pedals are binding.

Fit the 1/4” UNF Allen head cap screws through the pedal travel stops beside the pilot’s side right rudder pedal on the rear bar and fit 1/4” UNF plain nuts behind. These will be set later in this task.



Assemble and fit the steering yoke

Trim off the moulding lip from around the hole in the rubber bush with a sharp knife if required. Press the rubber bush into the smaller hole in the steering yoke as shown and apply a smear of grease to the mating surfaces between the soft connection link and the steering link. Press the spacer tube into the rubber bush.

Fit the steering assembly to the noseleg: have someone hold the tail of the aircraft down and lower the nose leg until the steering yoke and soft link can be fitted between the upper and lower bushes with the arms of the yoke facing rearwards. Lightly grease the top and bottom of the nose leg and then push the nose leg back up and lower the nose of the aircraft. Refer to the drawing below and the photos on the next page for detail.

Connect the soft link to the steering yoke with an AN4-16A bolt and large flat washer and secure with a washer and Nyloc nut and tighten the nut to safety. If nose leg is not drilled, then centre the front wheel so that it is pointed exactly straight ahead, move the steering yoke assembly so that both arms are an equal distance from the firewall and then drill a 3/16" hole through the hole in the soft link and all the way through the noseleg and fix the soft link in place with an AN3-22A bolt, washer and Nyloc nut and tighten the nut to safety.

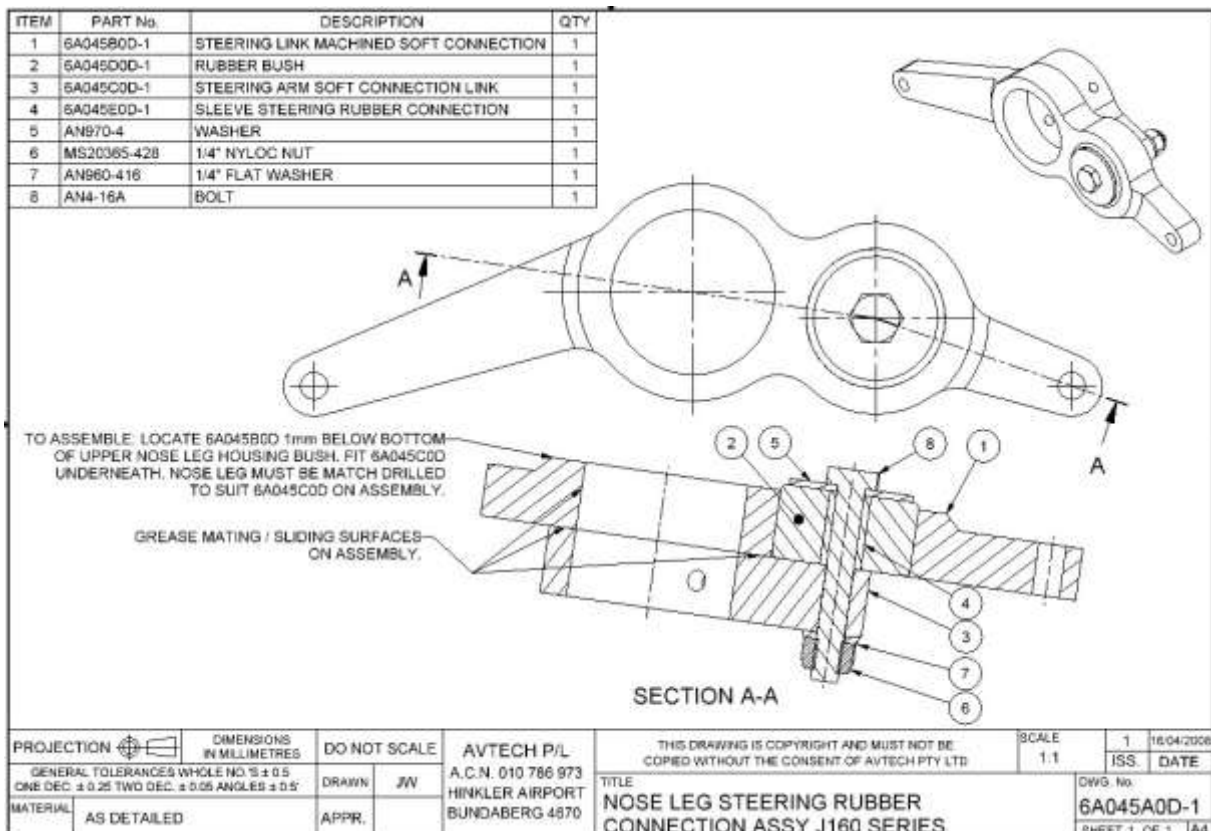
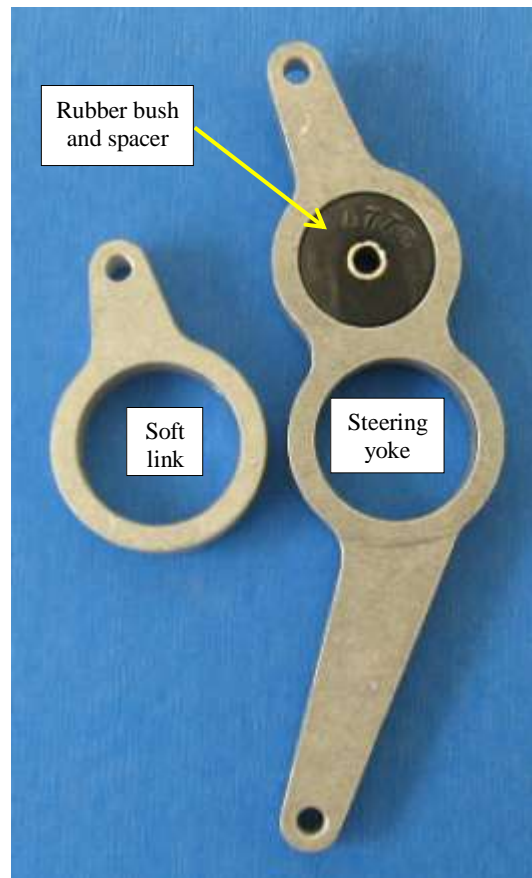

Fit the steering yoke and pushrods

Fit the retaining collar to the top of the nose leg with an AN3-22A bolt, washer and Nyloc nut and tighten the nut to safety. The nose leg is now final fitted as shown below.

Assemble the pushrods: thread a rod end with a plain nut to each end of each pushrod.

Do not tighten the nuts until the pushrod lengths have been adjusted.

Cut 2 rectangles of rubber sheet to approximately 30 x 50mm and punch a hole in the centre of each just big enough to pass the pushrod through. These are dust covers and they will be fixed to the firewall at the end of this task. Slip one over each pushrod for now.

The pushrods are different lengths: the longer pushrod fits to the right-hand side of the steering yoke and the shorter pushrod fits to the left-hand side of the steering yoke.

Fit the pushrods through the holes in the firewall and then connect them to the steering yoke with AN4-13A bolts.

Each bolt is fed down from the top of the yoke with an AN960-516 flat washer fitted under the head of the bolt, then the rod end and then a AN960-416L flat washer fitted between the rod end and the yoke and a regular AN960-416 flat washer and Nyloc nut fitted below the yoke as shown at right.

Tighten all of the Nyloc nuts to safety and mark each with *TorqueSeal*.

The dust cover is shown fitted in the lower photo, however it will not be final fitted until the end of this task, which is when this photo was taken.

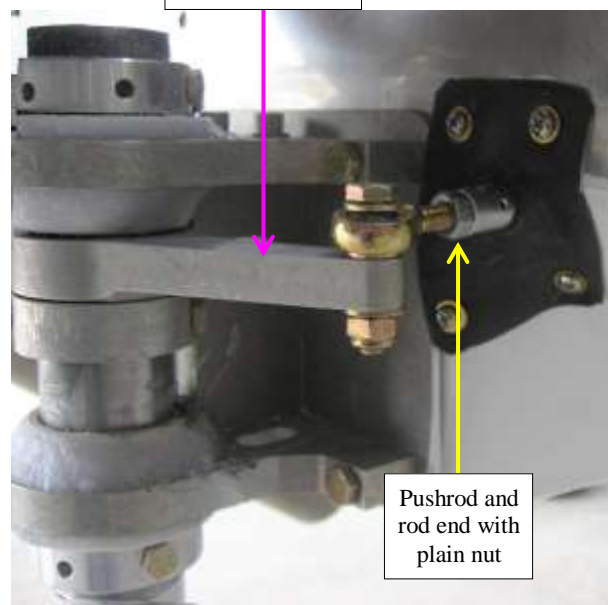
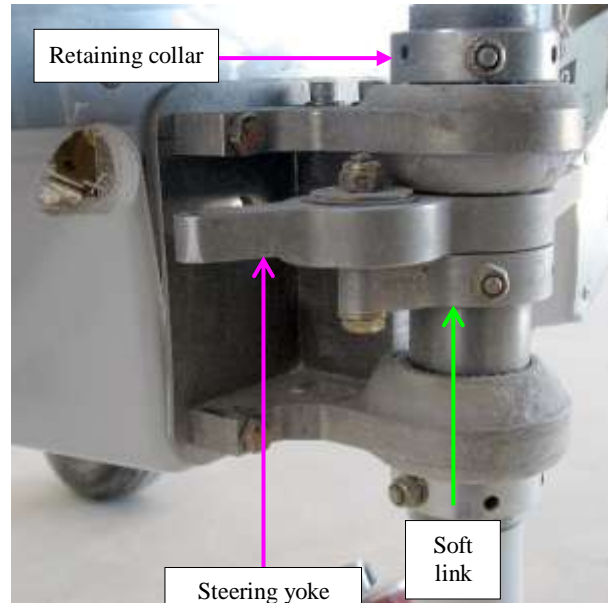



Adjust the push rod lengths and connect

Now the pushrods can be adjusted to length and connected to the rudder pedals.

Set the nose wheel so that it is facing straight ahead – move the aircraft back a few meters and then move it forward in a straight line so that the nose wheel is aligned correctly.

Set the rudder pedals so that the tops of the pedals are all in line when viewed from the side, as shown in the lower left of the drawing at the end of this task.

Adjust the length of the left-hand pushrod by screwing the rod ends in or out an equal amount at each end of the pushrod until the rod end lines up with the hole in the pilot's side right rudder pedal arm without altering the position of the nose wheel and then fit the rod end to the outside of the rudder pedal arm with an AN4-14A bolt through the pedal arm then an AN960-416L flat washer and then the rod end followed by an AN960-516 flat washer and Nyloc nut.

Repeat the length adjustment procedure for the right-hand pushrod, still keeping the tops of the rudder pedals all in line, then fit the rod end to the outside of the co-pilot's side left rudder pedal arm with an AN4-14A bolt through the pedal arm then an AN960-416L flat washer and then the rod end followed by an AN960-516 flat washer and Nyloc nut.

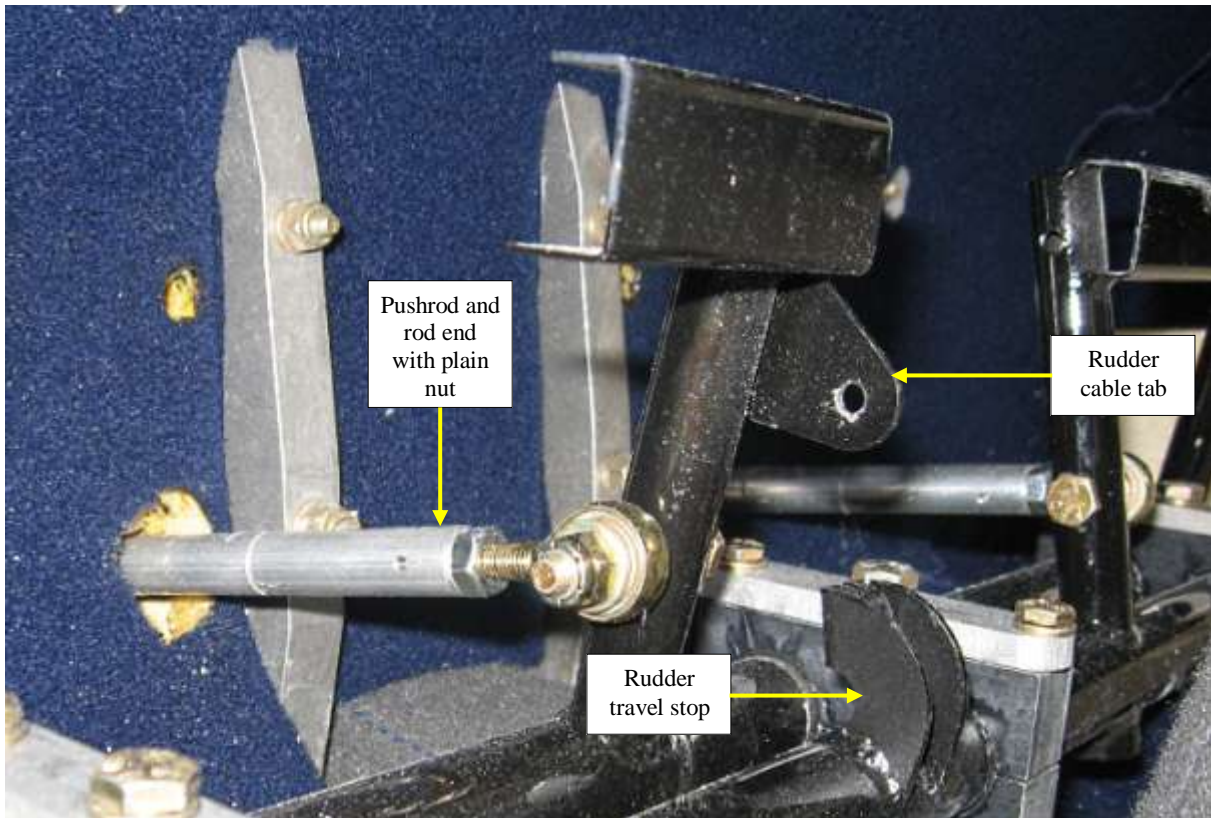

Check that the rudder pedals can move the nose wheel freely from side to side and make any fine adjustments that may be needed to have the tops of the rudder pedals all in line with the nose wheel tracking straight ahead.

When the final adjustments have been made then all the plain nuts on the rod ends can be locked off, all the Nyloc nuts can be tightened to safety and all nuts can be marked with *TorqueSeal*.

Connect the rudder cable

Clamp the outer cable to the inside front of the cable housing with the notched saddle clamp and backing plate and secure the clamp in place with 2 x AN3 bolts fitted from the outside of the cable housing and Nyloc nuts with flat washers under them. Tighten the nuts to safety.

Connect the rudder cable rod end to the right of the tab at the top of the pilot's side right rudder pedal (circled in yellow below) and secure with an AN4-6A bolt through the pedal tab then an AN960-416L flat washer and then the rod end followed by an AN960-516 flat washer and Nyloc nut. Tighten the Nyloc nut to safety and mark with *TorqueSeal*.

Move the rudder cable to half travel and then set the rear of the rudder to a position 5mm to the right of the aircraft centreline (refer to the photos at the bottom of this page that show a rudder position/deflection jig in place under the rudder) and hold it in that position with some cloth tape or have someone hold it in place for you.

Set the rudder pedals to the neutral position, with the nose wheel facing straight ahead and the pedals all lined up along the tops.

Position the outer cable so that it runs in as smooth a line as possible from the cable entry cut-out in the console to the rudder pedal tab and then mark and drill the 5 x 7/32" holes through the cable housing and into the console and rivet the cable housing (circled in green at right) to the console with 5 x 7/32" TLR rivets.



Adjust the rudder deflection

The rear of the rudder should be able to be move 78mm to the left and 78mm to the right from a neutral position that is defined as being 5mm to the right of the aircraft centreline.

This range of movement is controlled and limited by movement of the rudder pedals.



The photos above show a rudder position/deflection jig in place under the rudder.

The limits are adjusted by the rudder stop screws beside the pilot's side right rudder pedal: adjust the pedal travel by using the Allen head cap screws until the rudder deflection is correct. Lock off the Allen head cap screws with the plain nuts, recheck all deflections and mark the lock nuts with *TorqueSeal*.

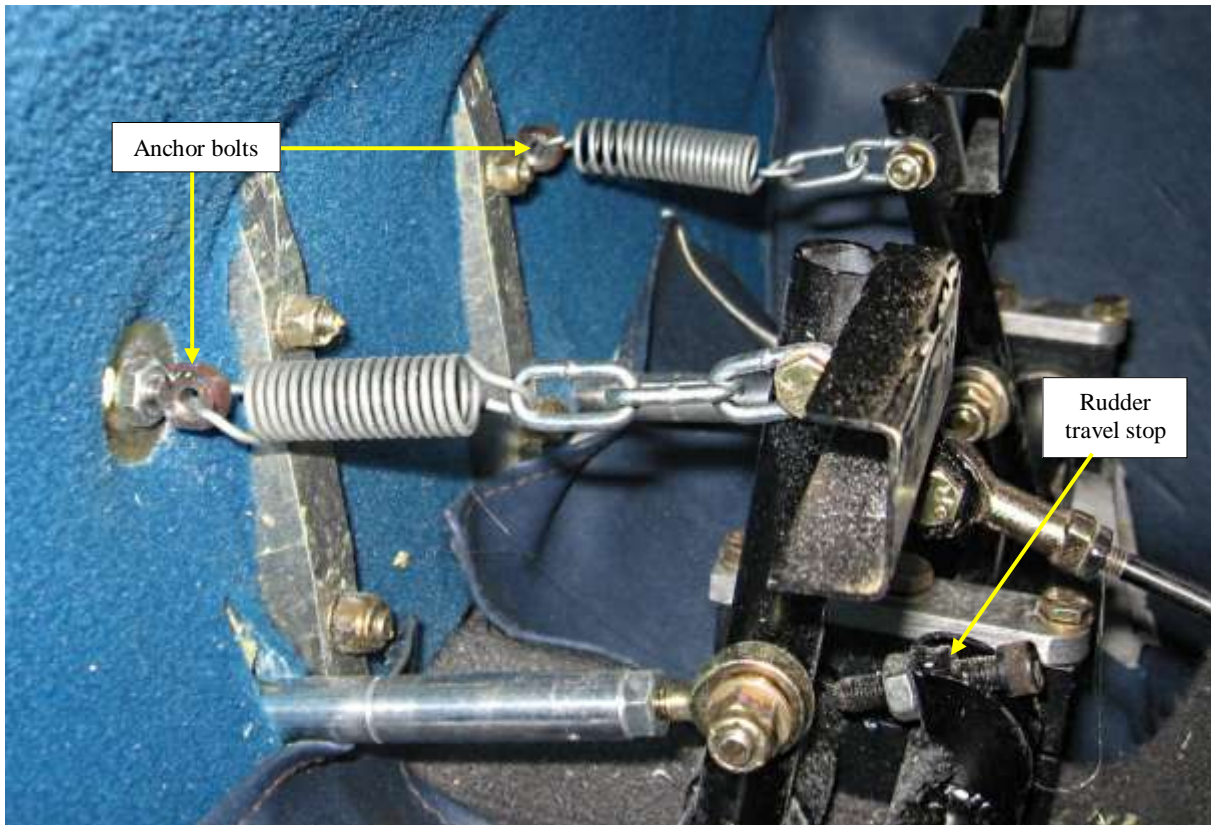
Fit the centring springs

The centring springs are attached by links of chain bolted to the top of the centre rudder pedals with AN3-11A bolts and then anchored to the firewall by means of anchor bolts – refer to the drawing at the end of this task for detail. Position the anchor bolts so that they are evenly spaced and then mark and drill 3/16” holes and fit the anchor bolts through the firewall with a flat penny washer each side and a Nyloc nut tightened to safety.

Fit the centring springs into place and use pliers to bend the hooked ends of the springs so that the springs cannot easily or accidentally be removed.

Adjust the spring tension by altering the length of the anchor bolts so that the nose wheel will return to centre when there is no weight on the nose wheel (hold the tail down to do this check). When adjustments are complete tighten the anchor bolt nuts.

Fit the dust covers

The last step is to fit the rubber dust covers into place – hold each cover so that it is square and level and fix it in place by means of either contact adhesive or small screws and washers.

The photo at right shows a dust cover fixed in place with silicone sealer and 4 small stainless steel self-tapping screws and flat washers.



The next page of this task shows a drawing of the rudder pedal and steering assembly.

Parts List			
ITEM	PART NUMBER	DESCRIPTION	QTY
1	3A04A00	RUDDER PEDAL ASSY - INBUILT STOPS, NO TOE BRAKES	1
2	P80112N	1/4" ROD END	4
3	3A062A00	PUSH ROD NOSE WHEEL LG J160	1
4	3A053A00	PUSH ROD NOSE WHEEL 130 LG J160	1
5	PH0238N	1/4" UNF NUT	4
6	AN960-416	1/4" FLAT WASHER	6
7	AN960-416L	1/4" FLAT WASHER	4
8	AN960-516	WASHER	4
9	MS20365-428	1/4" NYLOC NUT	4
10	AN4-13A	BOLT	2
11	AN4-14A	BOLT	2
12	6A031A00	RUDDER CENTREING SPRINGS ASSY (ON PEDALS)	2
13	6A033A00	ASSY - NOSE LEG TO MACHINED HOUSING, LOW STEERING YOKE	1

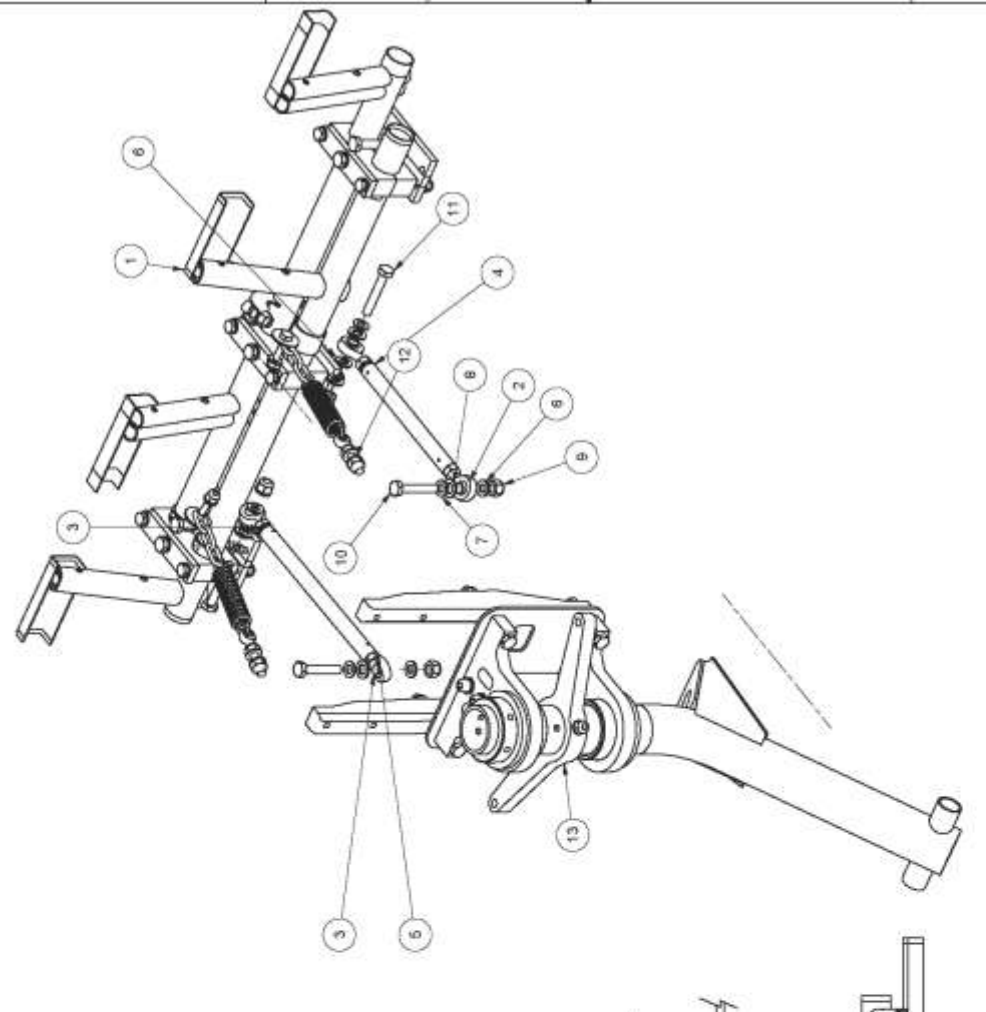
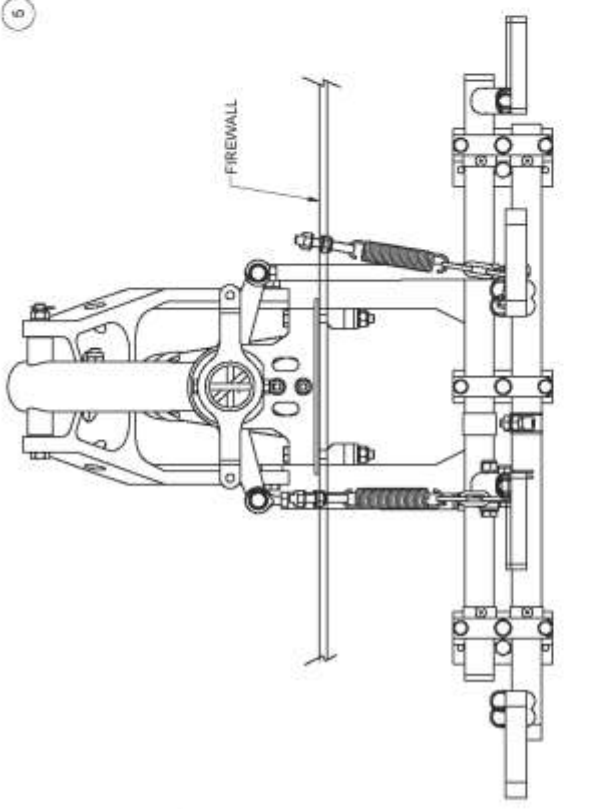
SCALE	1:10000
DATE	12/06/05
ISS. DATE	
DWG. No.	3A058A00-3
SHEET	1 OF 1

THIS DRAWING IS COPYRIGHT AND MUST NOT BE COPIED WITHOUT THE CONSENT OF AVTECH P/T LTD.	DO NOT SCALE DRAWN: DM APPR:	AVTECH P/L A.C.N. 010 788 873 HINKLER AIRPORT BUNDEBERG 4670
TITLE NOSE LEG STEERING / RUDDER CENTRING ASSY - J160 FAMILY		

This completes the *Post-Paint > Fuselage > Interior > Controls > Fit rudder pedals* task.

Post-Paint>Fuselage>Interior>Fit flap drive motor

Objectives of this task:

To fit the flap drive motor and actuating assembly.

Materials required:

Card J16 “Electric Flaps”

Epoxy resin and flock

Fit the flap shaft

Remove the inner flap drive arm from the flap drive shaft by removing the 2 x AN3 bolts and pulling the flap drive arm completely off of the shaft.

Feed the bare shaft into the cabin through the flap shaft mount in the top right of the cabin, first taking care that the bolt holes for the flap drive arm will end up on the left-hand side of the cabin, and slip the inner flap drive arm over the shaft before the shaft exits the cabin through the left side flap shaft mount.

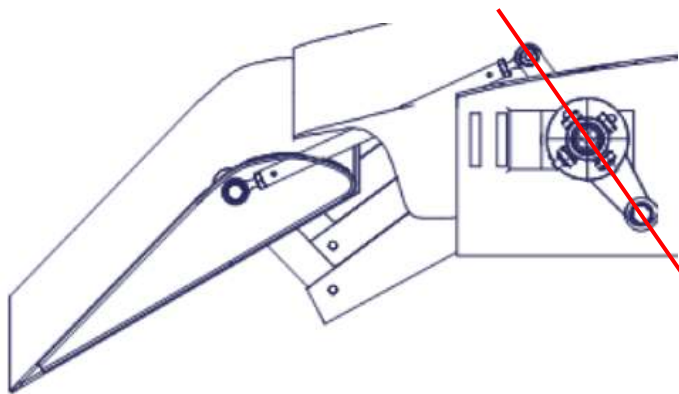

Ensure that the inner flap drive arm will be 180° away from the outer flap drive arms as shown above in red.

Refit the inner flap drive arm with the AN3 bolts, flat washers and Nyloc nuts and tighten the nuts to safety as shown in the photo at above right.

Fit the outer flap drive arms to each end of the flap shaft and secure each with an AN3 bolt and Nyloc nut as shown at right. Tighten the nuts to safety.



Prepare the flap drive motor assembly

Bolt the mounting bracket to the post on the gear case of the flap motor assembly by placing a Bundy tube through the post and then an AN3-12A through the bracket and the post. Fit a flat washer and a Nyloc nut with the nut facing into the cabin and tighten the nut to safety.

Refer to the photo on the next page for detail.

Fit the flap drive motor assembly

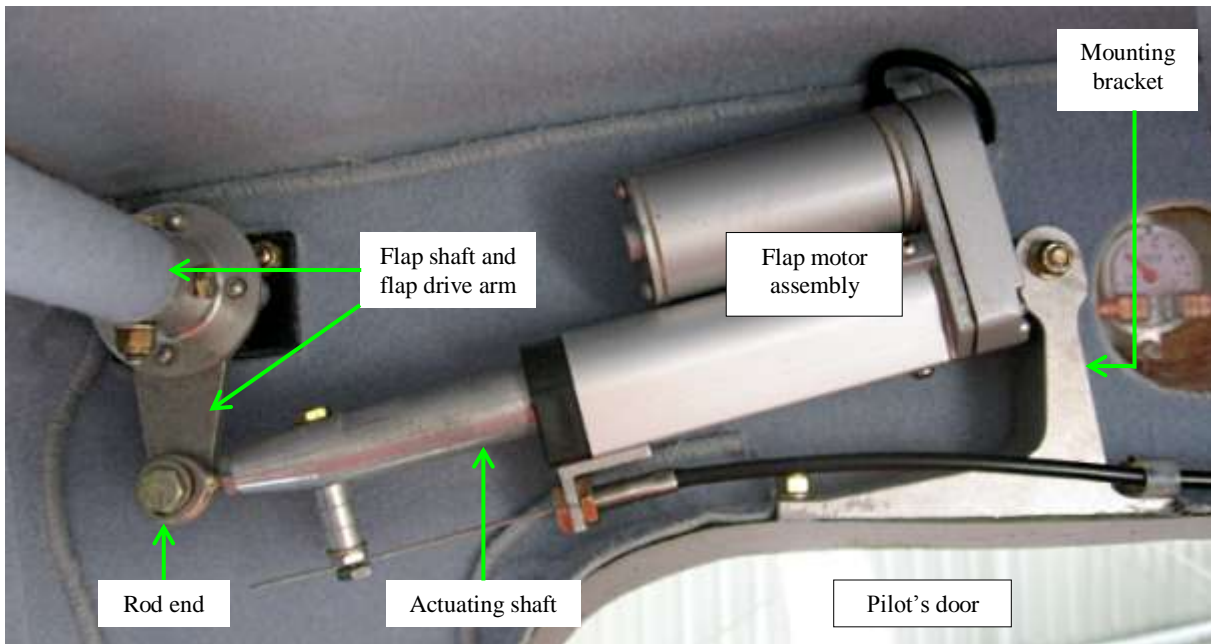

Bolt the rod end of the flap drive motor assembly to the flap drive arm with an AN4-10A bolt through an AN960-516 flat washer, the rod end, an AN960-416 flat washer, the drive arm, an AN960-416 flat washer and a Nyloc nut.

Tighten the nut to safety and then swing the motor assembly forwards and up until the mounting bracket sits on top of the door jamb as shown above. Align the flap drive arm to be completely vertical (i.e. directly under the flap shaft) as pictured above.

Measure forwards from the vertical centre of the flap shaft 272mm and mark the front of the mounting bracket as shown at right. Drill and countersink the 2 x 3/16" mounting holes through the door jamb and mark the location of the mounting bracket.

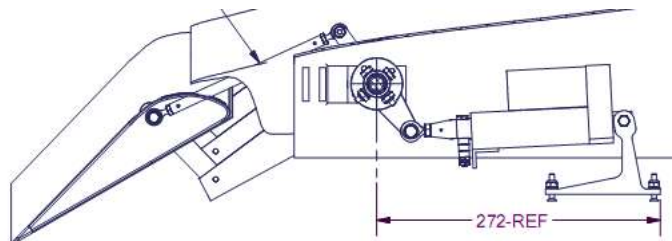

Cut away any upholstery and peel cloth from the where the bracket will be mounted and roughen the bracket and the door jamb surface where the bracket will be bonded into place.

Note that the flap drive motor will sit at a slight angle to the vertical due to the profile of the fuselage skin, so it may be necessary to make the mounting bolt holes slightly oversize to accommodate the mounting angle. It is **very** important that the flap drive motor actuating shaft can be extended and retracted with no binding at any point in its travel. In the factory we fit the flap drive motor in place with packing underneath and power up the motor (12v) and then run the actuating shaft through its full range of travel to check for any binding before flocking the bracket into place.

Flock the mounting bracket into place on an 8mm bed of flock and fix it loosely in place with 2 x 3/16" waxed countersunk screws and Nyloc nuts and leave overnight to cure.

Tighten the nuts to safety the next day.

Fit the flap indicator

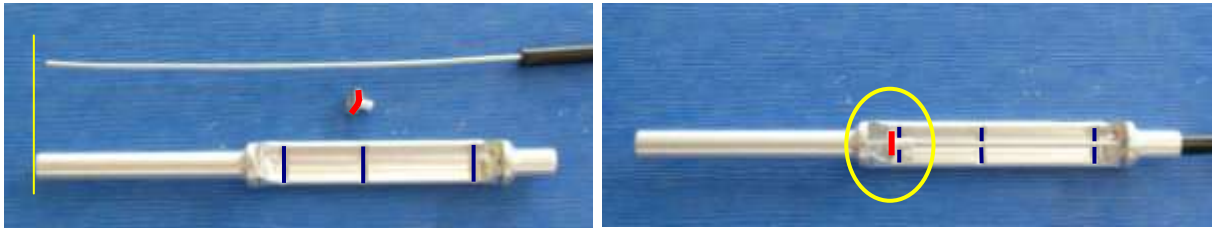

Assemble the flap indicator: paint the outside of the indicator washer red and mark the 3 flap positions in a dark colour. Push the inner cable through the indicator body and through the indicator washer and then all the way into the long end of the indicator body. Slide the washer to the last mark at the long end of the indicator body as circled above right and crimp it to the inner cable. Using the supplied crimping tool, crimp the indicator body to the outer cable.

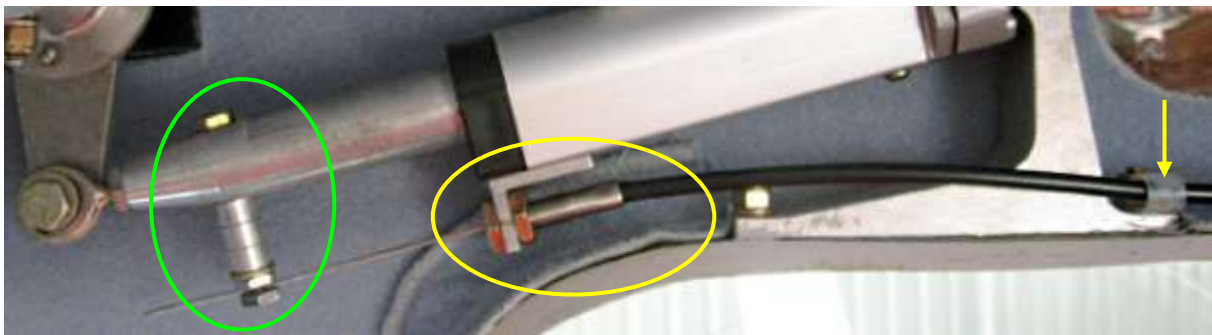

Screw the “L” shaped bracket to the bottom of the motor assembly with a countersunk screw (circled in yellow above), then drop the AN3-16A bolt down through the actuating shaft and add the 3 spacers and the 2 retaining nuts (circled in green above).

Position the flap indicator on the left-hand windscreen pillar so that the cable follows the line of the door opening and remains clear of the opening and screw the flap indicator and cable into place with the supplied nylon clips as shown at right.



Check the outer cable for length and trim as required then crimp the threaded end in place. Fit the threaded cable end to the “L” bracket on the motor with 2 thin nuts and fit the inner cable to the long bolt through the actuating shaft, all as shown in the photo on the bottom of the previous page.

Check that all bolts and nuts are tightened, route the power lead behind the motor assembly and down behind the door opening for later connection in the *Post-Paint>Fuselage>Interior>Install electrical wiring* task. Adjustment of the flap motor and indicator will be done in the *Post-Paint>Wings>Fit flaps* task.

This completes the *Post-Paint>Fuselage>Interior>Fit flap drive motor* task.

Post-Paint>Fuselage>Interior>Fit instrument panel housing

Objectives of this task:

To fit the instrument panel housing to the aircraft. This task will require 2 people.

Materials required:

Card #4: “Panel mount throttle”

Prepare the panel housing

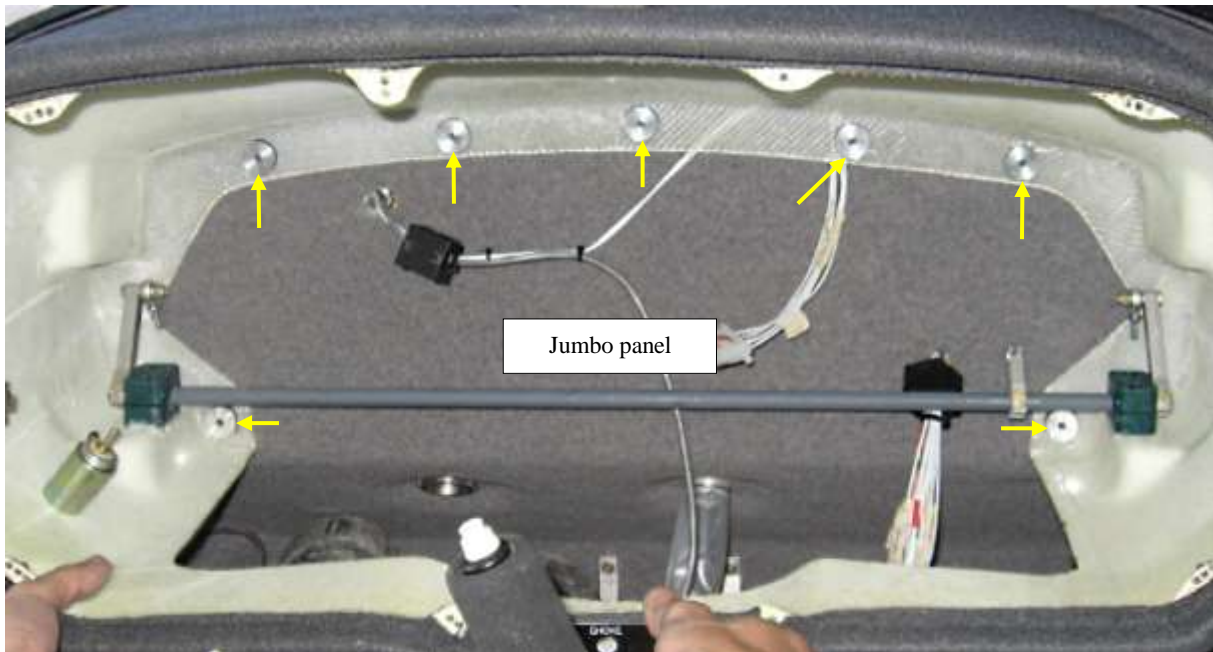
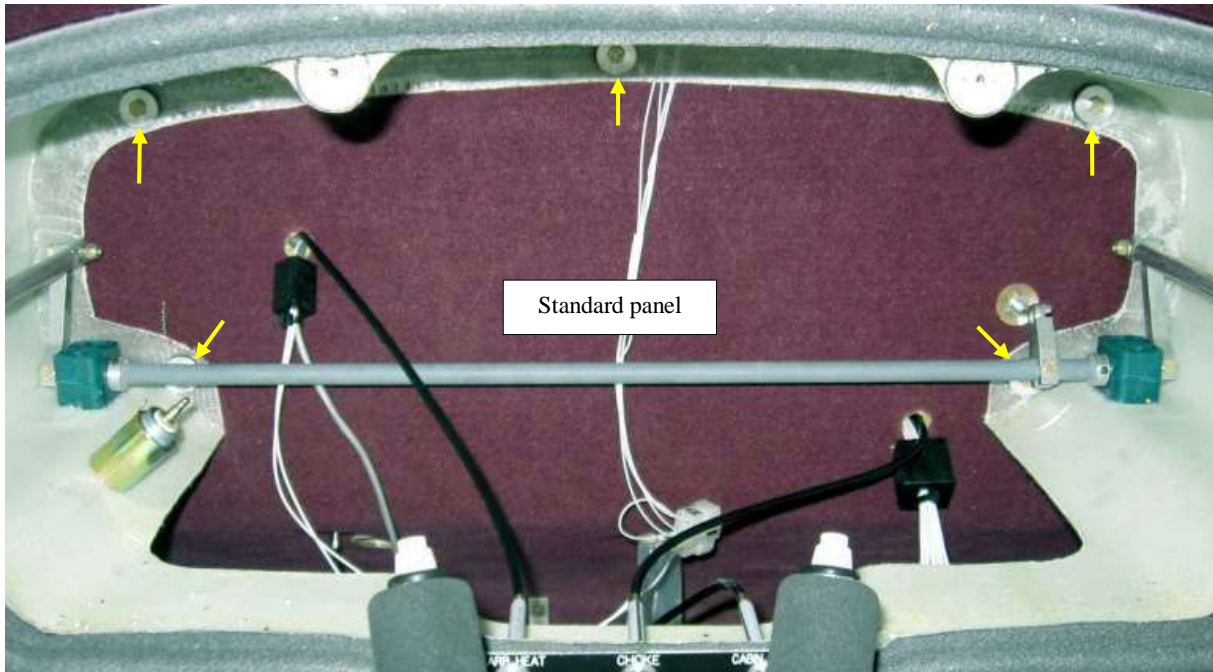

Instrument panel housings come in 2 sizes: *Standard* and *Jumbo*. The *Standard* housing is mounted with 5 mounting bolts while the *Jumbo* housing uses 7 mounting bolts.

Refer to the photos above for mount positioning (arrowed in yellow).

Fit the rubber grommets and the machined aluminium washers to the rear lip of the panel – use a machined washer to mark the centre of each hole then drill each hole to 22mm and fit a grommet into each hole. Drill each machined washer out to 7/32” and fit into each grommet.

Cut away the fabric under the *Carb Heat*, *Choke* and *Cabin Heat* nameplate and flock the nameplate into place with 5-Minute Araldite and flock – hold it in place with spring clamps as shown at right while the flock cures.



Make sure that the nameplate is positioned well down towards, and level with, the bottom of the panel as shown at right.

Drill out the 3 cable holes to suit the cable outer fittings.

This is a good time to fit the wet compass to the top of the panel: much easier now than when the panel has been fitted. Measure the exact centre of the panel and position the compass so that it is square to the front face of the panel and mount with screws and Nyloc nuts.

Tidy under the panel

Once the panel housing is fitted access under the panel will be restricted so take some time now to tidy up under the panel – lock-wire the fuel line sheath to the firewall fitting, check that all the rudder pedal bolts are tightened correctly and generally clean the area out.

Fit the panel

This will take 2 people, one to hold the panel and one to position the panel. Fit a 3/16” drill bit into your drill and have it handy inside the aircraft. The panel is held in place with AN3-12A bolts and steel lock nuts, with the lock nuts located inside the engine compartment.

Hold the panel in place, which is centred in the fuselage and as high up the firewall as it can go. Move any wiring away from the area of the mounting holes and have the second person measure the distance in from the door jambs to the side of the panel and then move the panel until it is exactly in the centre of the aircraft.

When it is correctly located, drill the top centre hole through from the inside (shown at right) and fit a washer and steel lock nut. Check the aircraft for level and then check the panel for level and drill the top left bolt, then the top right and then each of the remaining bolts.



Have the second person watch as each hole is drilled and make sure that the drill bit does not come into contact anything in the engine compartment – wiring, battery, etc.

The drill bit will be visible as a point on the firewall before it breaks through and the person watching must be vigilant to prevent any possible damage. It may only be necessary to move a wire or something before drilling further.

Tighten all of the steel lock nuts to safety.

Locate and fit the throttle cable

The last step is to drill through the firewall for the throttle cable.

The positioning of the hole is important to minimise the chance of the throttle cable binding in the full forward/full throttle position: start by positioning the throttle linkage almost fully forward until the input lever is about 10mm away from the front of the panel housing – the thickness of the tip of your index finger is about 10mm.



With the linkage in that position, make a mark (circled above) **directly** ahead of the output lever (which must face as shown) and then drill a pilot hole at that mark – rotate the throttle linkage backwards to allow access for the drill and hold the drill firmly against the firewall to make sure that it does not move about while drilling.

As before, have the other person check that the drill will not cause any damage as it comes through the firewall and move any wiring out of the way if needed.

Rotate the throttle linkage forwards and check that the pilot hole is precisely in front of the output lever and correct if necessary.

You can now work from the front of the firewall and expand the pilot hole until the throttle cable (complete with the adjustment nuts) can just pass through the hole.

Drill out 2 flat penny washers to fit over the outer cable and then cut a slot in each so that they can be fitted over the throttle cable. One will fit to the cable on each side of the firewall.

You will need to carefully grind both ends of the throttle cable to size – the manufacturing process often leaves some excess solder on both fittings and sometimes the ball end may have the inner cable standing slightly proud, which will need to be ground back a little.

Fit the throttle cable into place through the firewall. Connection and adjustment of all cabling will be addressed in the task *Post-Paint>Firewall forward>Engine control cabling*.

Fit the throttle input shafts through the pivot blocks and fully onto the rod ends on the input levers and Loctite each input shaft into place with a drop of Loctite 620. The pilot's side input shaft will require a machined collar to be fitted on the shaft on each side of the pivot block.

This completes the *Post-Paint>Fuselage>Interior>Fit instrument panel housing* task.

Post-Paint > Fuselage > Interior > Engine control cabling

Objectives of this task:

To fit all engine control cabling from the instrument panel to the engine.

Materials required:

Cables: Throttle, Carb Heat, Choke, Cabin Heat (optional – see Card #25)

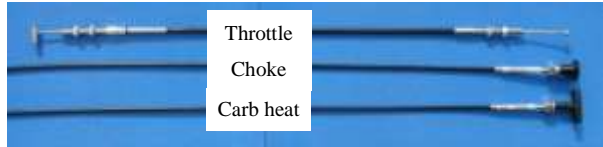

Size the outer cables

The Carb Heat, Choke and the optional Cabin Heat outer cables will need to be cut to length. This is done by removing the inner cables completely and then fitting the outer cables through the panel and routing them through the firewall to the appropriate locations and then trimming each outer cable to length. The Choke and the optional Cabin Heat cables will then need to have allowance made for the threaded end section, which is then crimped onto the cut end (use the crimping tool, shown at right). The throttle cable is supplied ready to use.



Fit the cables to the instrument panel

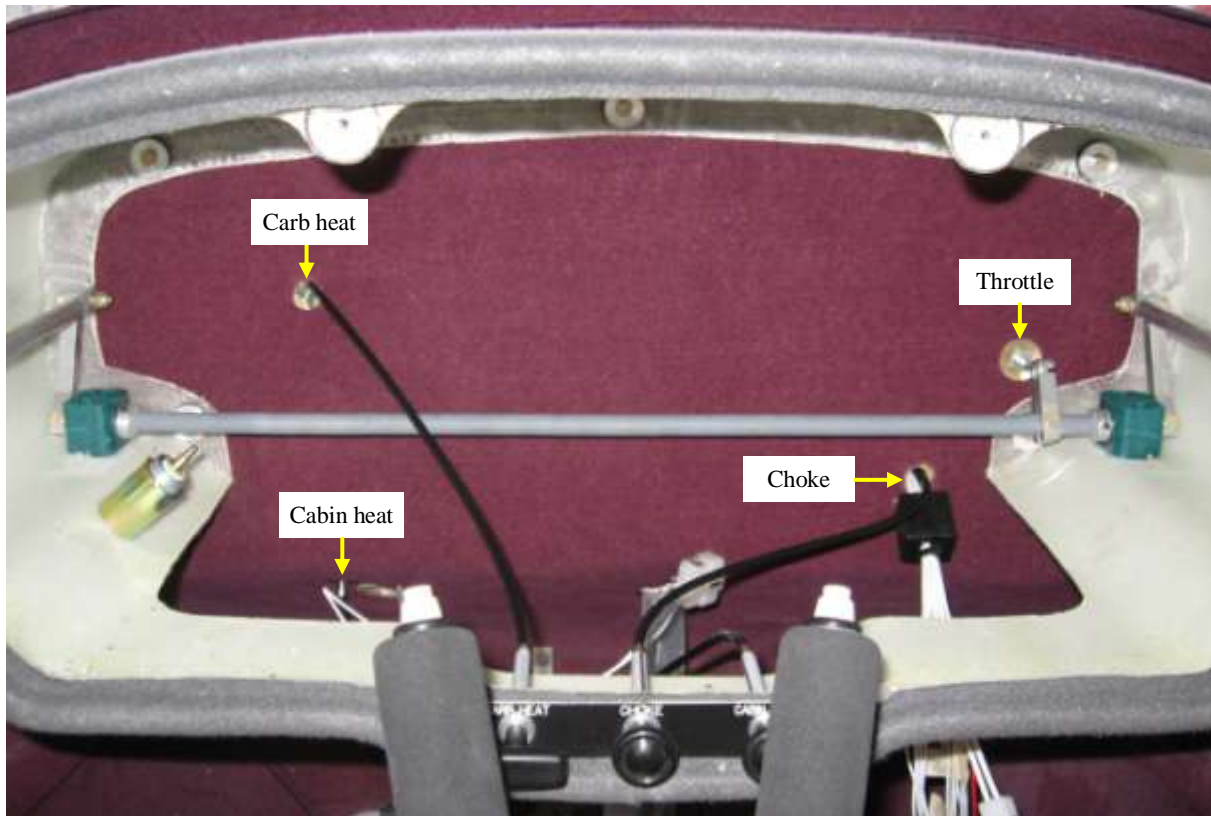

Fit the Carb Heat, Choke and the optional Cabin Heat cables to the lower centre of the instrument panel through the nameplate and secure each to the panel with a serrated washer and lock nut and then route the cables through the firewall as shown above.

Fit the throttle cable through the firewall from the engine side with the ball end inside the cabin and secure with a slotted flat washer and nut on each side of the firewall as shown.

Fit the ball end of the throttle cable into the drive arm on the throttle shaft.

Throttle and choke

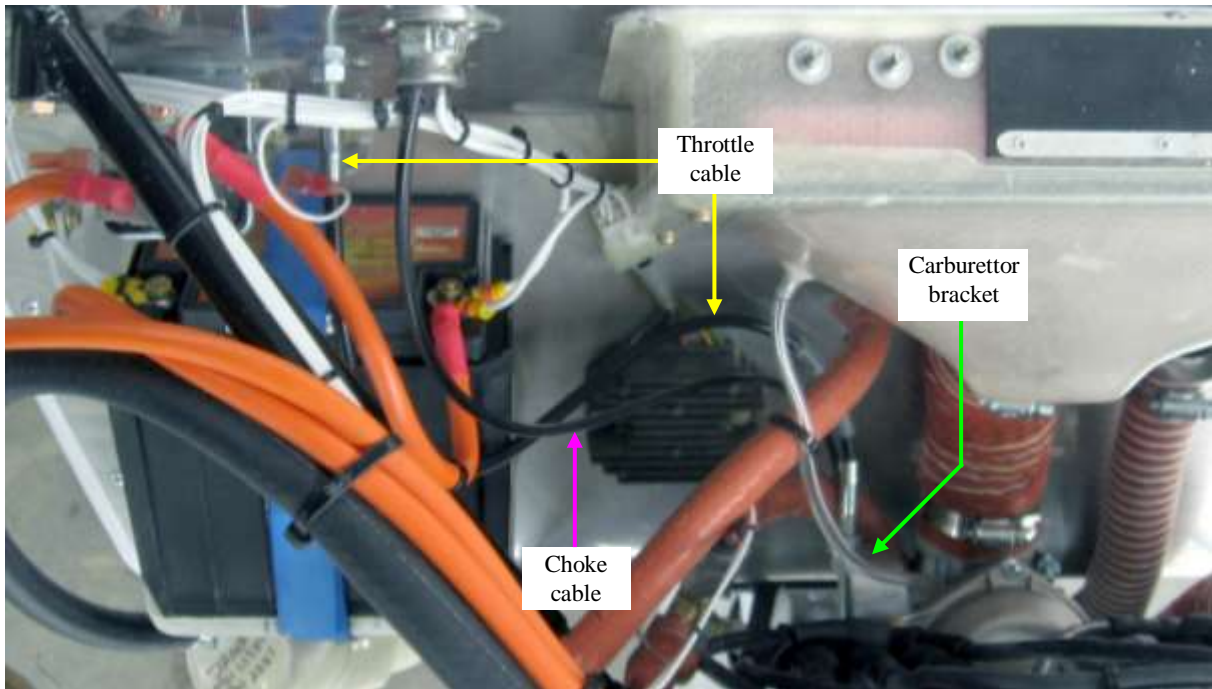

Note the cable routing shown above – this photo was taken looking straight down.

Fit the throttle cable first: undo the front nut completely until it is resting on the inner cable and then fit the inner cable through the slotted top hole in the bracket and fit the threaded cable end into the bracket. Fit the lock nut onto the threaded cable end and tighten so that the lock nuts are in the centre of the threaded cable end.

Fit the barrel end of the cable into the throttle linkage on the carburettor with a washer each side and a split pin through the hole in the barrel end of the cable.

Adjust the throttle cable until at full throttle (with the panel mounted throttle shafts fully forward) the throttle linkage is just touching the front stop on the carburettor. Tighten all 4 lock nuts firmly for the moment – fine adjustments will be made later.

Put 1 lock nut on the threaded end of the choke cable and fit it through the bottom hole in the bracket. Fit the other lock nut, centering the threaded end in the bracket.

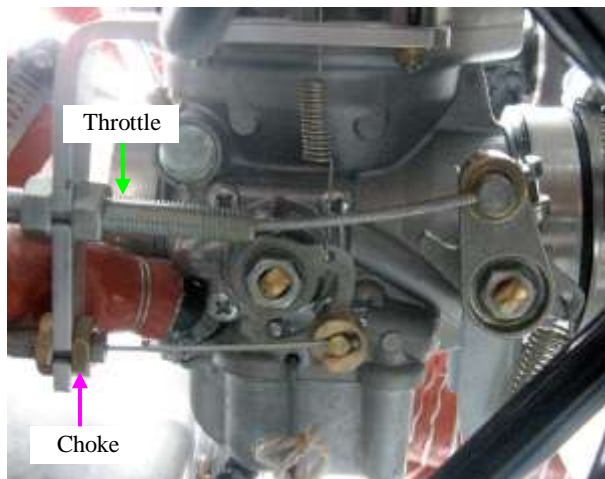

Right hand side view of carburettor body showing cables

Make sure that the choke drive arm is fully forward and slip the brass ferrule over the inner cable then fit the ferrule into the hole in the drive arm. Bend the inner cable at right angles in front of the ferrule. Cut the excess inner cable off. Slip the ferrule through the retaining collar and fit to the drive arm with a washer and split pin fitted to the brass ferrule on the underside of the drive arm. Refer the photos and drawing on the next page for detail.

Adjust the choke cable until with the choke all the way in the choke arm just touches the stop on the carburettor body. Tighten the lock nuts firmly.

Carb heat

Run the outer cable through the clamp and secure by tightening the clamp, then slip the brass ferrule over the inner cable.

Make sure that the air valve drive arm is fully forward and then fit the ferrule into the hole in the drive arm. Bend the inner cable at right angles in front of the ferrule. Cut the excess inner cable off. Slip the ferrule through the retaining collar and fit to the to the drive arm with a washer and split pin fitted to the brass ferrule on the underside of the drive arm.

Adjust the Carb Heat cable with the clamp until with the Carb Heat “T” handle all the way in the air valve drive arm is fully forward as shown above. Tighten the clamp bolts firmly.



Cabin heat

Put 1 lock nut on the threaded end of the Cabin Heat cable and fit it up through the hole in the firewall beside the Cabin Heat valve. Fit the other lock nut, fixing the threaded cable end through the firewall.

Make sure that the Cabin Heat valve drive arm is fully forward and then fit the ferrule into the hole in the drive arm. Bend the inner cable at right angles in front of the ferrule. Cut the excess inner cable off. Slip the ferrule through the retaining collar and fit to the to the drive arm with a washer and split pin fitted to the brass ferrule on the underside of the drive arm.

Adjust the Cabin Heat cable until with the Cabin Heat knob all the way in the Cabin Heat valve is fully closed. Tighten the lock nuts firmly.

Parts List			
ITEM	PART NUMBER	DESCRIPTION	QTY
1	4A454B0D-1	CHOKE / CARBY HEAT CABLE END COLLAR	1
2	4028894-7	LEVER	1
3		WIRE STUB	1
4	4A454C0D-1	CHOKE / CARBY HEAT CABLE END LUG	1
5	AN960-10	3/16" FLAT WASHER	1
6	MS24665-132	COTTER PIN	1

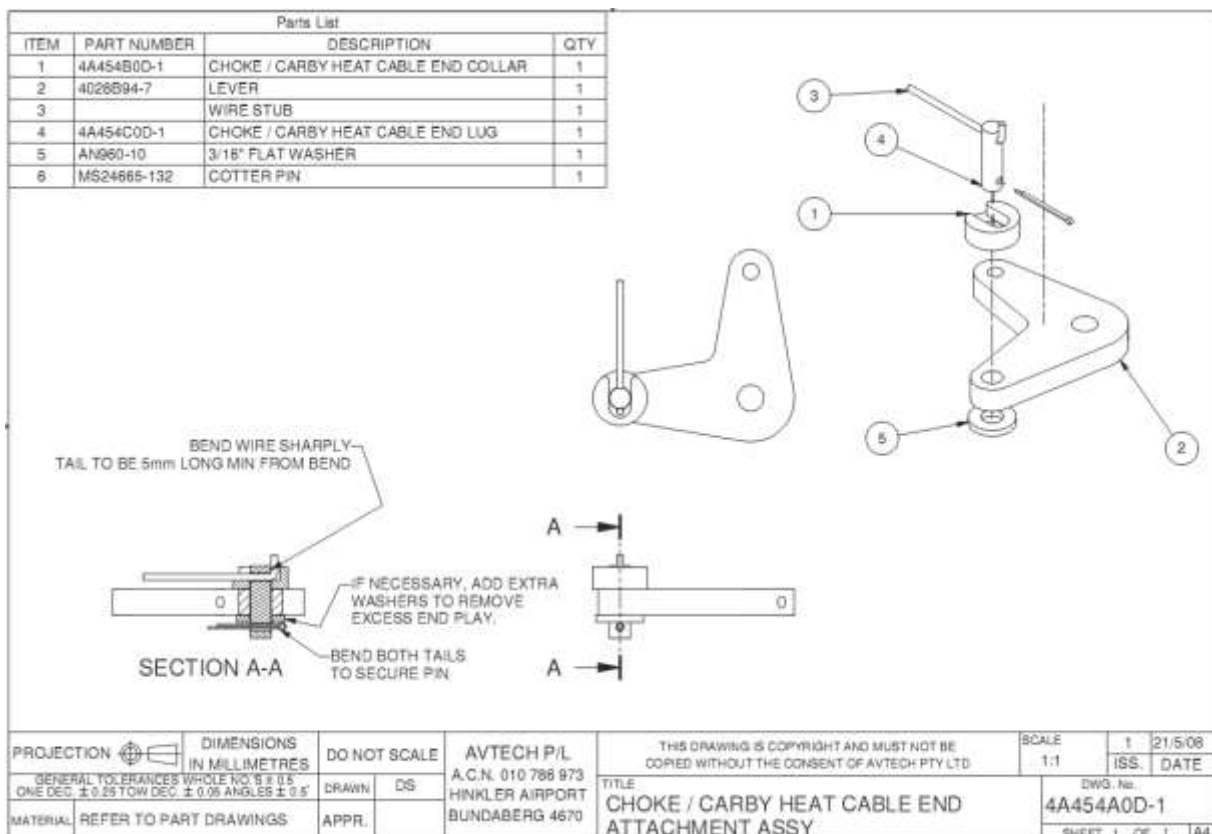

PROJECTION	DIMENSIONS IN MILLIMETRES	DO NOT SCALE	AVTECH P/L A.C.N. 010 786 973 HINKLER AIRPORT BUNDABERG 4670	THIS DRAWING IS COPYRIGHT AND MUST NOT BE COPIED WITHOUT THE CONSENT OF AVTECH PTY LTD	SCALE 1:1	1 ISS. DATE
GENERAL TOLERANCES: WHOLE NO'S ± 0.5 ONE DEC. ± 0.25 TO TWO DEC. ± 0.05 ANGLES ± 0.5°			DRAWN DS	TITLE CHOKE / CARBY HEAT CABLE END ATTACHMENT ASSY	DWG. No. 4A454A0D-1	
MATERIAL REFER TO PART DRAWINGS			APPR.	SHEET 1 OF 1 A4		

This completes the *Post-Paint > Fuselage > Interior > Engine control cabling* task.

Post-Paint>Fuselage>Interior>Fit the instrument panel

Objectives of this task:

To pre- and final fit the instrument panel to the panel housing. This task will require 2 people so have a friend come over and help you for an hour or so.

Pre-fit the panel

Remove the throttle knobs from the throttle input shafts.

Both people should sit in the aircraft with the panel held between them. The person in the right-hand seat should reach over the top of the panel and push all of the multi-pin connectors, instrument tubing, radio and GPS wiring from the panel back inside the panel housing.

Working together, offer the panel up to the housing. Lift the bottom of the panel over the carburettor heat and choke knobs, then carefully ease the top into place. You may need to grind small amounts out of the housing to clear items such as the mag switches, so use a pen to mark what needs trimming and remove the panel. Trim away the marked areas, vacuum away any debris from the grinding process and refit the panel until it slips neatly into place.



Fit the panel

Refit the panel as before, but this time the person in the right-hand seat should reach over the top and connect the panel. Each multi-pin connector should have been clearly marked (“A”, “B”, “C”, “D” or “E”): join each connector pair by pushing them together firmly until the safety clip clicks into place. Connect the VHF antenna cable and transponder cable.

Fit the panel into the housing and secure it in place with machine screws.

Now you will need to work from under the panel: connect the static line and pitot line with brass tube joiners and plug in the radio wiring plug.

If you are using a panel mounted GPS, lower the antenna to the floor and then route the antenna and cable out the bottom right of the panel and back up until the antenna can be velcroed to the top right of the panel housing near the right corner of the windscreen. The antenna wire can be tucked back into the small gap between the housing and the firewall and the excess cable length can be coiled up and zip tied up inside the housing.

Refit the throttle knobs and tighten them firmly.

At this point there will be a large amount of wiring and tubing emerging from the access hole in the lower front of the console and going up into the panel. In the upholstery kit there is a piece of upholstery fabric with a Velcro strip at each end: hold the wiring bundle together and wrap this fabric around it and let the Velcro strip hold it in place: this will tidy things up.

Ideally no loose wiring should hang down under the panel housing, so tuck up any wires that need tidying and zip tie them into place.

This completes the *Post-Paint>Fuselage>Interior>Fit the instrument panel* task.

Post-Paint>Fuselage>Interior>Fit upholstery 2

Objectives of this task:

Fit the remaining interior trim to the aircraft, completing the interior fit out.

Materials required:

Jabiru upholstery kit or equivalent

High heat contact adhesive

Card J9 “Seatbelts”

Flap drive shaft and flap drive motor cover

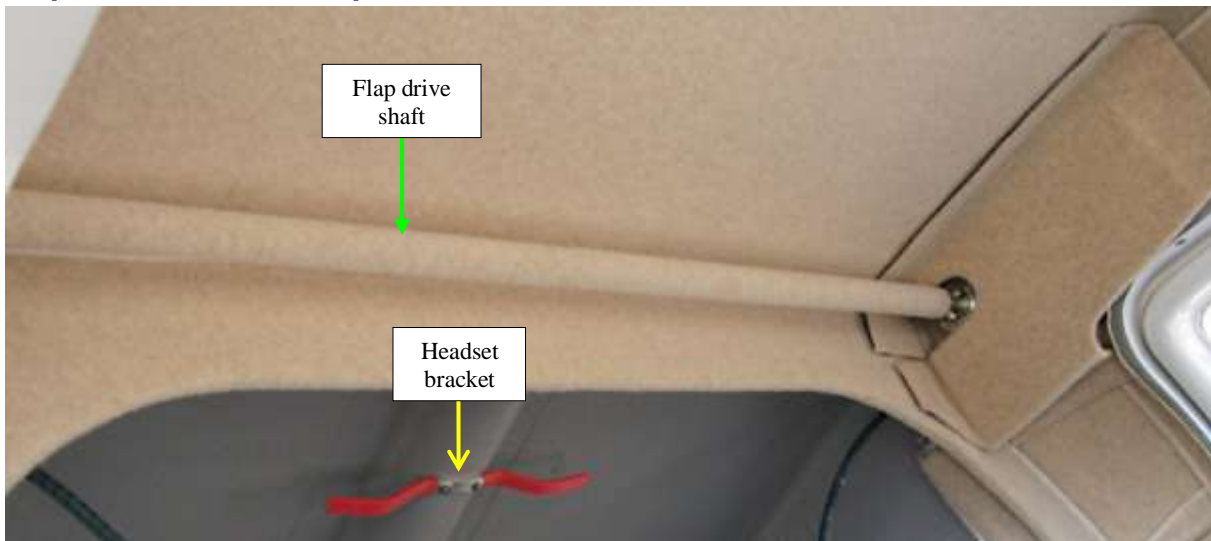

Wrap the flap drive shaft in upholstery fabric and fix into place with contact adhesive. The join line should be at the top rear of the shaft.

Use Velcro tabs to hold the drive motor cover into place.

Headset bracket

Position the headset bracket on the top longitudinal rib and fix in place with 2 TLR rivets as shown arrowed in yellow in the photo above.

Floor coverings

Test fit the floor coverings first – you will need to carefully cut the front covering to fit around and under the rudder pedal mounts.

The floor coverings should overlap the sidewall and console fabric slightly so that no fibreglass can be seen.

Fix the floor coverings into place with contact adhesive.





Fuel line covering

Wrap both sheathed fuel lines with the supplied lengths of Velcro-edged fabric – position the Velcro join line so that it faces towards the outside of the aircraft. Use zip ties to secure the sheathed fuel lines to the rear of the fuselage rib as shown at right.

Rear bulkhead sound curtain

Glue 8 evenly spaced Velcro strips around the rear bulkhead and attach the sound curtain by pressing it onto them.

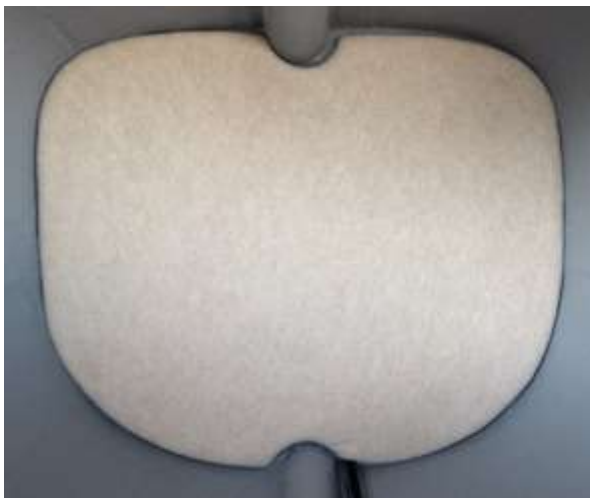

Seat covers

Identify the left and right side seat covers. Slip each seat cover over the correct seat back and pull the cover as far down as you can, then roll the lower part of the cover over the seat base and press the Velcro strip along the front edge into place.



Seatbelts



Bolt the seatbelts to the seatbelt fittings – the shoulder harness fits to the outside of each seat while the lap part of the harness fits beside the console.

Each seatbelt fitting is fitted to the outside of the mounting bracket (away from the seat) with an AN3 bolt with one washer under the head, through the mounting bracket, the seatbelt fitting, then the heavy flat washer (from the “Seatbelts” card) and a plain washer then the Nyloc nut, all as shown in the photo above. Tighten the Nyloc nuts to safety.

Aileron bellcrank cover

Note that this cover is fitted *after* the wings have been fitted and the aileron cables have been connected and adjusted. It is included in this *Upholstery 2* task for convenience.

Slip the cover over the rear of the console as shown in the photo above: check that the aileron cables slots are correctly positioned and they do not cause any restriction to the aileron cables and fit the cover in place with 3 x 6G stainless self tapping screws: 1 each side at the front of the cover and 1 at the rear of the cover.

This completes the *Post-Paint>Fuselage>Interior>Fit upholstery 2* task.

Post-Paint>Fuselage>Fit rudder, elevator and elevator trim

Objectives of this task:

To fit the rudder, and elevator and elevator trim assembly to the empennage.

Fit the rudder

Hold the rudder up to the vertical fin and fit it into place with the hinge pins: the top pin will be fitted up through the hinge from the bottom while the 2 lower pins will be fitted down from the top. Check for free movement of the rudder from stop to stop.

Locate the ends of the hinge pins in the retaining slots and secure each pin in place with pin retainers – the locations are arrowed at right.

Each pin retainer will be held in place with a 5/32" machine thread screw.

Mark each retainer screw with *TorqueSeal*.

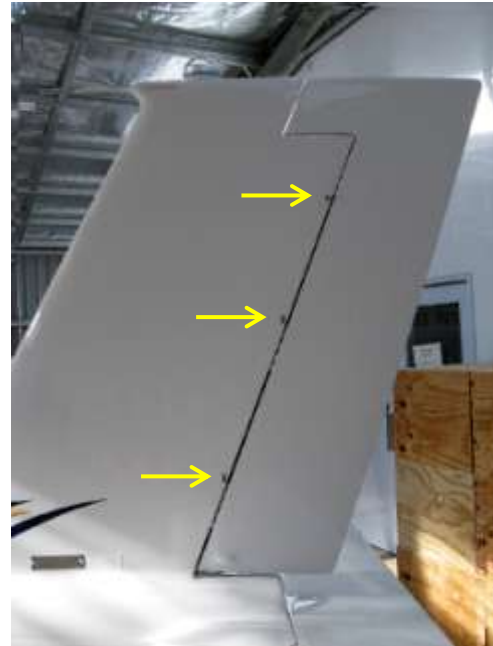

Connect the rudder cable

Withdraw the rudder cable from the slot at the base of the vertical fin and pull it out until the locating groove in the outer cable is level with the 2 mounting bolt holes in the side of the fin.

Clamp the outer cable to the fin with 2 x AN3-6A bolts fed from inside the fin, then the angled aluminium plate with the narrow side facing the front of the aircraft, the clamp backing plate, the saddle clamp (taking care to locate the locating key on the saddle clamp in the locating groove in the outer cable), then flat washers and Nyloc nuts, all as shown in the photo below.



Fit the rod end to the rudder drive arm with an AN3-8A bolt fitted from the top and down through the drive arm, then an AN960-416 (3/16") flat washer, then the rod end followed by an AN960-515 (1/4") flat washer and a Nyloc nut as shown above.

Tighten each Nyloc nut to safety and mark the end of each nut with *TorqueSeal*.

Adjust the rudder travel



Make a template that will sit over the rear of the empennage and tape it in place. Find the centreline of the fuselage and mark a 5mm offset to the **right** of the centreline onto the template, then mark **78mm** each side of that offset mark as shown in the photos above.

Place a saw stool under the front of the fuselage to lift the nose wheel off the ground and then adjust the rudder cable length so that the rudder sits on the 5mm right mark with the rudder pedals centred, with the pedals all level.

Lock both rod end lock nuts firmly and mark each one with *TorqueSeal*.

Now use the rudder pedal adjustment set screws (shown arrowed at right) to adjust the rudder travel so that the rudder deflects *exactly* 98mm to each side of the offset centre mark as shown in the photos above.

When this has been done tighten up both of the lock nuts firmly and mark each one with *TorqueSeal*.

The rudder is now adjusted.

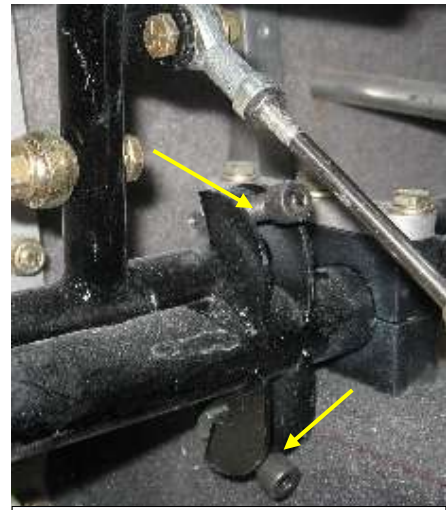

Rudder pedal adjustment detail

Fit the elevator

Hold the elevator up to the horizontal stabiliser and fit the hinge pins in place: all pins are fitted by pushing them in from the outside of the hinge and towards the rudder.

Check for free movement of the elevator from stop to stop.

Locate the ends of the hinge pins in the retaining slots, push the trim lever on the console fully forward and then apply a length of *Wotan* cloth tape to the top of the gap between the elevator and the horizontal stabiliser as shown at right, pressing the tape over the top of the hinge pins so that they break through the tape surface. Use one length of tape on each side of the tailplane, make sure that there are no wrinkles and press the tape firmly down.

Secure each hinge pin in place with pin retainers.

Each pin retainer will be held in place with a 5/32" machine thread screw.

Mark each retainer screw with *TorqueSeal*.



Connect the elevator cable

Fit the drive arm extension to the elevator drive arm: secure with an M4 x 25 bolt, washer and Nyloc nut through the top hole. Tighten firmly and trim off any excess bolt length.

Fit the elevator cable rod end to the elevator drive arm with an AN3-10A bolt fitted through the lower hole in the elevator drive arm and the centre hole in the drive arm extension. Fit an AN960-416 (3/16") flat washer, then the rod end followed by an AN960-515 (1/4") flat washer and a Nyloc nut.

Do not tighten the Nyloc nut or the rod end lock nut until the cable length has been adjusted in the next step.

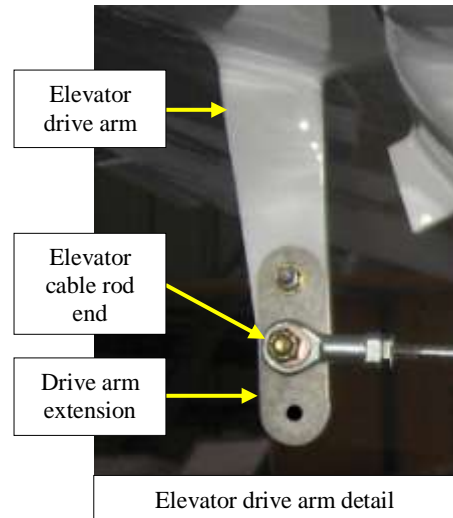

Adjust the elevator travel

Use the supplied deflection templates to check the up and down travel of the elevator.



Hold the control stick all the way forward (have someone help you) and check the amount of down deflection and adjust the cable length (by screwing the rod ends in or out an equal amount at each end of the cable) until the down deflection is correct.



Now have your helper hold full back stick and check the amount of up deflection: it should be very close to correct if the down deflection is OK, however you may need to make some fine adjustments to equalise elevator travel until both up and down deflections are correct.

The elevator must clear the rudder and the down stop by 2mm at full deflection.

Recheck the up and down deflections and then lock the rod end lock nuts at each end of the cable and mark each rod end lock nut with *TorqueSeal*. The elevator is now adjusted.

Assemble and fit the elevator trim assembly

Refer to the drawing on the next page: Assemble the trim pivot: press the 2 sealed bearings into the hub and then pop rivet the assembly together. Assemble the trim spring unit, adjust the rod end to almost full thread depth and tighten the lock nut.

Connect the trim spring unit to the trim pivot with an AN3-13A bolt through the black pivot block in the middle of the spring assembly and the top hole in the trim pivot arm, taking careful note of the arrangement of the washers and the sleeve between the two items.

Connect the trim cable rod end to the trim pivot with an AN3-12A bolt through lower hole in the trim pivot arm. Fit the trim pivot to the trim horn with an AN4-14A bolt.

Fit the rod end of the trim spring unit to the bottom hole in the elevator drive arm extension with an AN3-07A bolt.

Push the trim lever on the console fully forward, hold the trim pivot arm fully forward as shown at right, align the trim cable as shown, then drill the 2 x 3/16" trim cable clamp holes through the trim horn.



If you are working alone you can wedge the trim pivot into position for this step.

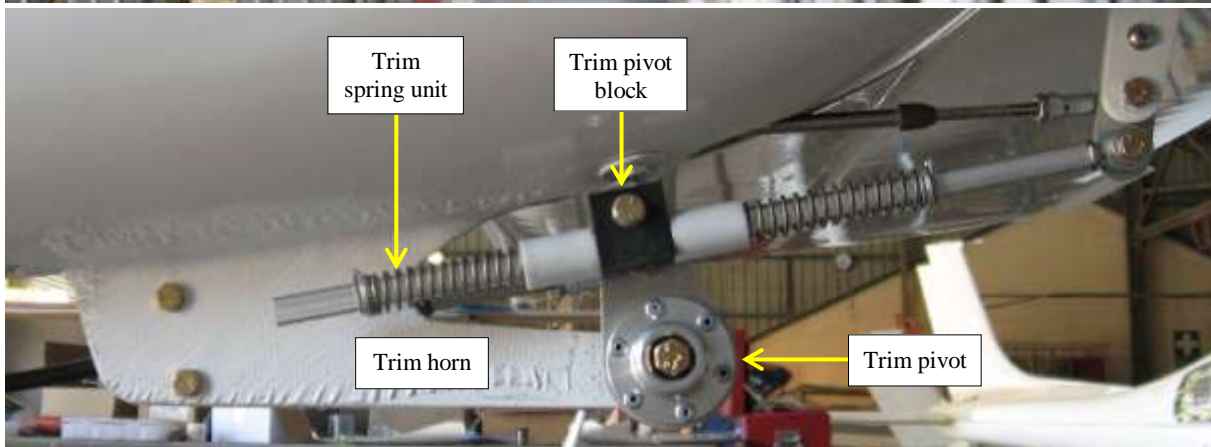
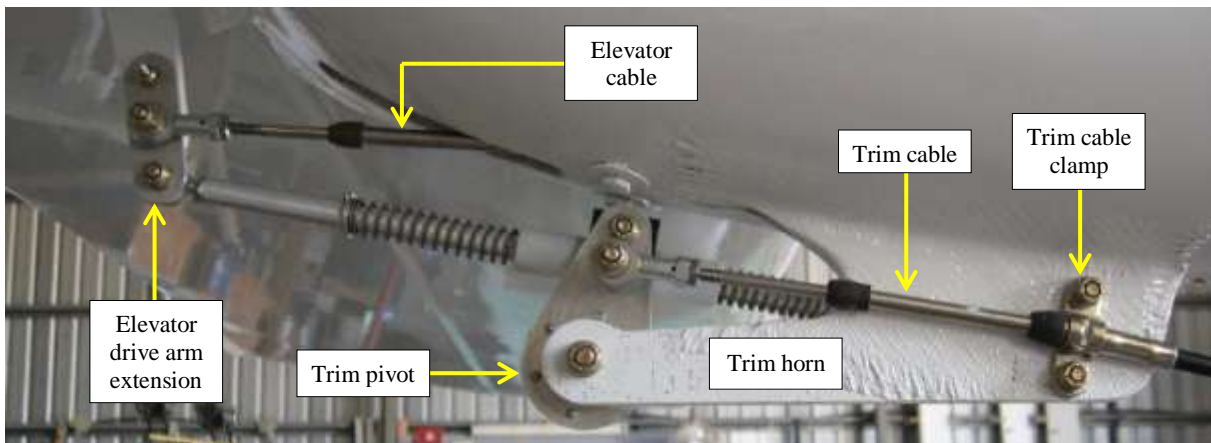

Attach the outer trim cable to the right hand side of the trim horn with 2 x AN3-06A bolts fitted through trim horn, the clamp backing plate and then the saddle clamp and securing with flat washers and Nyloc nuts, taking care to locate the locating key on the saddle clamp in the locating groove in the outer cable before tightening the Nyloc nuts to safety.

Use the supplied deflection templates to re-check the up and down travel of the elevator.

NOTES:

1. BOLT LENGTHS GIVEN ARE NOMINAL. USE SHORTER BOLTS IF REQUIRED. ENSURE M1 OF 2.5 THREADS SHOW THRU NUT.
2. CPNo. = COMMERCIAL (NON JABIRU) PART NUMBERS
3. QUANTITIES GIVEN ARE FOR THE COMPLETE TRIM CONTROL ASSEMBLY AS SHOWN IN SHEETS 1-3 OF THIS DRAWING.

DM	2	30/7/04
SCALE	1	21/8/02
VAR	ISS	DATE
DRAWN BY: 3250023-2		
SHEET 1 OF 3		

Parts List

ITEM	PART NUMBER	DESCRIPTION	QTY
1	2056/023	ELEVATOR ASSY	1
2	3065094	MOUNTING PLATE TRIM ASSEMBLY	1
3	AN990-416	1/4" FLAT WASHER	9
4	AN3-10A	3/16" BOLT	2
5	AN990-10	3/16" FLAT WASHER	10
6	MS20365-1032	3/16" NYLOC NUT	8
7	3102284	SPACER - DRIVE PLATE	1
8	AN4-14A	BOLT	1
9	MS20365-428	1/4" NYLOC NUT	1
10	PB0078N	BEARING DEEP GROOVE 1EE2-2RS	2
11	3103284	BEARING RETAINER - TRIM CONTROL	1
12	3103184	BEARING PIVOT MOUNT BLOCK	1
13	PH0199N	1/8" AL POP RIVET (CPNo. 73A54-6)	6
14	3043284	SPACER ROD END	1
15	PB00194	3/16" FEMALE ROD END	3
16	AN3-12A	3/16" BOLT	1
17	AN3-13A	3/16" BOLT	1
18	3061094	PIVOT BLOCK	1
19	3043194	SLEEVE PIVOT BLOCK	1
20	3131014	SPRING RETAINER ROD	1
21	3130014	SPRING CAP RETAINER TRIM CONTROL	2
22	AN990-616	3/8" FLAT WASHER	2
23	MS24665-132	COTTER PIN	2
24	PB0009N	3/16" MALE ROD END	1
25	3063094	EXT. TRIM HORN	1
26	AN3-07A	3/16" BOLT	1
27	AN316-3	3/16" NUT	5
28	PC01484	TRIM CABLE ASSEMBLY	3
29	PC0089N	CABLE CLAMP SHIM	3
30	PC0089N	CABLE CLAMP	3
31	PH0359N	METAL THREAD M4x25 BOLT	1
32	PH0469N	5/32" FLAT BRASS WASHER	1
33	PH0209N	M4 NYLOC NUT	1
34	AN3-06A	3/16" BOLT	2
35	AN990-416L	1/4" FLAT WASHER	1
36	PX00694	TRIM SPRING (SOFT)	1
37	PX7A003N	TRIM SPRING (HARD)	1

USE AN990-416L
1/2 THICKNESS WASHER

ELEVATOR CABLE -REF

PROJECTION	IN MILLIMETRES	DO NOT SCALE	AVTECH P/L
LIMITS UNLESS SPECIFIED OTHERWISE ± 0.1	UNLESS OTHERWISE SPECIFIED	DRAWN	AC.N. 010 788 873
MATERIAL	APPR.	DS	HNKLER AIRPORT
			BUNDBERG 4670

TITLE: TRIM CONTROL ASSEMBLY (J200/J400)

THIS DRAWING IS COPYRIGHT AND MUST NOT BE COPIED WITHOUT THE CONSENT OF AVTECH PVT. LTD.

This completes the *Post-Paint>Fuselage>Fit rudder, elevator and elevator trim* task.

Post-Paint>Fuselage>Fit doors

Objectives of this task:

At this stage the doors have been painted and now they can be refitted to the aircraft.

Materials required:

Door hardware from Card # J1 'Doors'

Fit the door seals

Clean the inside of the door lip and fit the white door seal rubber around the entire outer edge of the door. The door seal is adhesive backed: peel the backing paper back as you stick the seal into place. Start and finish at the top hinge.

Refit the doors

Fit the hinges to the door pivot arms using the screws and nuts that were used in the *Pre-Paint>Fuselage>Pre-fit doors* task and tighten the nuts to safety.



Fit each door to the fuselage. Apply a single drop of Loctite 242 to each screw, then fit the top screw first to hold the top of the door, then fit the bottom screw and check that the door closes in the centre of the door opening – there will be enough movement in the hinge screw holes to allow the door to be centred very accurately.

Tighten both screws firmly while the door is shut and both latches are closed.

Check that the door can be opened and closed easily and make any minor adjustments that may be required.

Remove the masking

Both sides of the window will still be masked at this stage – carefully remove all of the masking until you only have the blue “*Fine Line*” masking tape left around the window and then very carefully peel the “*Fine Line*” tape from the window by pulling the tape back over itself and in towards the centre of the window as shown in the photo at right.

This will allow the edge of the tape to cut the paint to a nice clean edge, which is the reason for using the tape.

Never pull any masking tape towards the painted surface, always pull **away** from the painted surface.

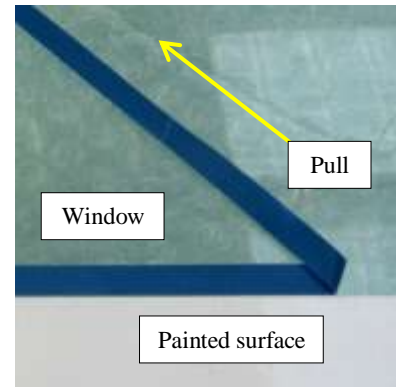

Fit the door swing straps

These straps prevent the doors from swinging too far forward in windy conditions.

Loop a length of black webbing through the bracket at the front of each door and measure out enough webbing so that the door can be opened to no more than 90° to the fuselage and the webbing can be wrapped around the inside the front of the door jamb.

Cut the webbing to length and secure to the back of the door jamb with a countersunk screw.



Use your soldering iron to burn the bolt hole through the fabric – this will seal the edges of the hole.

Seal the cut ends of the webbing with a flame.

Fit the screw through the door frame: countersink the hole and fit the screw with a Tinnerman washer under the head then place a penny washer over the webbing as shown at right and secure with a Nyloc nut tightened firmly.



Fit the striker plate

Place the striker plate on the door jamb and align the latch pin hole. Hold the striker plate in place with some tape and check that the door can be closed and that the latch pin will fit through the striker plate – make any required adjustments and then rivet the plate in place with 2 x 5/32” rivets as shown in the photo at right.

Repeat for the other door.



Fit the door locks

Fit the door locks through the lock holes in the fuselage behind each door and fix in place with the retaining nuts. Tighten each retaining nut firmly.

Fit the locking arm to the end of the shaft with the supplied screw: apply a drop of Loctite 242 to each screw.

Check that the locking arm works in the correct sense and that the key can be removed at both the locked and unlocked positions. It may be necessary to lengthen the slot slightly if the key cannot be removed in the locked position.



Clean the windows

Now you can clean the windows: start with a small amount of methylated spirits on a clean cloth and carefully remove any dust and debris from the painting process then, using a clean soft cotton cloth, polish both sides of each window with a good quality cleaner such as *Novus Plastic Polish*: start with *Novus #2* and then finish with *Novus #1*. *Novus #3* should only be used for buffing out extremely heavy scratches.

Support an open door with one hand while you polish the window.

Any cleaner/polish used must be safe to use on acrylic and must not contain any silicon.



This completes the *Post-Paint>Fuselage>Fit doors* task.

Post-Paint>Fuselage>Firewall forward>Final assembly

Objectives of this task:

To complete all of the remaining firewall forward assembly work.

Materials required:

Card #15 ‘Spares’

Card #22 ‘Hot air mixer box’

Card #23 ‘Oil bottle’

Card #25 ‘Cabin heater’

Prepare the muffler

Fit the inlet air heat shroud to the muffler with 2 large hose clamps: align the shroud as pictured with the cutaway in the shroud just touching the exhaust pipe.

Tighten the hose clamps firmly.

Fit the cabin heater heat exchanger to the exhaust pipe and push up until it touches the muffler and tighten the Allen head cap screws.

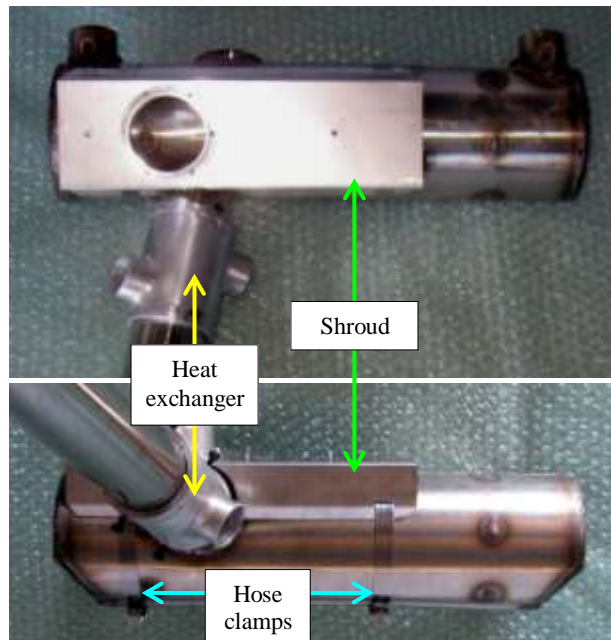

Fit the muffler

Remove the red sealing caps from the ends of the exhaust pipes and fit the pipes into the inlet holes in the front of the muffler.

Hold the muffler in place by fitting the supplied springs from the tags on the muffler to the tags on the exhaust pipes as shown arrowed in the photo at right.

Check if the muffler is touching on the set screws (arrowed in purple at right) that hold the cover directly above the muffler: if the muffler *is* touching these screws it could eventually wear a hole in the muffler, so mark any spots where the set screws are touching, remove the muffler and use a hammer to tap a small indent into the top of the muffler. Refit the muffler and recheck.

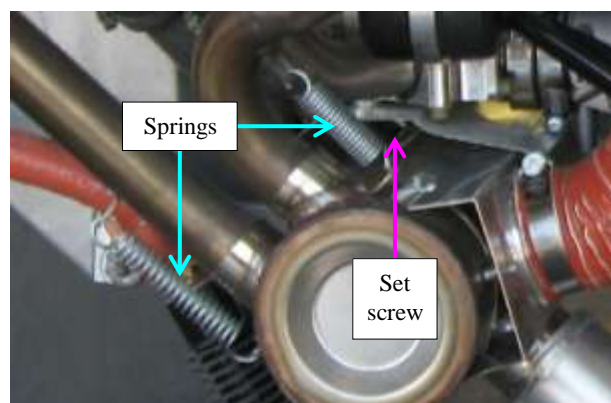

Connect the inlet air scat hoses

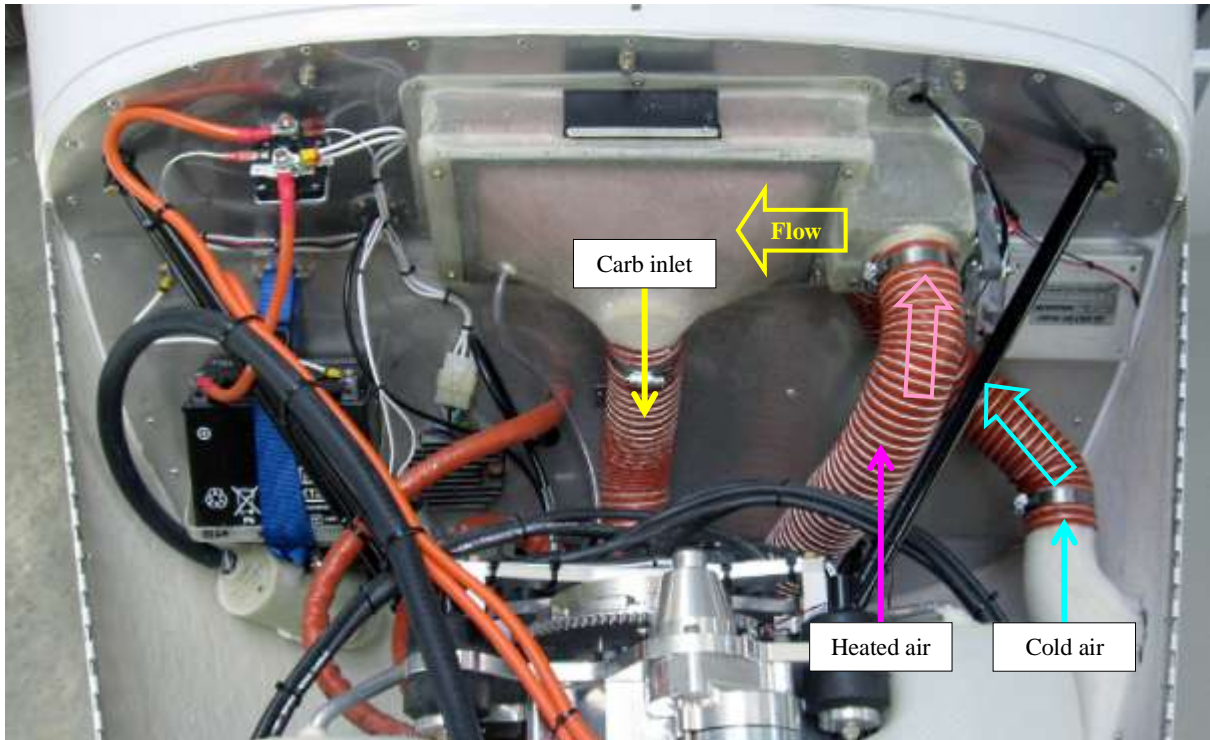

Engine bay viewed from above showing the inlet air hose arrangement

Air is fed into the carburettor from 2 sources, cold and heated, through the air mixer box on the firewall and then into the carburettor air inlet. In each case a scat hose is used to duct the air and each scat hose is held in place with hose clamps.

Start by connecting the air box outlet to the carburettor air inlet: remove the red sealing plug from the carburettor and connect the curved air inlet horn to the mouth of the carburettor and secure with a hose clamp, then cut a short length of scat hose to fit between the horn and the air mixer box outlet and fit it into place. The scat hose should be routed in a smooth curve between the 2 fittings as shown in the photo at right.

Fit a length of scat hose to the lower air inlet fitting on the air box, then hold the lower cowl in position and cut the scat hose to length to fit the cold air inlet fitting on the left-hand side of the cowl. Remove the cowl and set aside for later fitting.

Run a length of scat hose from the fitting on the left rear of the muffler to the front fitting on the air box.

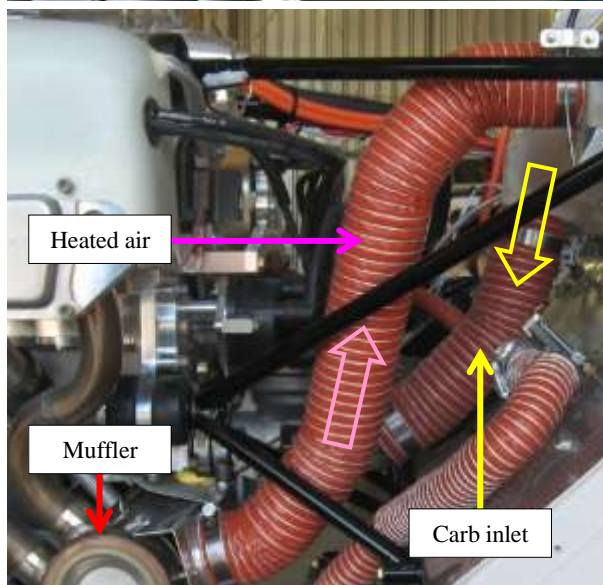
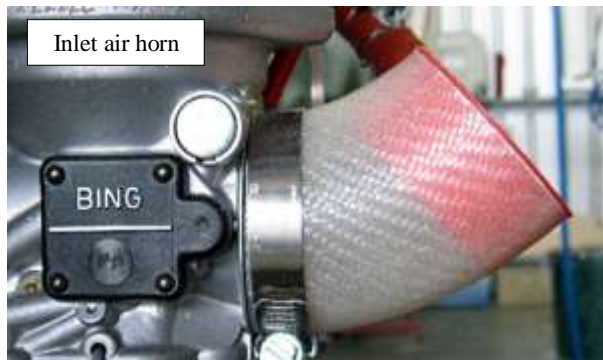

Inlet air ducting as viewed from the right hand side

Fit the equalising tube

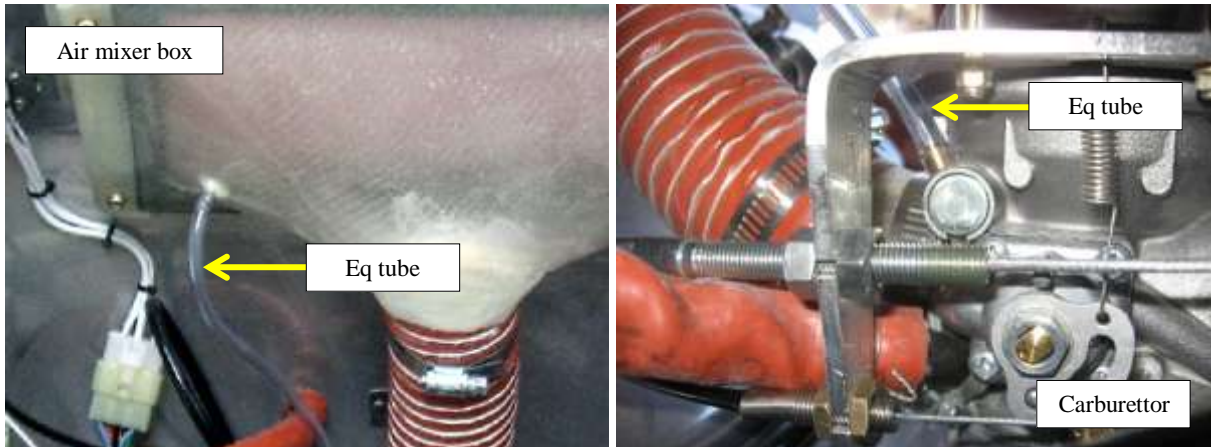

Route a length of 4mm clear tube from the fitting on the right of the air mixer box to the compensator fitting on the right rear of the carburettor as shown in the photos above.

Fit the oil overflow bottle

Clip the oil bottle into the bracket on the lower right of the firewall.

Fit the oil tube from the engine oil filler fitting, along the top engine mount and curve it down to the inlet. Cut the tube to length so that it will not rub on the inside of the lower cowling and fit to the oil bottle with a hose clamp.

Cut a short length of oil tube as shown at right, so that it can be routed over the lower engine mount and down. Fit the short length of alloy tube into the bottom of the outlet tube with a hose clamp then fit the outlet tube to the oil bottle with a hose clamp.

Use the supplied saddle clamp to fit the outlet hose to the firewall as shown at right.

Route the 2 x 4mm clear drain hoses from the fuel pump breather and drain along the lower engine mount and down through the saddle clamp as shown and trim to the same length as the oil outlet tube.



Connect the cabin heater

Route a length of the smaller size scat hose (Card #25) from the top fitting on the heat exchanger to the cabin heat valve on the firewall.

Route a length of scat hose from the cold air inlet in the front left of the lower cowling to the bottom of the heat exchanger unit.

Fit the lower engine cowling into place.

Route the hose along the cowling and secure with zip ties through flocked-on holders as shown in the photo at lower right.

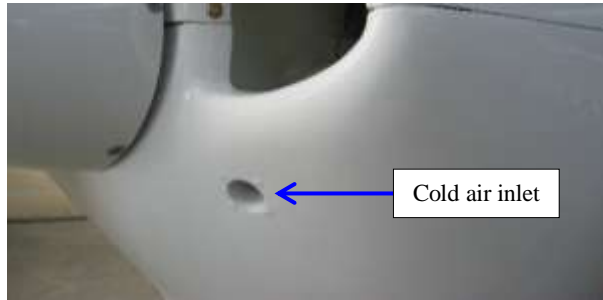

Connect the air inlet hose

Fit the inlet air hose from the NACA duct on the left side of the lower cowling to the air mixer box and secure with a hose clamp.

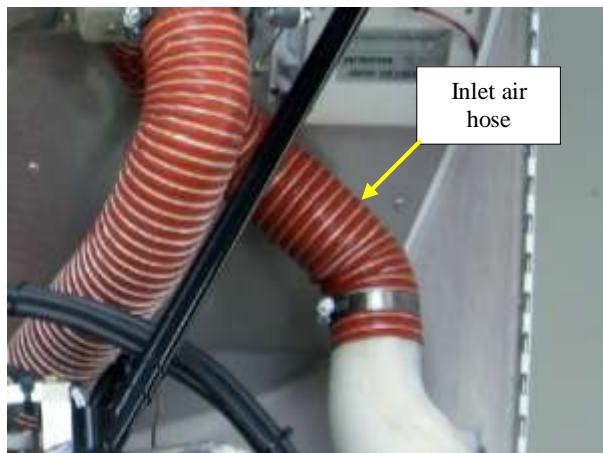

This completes the *Post-Paint>Fuselage>Firewall forward>Final assembly* task.

Post-Paint>Fuselage>Firewall forward>Fit propeller and spinner

Objectives of this task:

In this task the propeller will be fitted to the engine and the spinner will be mounted. The propeller must be fitted before the engine can be rotated or run.

This task covers the fitting of either the Jabiru or Sensenich propeller.

The cylinder compression can cause the propeller to move unexpectedly when rotating the engine and so for safety reasons all spark plugs should be removed and set aside and the spark plug holes should be covered with a clean cloth during this task.

Materials and equipment required:

Card # 23 'Spinner hardware', TorqueSeal inspection putty, small torque wrench

Fit the propeller

Sand both sides of each spinner mounting plate flat in the flange/propeller mounting area.



Turn the engine so that one set of flywheel magnets are at the top (circled above left). This will ensure that the propeller will stop in a horizontal position. Fit the guide bushes from the back of the propeller flange and fit the rear spinner mounting plate over them with the cupped face towards the rear. Fit the propeller so that the upper blade is closest to the 11 o'clock position when viewed from the front of the engine. Tap the bolts through with a soft hammer.



Fit the front spinner mounting plate with the cupped face towards the front, followed by the machined aluminium mounting plate.

On each bolt place pairs of Belleville washers in a 'cup to cup' arrangement: () () (Jabiru prop: 4 pairs, Sensenich prop: 3 pairs) followed by a single flat washer and a Nyloc nut. Tighten the nuts until they are just firm and then torque each nut (**Jabiru prop**: 7 ft/lbs or 9.5 Nm, **Sensenich prop**: 12ft/lbs or 16.25 Nm) working in a diagonal or criss-cross pattern.



There must be more than 1½ threads and less than 3 threads showing through the Nyloc nuts. Pack behind the nuts with flat washers as required. Recheck the torque settings, applying a slow, steady pressure on the torque wrench until the correct torque value is reached.

Add engine oil

At this time the engine should have the correct grade of oil added (2200 = 2.3l, 3300 = 3.5l) refer to the engine manual for the grade. Pour slowly to minimize the chance of spillage and refit the dipstick. Remove the “Do Not Run: Contains No Oil” tag from the engine.

Check and set the propeller blade tracking

It is important that the tips of both propeller blades track *exactly* in line with each other as the propeller rotates – tracking must be adjusted to very close tolerances, preferably less than 0.25mm, in order to minimize engine and/or airframe vibration.

To check the tracking you will need to make up an adjustable pointer (example shown arrowed at right) that can be clamped to the nose gear and placed against the tip of the propeller blade as a reference point (shown circled at right).

Rotate the propeller and check that each tip is just touching the pointer. If there is any variation then the technique to be used is as follows:



Coarse adjustment: if the difference between blades is greater than 1 to 1.5mm then a shim will need to be made and placed between the propeller and the propeller flange.

Remove the propeller. Cut a shim from a sheet of standard 80gsm paper (photocopier paper) as shown at right (use the discarded universal propeller flange as a pattern) and fit on the propeller flange on the side of rearmost blade.



Re-fit the propeller and re-torque all the nuts to the correct values, working in a diagonal or criss-cross pattern, and check the tracking.

Add more shims if required. Note that a shim cut from a manila folder will correct a 2.5-3mm tracking error. Make fine adjustments as described next:

Fine adjustment: if the variation between blades is 1mm or less then apply additional torque of no more than 2 ft/lbs to the 3 nuts on the side of the front-most blade and check the tracking.

When the blade tracking is less than 0.25mm, loosen off all of the nuts and then re-torque them all to the correct values, working in a diagonal or criss-cross pattern.

When blade tracking is correct and all the nuts have been set to correct torque, apply a dab of Torque Seal inspection putty to the top of each nut as shown at right. This gives a clear visual indication that no further work is required.



Pre-fit the spinner

Test fit the spinner – it can be fitted in 2 positions, so try it each way and use the position where the holes all line up the best while giving an even gap around the base of the propeller.

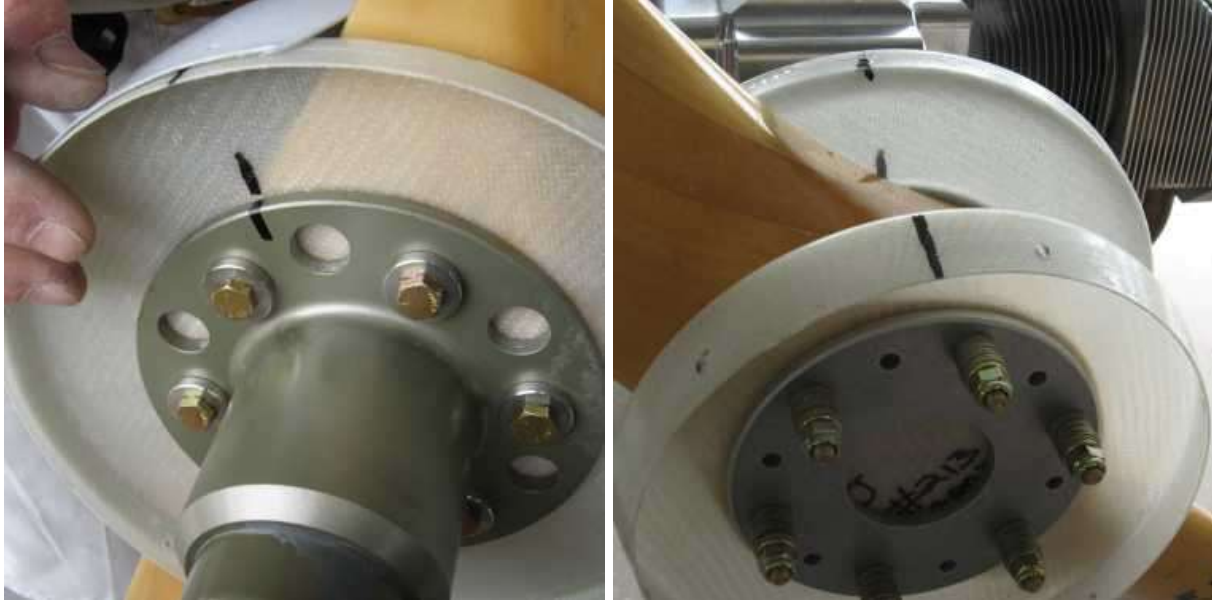

When the mounting position has been decided, mark each component with a permanent marker as shown above so that if there is any need to remove the spinner or propeller all the parts can be refitted in the same position relative to each other.

Fit the spinner in place and line it up with the back of the rear mounting plate and then push a 5/32" pop rivet through all of the holes that line up. Working on one remaining hole at a time, drill a 5/32" hole through the spinner and the rear mounting plate and temporarily place a 5/32" pop rivet in each hole to keep the spinner and the mounting plate in alignment.

Work your way around all 6 holes in this manner. Repeat the process for the 6 holes in the front mounting plate. The spinner should resemble a porcupine at this stage, with pop rivets protruding from the 12 mounting holes. Remove the pop rivets and the spinner and drill all the holes in the spinner out to 3/16" to provide clearance for the screw threads.

Countersink each hole so that the Tinneman washers will sit flush against the spinner.

Fit the captive nuts to the inside of the spinner mounting plates - use the captive nut itself (a complete captive nut assembly is shown below left) as a jig (below right) to drill the rivet holes– thread the screw part way through the captive nut from the back and fit the exposed end of the thread into the hole, then drill the 2 x 3/32" rivet holes.



Countersink the rivet holes just enough to make a countersunk 3/32" rivet sit flush and fix the captive nuts in place and then enlarge the 5/32" holes in the mounting plates to 3/16" to provide clearance for the screw threads.

Fit the spinner

Fit the spinner using 5/32" countersunk screws and Tinnerman washers.



Use a long sanding block to sand the rear mounting plate flush with the rear of the spinner.

Reassembly

Refit the spark plugs – refer to the engine manual for the torque settings. Remember to fit the CHT sensor under the left rear spark plug.

Refit the spark plug leads. Each cylinder pair can only be fitted to the correct cylinder. Push each spark plug cap until it clicks fully home onto the spark plug end.

Refit the ram air cooling ducts: fit and tighten the tappet cover screws and clip the spring retainers to the cylinders.

Check that everything inside the cowling is as it should be – all wiring secure, hose clamps tight, scat hoses all tight, etc.

Refit the top cowling. Fit the piano hinge pins first. The cowl fittings come in 2 lengths: the 3 shorter ones go across the rear of the cowling while the 2 longer ones go each side of the prop hub.

This completes the *Post-Paint>Fuselage>Firewall forward>Fit propeller and spinner* task.

Post-Paint>Fuselage>Fit wheel spats

Objectives of this task:

To final fit the spats or wheel fairings to the main wheels and the nose wheel.

Main wheel spats

Each main wheel spat is held in place by a single bolt on the outside of the spat that fits into the axle extension and 4 screws on the inside that fit to the spat mounting plate.



Fit each spat into position over the wheel and secure with an axle bolt and a flat washer and then fit the inside 3/32" machine screws and Tinnerman washers to the backing plate.

Fit the rubber blanking plug to the tire pressure inspection hole on the outside of each spat.

Nose wheel spat

Support the front of the aircraft so that the nose wheel is off the ground and remove the front axle and wheel. Fit the front of the spat over the yoke and refit the front wheel and the axle, passing the axle through the spat, yoke and wheel as shown below. Fit a flat washer to each side of the axle. Lower the nose wheel back to the ground.

Fit the castellated axle nut and tighten to safety then secure the nut with a lock pin. Screw the spat to the yoke with a short 3/32" machine screw and Tinnerman washer to each side of the spat (arrowed in red in the photo below left).



Fit the rear section of the spat to the front section with 8 x 3/32" machine screws and Tinnerman washers as shown in the photo above right. Fit the rubber blanking plug to the tire pressure inspection hole on the left hand side of the spat.

This completes the *Post-Paint>Fuselage>Fit wheel spats* task.

Post-Paint>Wings>Install aileron cables

Objectives of this task:

To install the aileron cables in the wings. The cable is tied to a pre-installed drawstring and carefully drawn through the wing ribs. This task requires two people: one person to pull the drawstring and a helper to feed the cable into the wing.

Place the cable

The labelled end of the cable is the end that goes inside the cabin, so the unlabelled end is the end that goes out through the wing to the aileron. This task will describe feeding the cable in from the wing root and out of the aileron access hole.

Fit a rod end to the unlabelled end of the cable – the rounded end will aid the passage of the cable through the high-density foam ribs – and push the inner cable all the way in towards the labelled end of the cable. This will make the pulled end of the cable shorter and thus it will be more flexible to follow the curved path inside the wing (refer to the second photo below).



There is a drawstring inside in the wing with extra string coiled around a stick at the aileron end that will be visible through the aileron cable inspection opening. Loosen the drawstring and check that it can be moved freely, then pull a short length out of the wing root (circled above) and tie it firmly through the rod end. Wrap cloth tape around the cable end from the rod end all the way back to the outer cable: this will ease the cable through the wing ribs.

The aileron cable runs along the rear of the wing and then curves around and back and emerges at the aileron drive arm position as shown in the drawing excerpt of the outboard end of the wing at right:

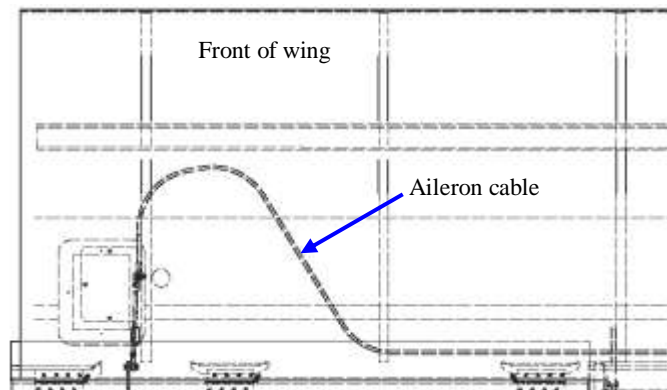

Have your helper feed the cable into the wing while you pull gently on the drawstring through the aileron cable inspection opening. Work slowly and do not apply too much pressure but rather move the cable carefully and shake it if it seems to catch at any time.

It will help if your helper can slowly rotate the outer cable while you ease the cable around the curve at the outboard end of the wing. Do **not** pull strongly on the drawstring: if you do you will only succeed in cutting the string into the foam ribs and wedging the cable, which will make it extremely difficult to complete the task.

Feed the cable through the wing until it can be pulled through the aileron cable inspection opening, then discard the cloth tape and string and remove the rod end.

Push the cable back into the aileron cable inspection opening and pull the end of it out of the aileron cable slot in the upper surface of the wing.

Connect the aileron cable

The cable is held to a strengthened rib inside the wing by a saddle clamp and 2 x AN3 bolts and Nyloc nuts. Access is from the aileron cable inspection opening and the 38mm hole beside it: the bolts are fed through from the back of the rib (through the 38mm hole) and then the clamp backing plate goes against the rib, then the cable and then the saddle bracket with the aligning indentation fitting into the slot on the outer cable and the assembly is held in place with Nyloc nuts. Check that the cable is correctly positioned and tighten both nuts firmly. Mark each nut with *TorqueSeal* or similar.

Fit the inspection cover

At this time you can fit the clear acrylic inspection cover to the inspection opening.

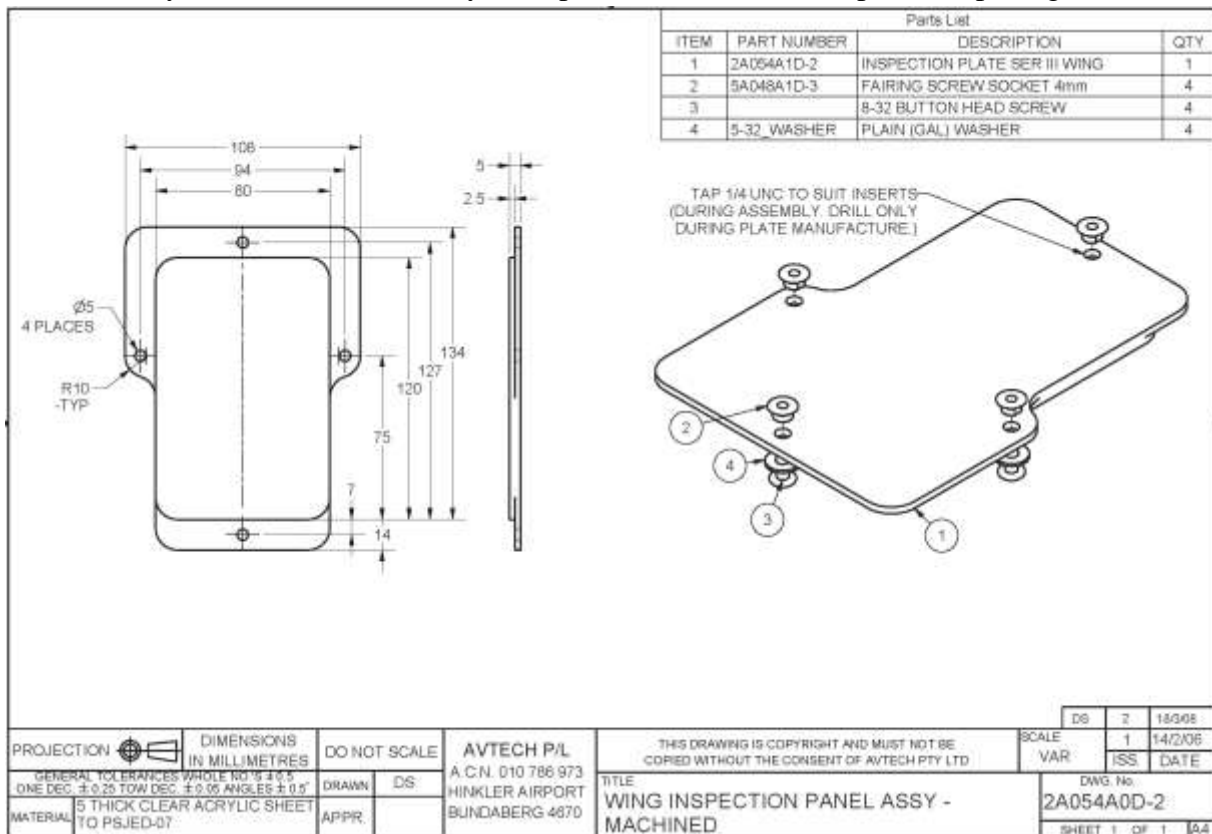

Fit the threaded fairing sockets to the inspection cover and then position the cover inside the wing and fix in place with 8-32 button head screws, all as shown in the drawing above.

This completes the *Pre-Paint > Wings > Install aileron cables* task.

Post-Paint>Wings>Fit stall warning

Objectives of this task:

To fit the stall warning device to the left wing.

Materials required:

Card #6: 'Stall warning'

5-minute Araldite and flock

Mark and drill the wing root

Mark a position in the left-hand wing root 75mm back from the leading edge and drill a 10mm hole at that location in line with the wing attach bolt hole in the front lug. The clear plastic stall warning tube will enter the wing here.

Assemble the stall warning

Use 5-Minute Araldite and flock to fix the aluminium stall warning funnel to the plate, about 4mm back from the front edge, and then cut the stainless steel gauze to size and flock it by the edges to the front of the funnel as shown at right. Leave to cure, then round the front edges of the plate carefully. Roughen the sides and bottom of the assembly.

Mark and cut the leading edge

Measure out 1195mm from the wing root of the left-hand wing and mark the location. Use cloth tape to protect the paint on the leading edge of the wing during this step.

Using the drawing on the next page, locate the vertical centre of the stall warning aperture and mark the location. Recheck your measurements carefully and drill a pilot hole, then widen the hole to 10mm and file carefully out to a rectangle 12mm high and 19mm wide. The top of the opening should be *precisely* on the leading edge of the wing. Final size the hole to fit the stall warning assembly.

Hold the lip at the bottom of the assembly with pliers while fitting – be careful not to drop it inside the wing.

Fit the stall warning assembly

Use a steel rod to feed the plastic tube in from the wing root and through the wing ribs until it can be seen through the hole in the leading edge, then pull the tube through using a wire hook and superglue and lock wire the tube to the rear of the stall warning funnel.

Apply 5-Minute Araldite and flock to the bottom and sides of the stall warning assembly and carefully slide it back into the wing until the gauze is flush with the leading edge of the wing and leave to cure. Remove the protective cloth tape.



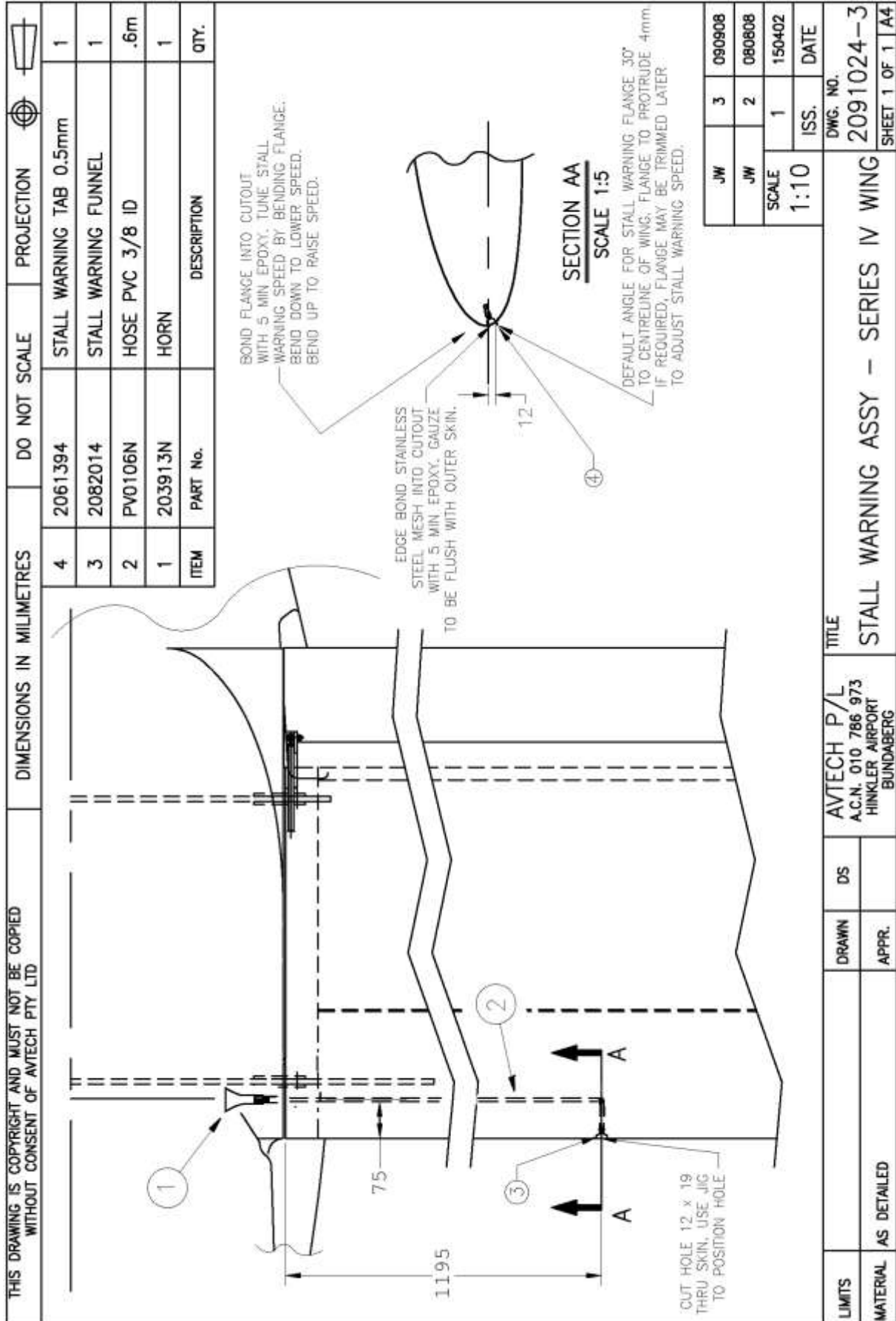

This completes the *Post-Paint>Wings>Fit stall warning* task.



Post-Paint>Wings>Prepare wings for fitting

Objectives of this task:

To prepare the wings prior to fitting them to the fuselage.

Materials required:

Resin and flock

Card #16 'Flaps'

Prepare the flaps

Run a 3/16" drill through the bolt hole in each flap hanger to clear any paint and debris out of the holes. Clean out the 1/4" holes in the flap pivot arms in a similar manner.

The flaps will be fitted to the wings after the wings have been fitted to the fuselage.

Fit the ailerons

Hold the aileron in place and slide the hinge pins through each hinge, starting from the side of the hinge where the pin retaining slot was filed in the *Pre-Paint>Wings>Fit ailerons* task.

Fit the pin retainers and hold them in place with a 5/32" machine thread screw.

Place the ailerons in the neutral position and place a length of cloth tape over the top surface of the wing and the aileron. This will prevent the ailerons from dropping when the wing is turned right way up.

Turn the wings over so that they are right way up.



Fit the aileron cable rod end to the aileron drive arm with an AN3 bolt fitted through the drive arm, then an AN960-416 (3/16") flat washer, then the rod end followed by an AN960-515 (1/4") flat washer and a Nyloc nut as shown in the photos above.

Tighten the Nyloc nuts to safety and mark with *Torque Seal*.

Fit the fuel gauges

Remove the masking tape from over the fuel gauge boss in the wing root and clean the area.

Test fit each fuel gauge – feed the float unit into the wing tank and hold the gauge in place with 2 screws. Check the empty indication – the needle should sit slightly below the “E” or “Empty” mark as shown in the photo at top right.



If it does not then the gauge will need to be adjusted.

The gauge needle is driven by a magnet that is turned by the action of a float that sits inside the fuel tank. The gauge can be disassembled by pulling the black nylon float drive out of the aluminium gauge body and the magnet can be twisted slightly by hand. See the photos below for detail of the gauge unit.

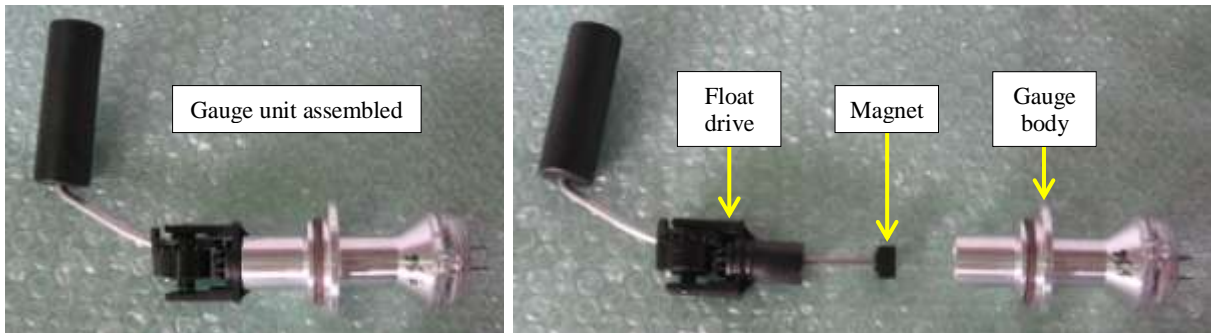

The gauge can then be reassembled and rechecked (and readjusted if necessary) until it reads correctly.

The nylon drive unit barrel should be a firm fit into the gauge body: if the fit is not entirely to your satisfaction then a smear of Loctite 577 *Sealant* should be applied to the barrel.

When the gauges are fitted each of the 4 retaining screws and the top and bottom gauge face screws should have a small drop of Loctite 242 *Threadlocker* applied before fitting.

Carefully bend the electrical spade terminals out so that they are parallel to the face of the gauge as shown circled at right.



Fit the fuel tank connector blocks

Fit the tank connector blocks through the slots in each side of the fuselage and push each connector block fully forward in the slot.

Use the supplied layer plate as shown in the photo at right to hold the connector blocks in the fully forward position and fix to the fuselage with 2 x 8G stainless steel self-tapping screws.



Fuel lines and fittings



There are 3 fuel lines that need to be connected in the wing root: the bottom 2 carry fuel to the header tank while the top line is the breather for the header tank. These fuel lines each need to be fitted and then cut to an approximate length of 300mm behind the rear of the wing.

All 3 lines exit the wing root towards the rear and both of the fuel lines will have a spring fitted to prevent any chance of a kink developing when the lines are bent to the rear, while the breather line faces rearwards already.

Fit each fuel line to the tank fitting and secure with a hose clamp. Slide a 100mm length of spring over each fuel line, push all the way up to the hose clamp and fix in place with silicone sealer at the hose clamp end as shown in the photo at right.



Label the other end of each fuel line with tape as shown at right. This is essential because once the wing has been fitted it will be *very* difficult to determine which line is which if it has not been labelled.



“**B**” = breather line

“**F**” = front fuel line

“**R**” = rear fuel line

Fit the fuel gauge windows

Locate the clear, round fuel gauge windows and Superglue them over the outside of the fuel gauge holes in the wing root area of the fuselage.

Fit the vent tubes to the fuel filler caps

The fuel filler caps came partly assembled on the card and were fitted to the fuel filler opening on the wing in the *Pre-Paint > Wings > Prepare wing root* task to keep dirt out of the wing tanks, all that remains now is for you to fit the vent tubes to the fuel caps.

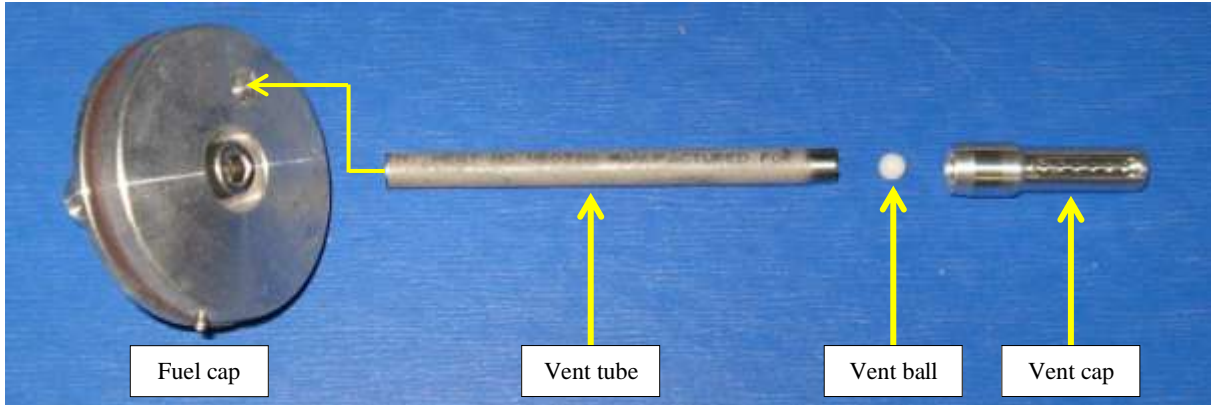

Working on one wing at a time, remove the fuel cap and place a clean cloth or a piece of tape over the fuel filler opening so that no dirt or debris can fall into the tank during this process. Start by carefully cleaning away any paint from the top of the fuel cap and in particular from the vent tube hole in the top of the cap.

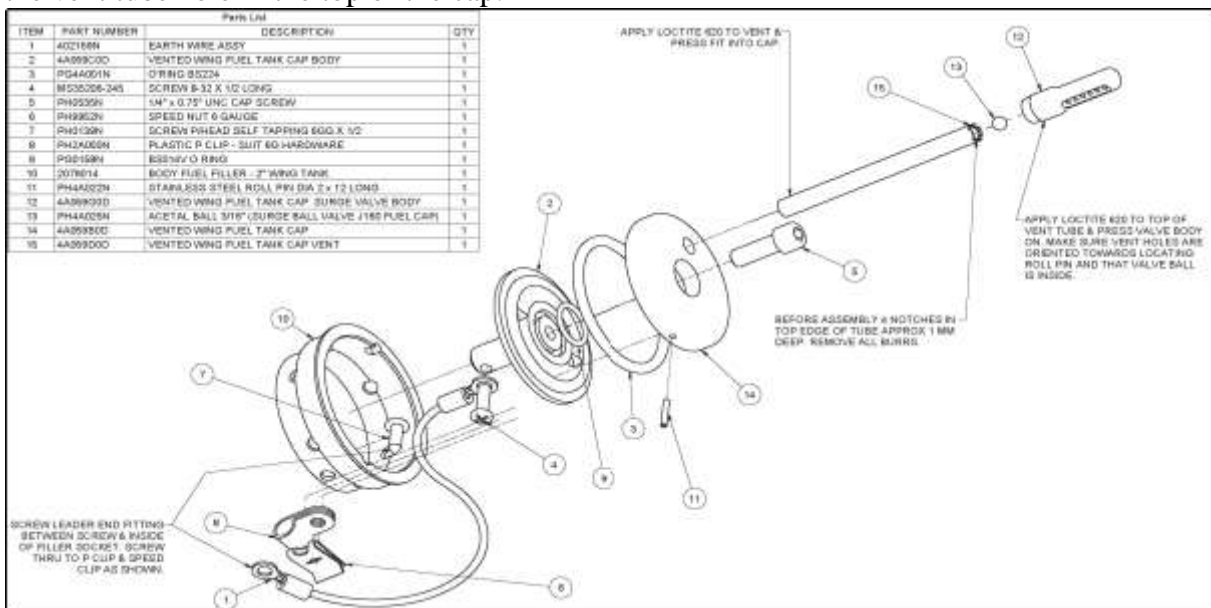

Use a file to cut 4 notches each 1mm deep into the top of the vent tube. Remove all burrs.

Fit the notched end of the vent tube to the vent cap – the vent tube should be a snug fit into the vent cap, use fine sandpaper if required to size the tube to a good fit. Now, working upside down, drop the small white vent ball into the vent cap and use a smear of Loctite 620 to fix the vent tube into the vent cap. Make sure that nothing has caught the vent ball – the ball should still rattle in the vent cap when the assembled tube and cap is shaken.

Fit the vent tube to the hole in the top of the cap – the vent tube should be a snug fit into the hole, use fine sandpaper if required to size the tube and then fix it in place with Loctite 620 with the breather holes in the vent cap facing towards the outside of the fuel cap.

This completes the *Post-Paint > Wings > Prepare wings for fitting* task.

Post-Paint>Wings>Fit wings

Objectives of this task:

To final fit the wings to the fuselage. This is a repeat of the *Pre-Paint* task but because you have already pre-fitted the wings they can now be fitted into place more easily. This task will discuss the fitting of one wing at a time.

In our factory we use 3 people for this task, so ask 2 friends over to help you.

Do **not** try to do this task with less than 3 people or you risk dropping the wing.

Preparation

Place 2 trestles beside the fuselage and lay the wings on them.

Fit the bottom of the strut to the lower fuselage mount and secure with an AN175-15A bolt inserted from the front and an AN960-516 washer MS20365-528 nut. Rest the outboard end of the strut against a saw stool as shown at right.

Lay the AN4-14A wing attach bolts and some AN960-416 washers on top of the fuselage where you can easily reach them.



Fit the wing



One person holds the outboard end of the wing while the other 2 hold the front and back of the wing root as shown in the photo above.

Carefully walk the wing in to the fuselage, feeding the aileron cables through the fuselage holes and feeding the fuel lines, stall warning tube and any electrical wiring, and guide the wing attach lugs on the wing into the aluminium wing attach brackets on the fuselage.

The fit between the wing attach lugs on the wing into the aluminium wing attach brackets will be tight and it may take some careful positioning of the wing to get them to fit – the outboard end of the wing may need to be moved forward or backwards to get the correct alignment.

Each AN4-14A wing attach bolt should be fitted with one AN960-416 washer under the head of the bolt and one AN960-416 washer under the nut.

It will be necessary to gently tap the AN4-14A bolts into place – tap in until the head of the bolt is seated hard against the aluminium wing attach bracket and then put an AN960-416 washer and a MS20365-428 nut and tighten up until the nut is in safety: there should be at least 1½ threads showing through the nut but not more than 3 threads showing.

DO NOT OVERTIGHTEN THESE BOLTS. They should be just tight enough to prevent rotation. Over tightening may result in failure of the wing attach lugs.

Fit the strut



When both wing attach bolts are in place, lift the strut up to the underside of the wing and fit the strut to the wing with an AN175-15A bolt inserted from the front and an AN960-516 washer MS20365-528 nut and tighten up until the nut is in safety: there should be at least 1½ threads showing through the nut but not more than 3 threads showing.

DO NOT OVERTIGHTEN THESE BOLTS. They should be just tight enough to prevent rotation. Over tightening may result in failure of the strut attach lugs.

Repeat the fitting process for the other wing.

Fit the stall warning horn

Trim the stall warning tube to length and fit the stall warning horn to the end of the tube.

Hold the stall warning horn to the cabin upholstery with Velcro strips.

Test by sucking on the stall warning in the leading edge of the wing until you hear the horn.

This completes the *Post-Paint>Wings>Fit wings* task.

Post-Paint > Wings > Connect ailerons

Objectives of this task:

To connect the aileron cables and set the aileron deflections. One person can do this task but it is much easier with 2 people: one to position the ailerons and one to make the adjustments.

Fit the outer cables

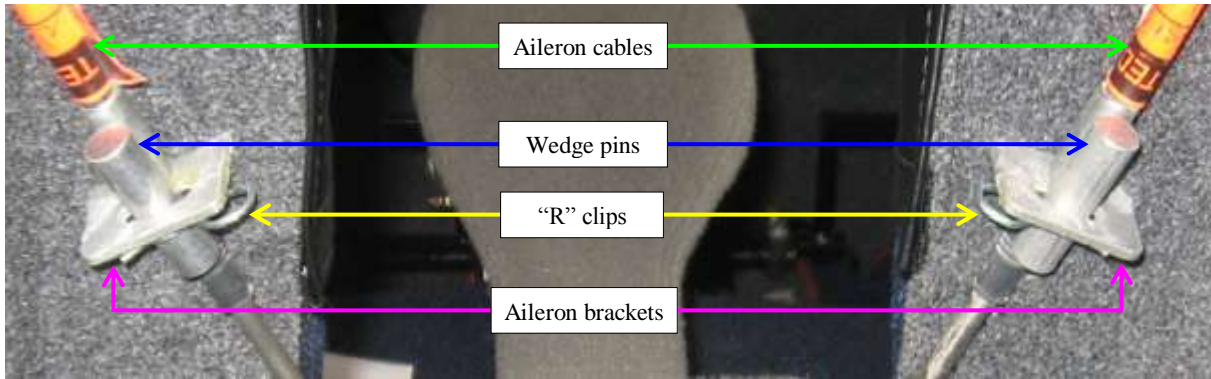

Feed each aileron cable through the same side bracket in the seat back: the left-hand cable through the left-hand bracket and the right-hand cable through the right-hand bracket.

Fit the groove in the outer cable into the shaped hole and push the cable forward so that the cable seats into the bracket, then fit the retaining wedge pin in behind the cable, push the wedge pin firmly down and secure it in the bracket with the retaining spring clip as shown at right.

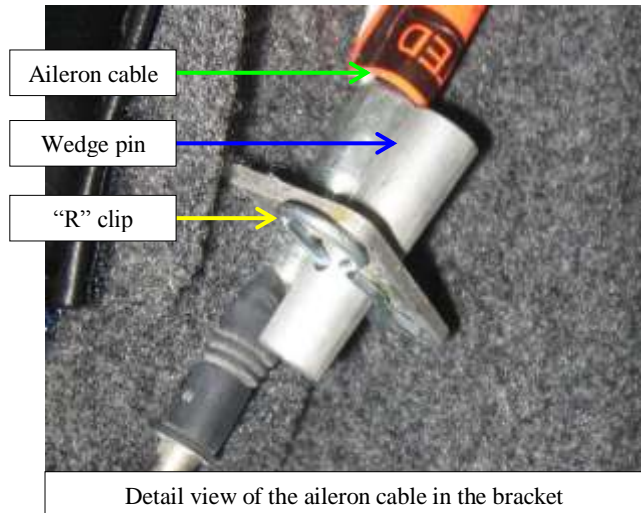

Set the ailerons to the neutral position



Set the ailerons to the neutral position: a straightedge held under the wing must touch the front and back of the wing and the back of the aileron as shown arrowed in the photo above.

Keep the straightedge handy – this setting will need rechecking several times.

Set the aileron cable lengths

Loosen off the lock nuts on the rod ends at both ends of each aileron cable.

Set the control stick so that it is centred laterally/from side to side.

Check that both ailerons are still set to the neutral position and then carefully adjust the rod ends on each aileron cable by hand so that an AN3 bolt can be fitted through the rod end and the aileron bellcrank on each side.

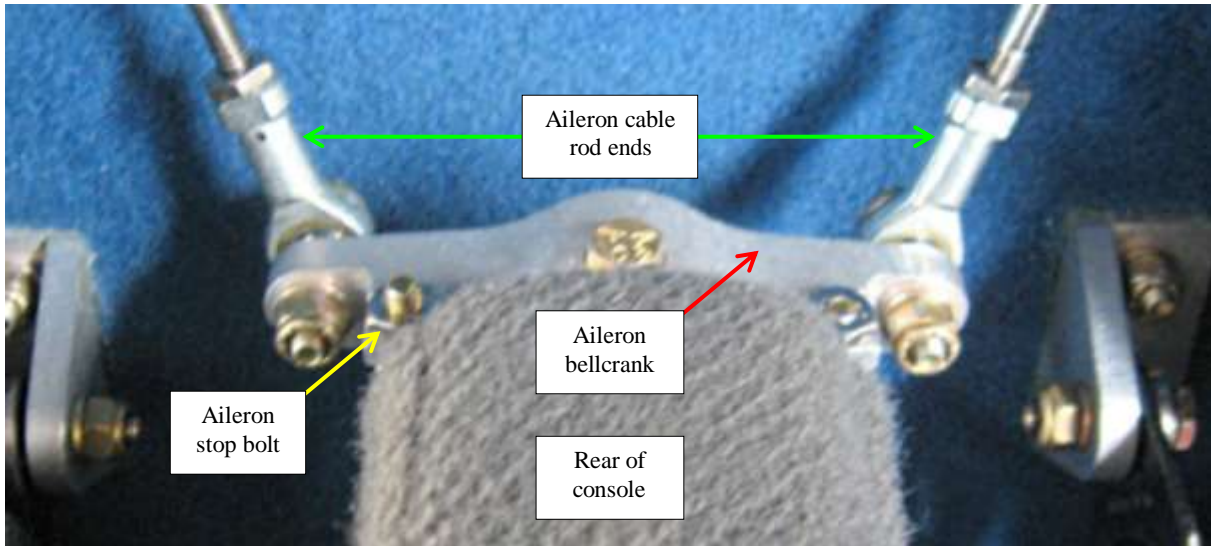

It may be necessary to adjust the cable length at both ends of the cable, and ideally the rod ends should be adjusted to be close to equal with the same amount of thread showing at each end of the cable. Work on one side at a time and check that the aileron is still neutral and the stick is still centred, then move to the other side.

Take your time with this step: it is easy to bump the control stick slightly while testing cable lengths and it may be necessary to repeat the process several times until both ailerons are set to neutral and the cable lengths are both correct.

Ensure that the inboard end of the aileron cables are connected to the **same side** of the aileron bellcrank at the rear of the control column: the left wing cable **must** connect to the left side of the bellcrank and the right wing cable **must** connect to the right side of the bellcrank.

When both aileron cable lengths have been set with the ailerons in the neutral position and the stick centered, fit the rod ends to the aileron bellcrank with an AN3 bolt. Fit an AN960-515 (1/4") flat washer, then the rod end followed by an AN960-416 (3/16") flat washer, then the bellcrank, another AN960-416 (3/16") flat washer and a Nyloc nut.

Tighten the Nyloc nuts to safety and mark each nut with a dab of *TorqueSeal*.

Tighten the rod end locknuts at each end of each aileron cable firmly and mark each locknut with a dab of *TorqueSeal*.

Set the aileron deflections

Once the aileron cables have been adjusted to length with the ailerons in the neutral position and the stick centred, the full travel deflections can be set.



In the kit there is an aileron deflection template. Place this template on top of the wing and set the aileron to the full UP travel deflection as shown in the photo above (note the 3 arrowed points where the template touches) and then adjust the stop bolt on the aileron bellcrank so that the bolt just touches the eccentric stop at full deflection.

The eccentric stop that you fitted in the *Post-Paint>Fuselage>Interior>Fit console controls* task can be rotated if required to give an equal length to the stop bolts.

Repeat the process for the other aileron and tighten the stop bolt locknuts.

Final check

Recheck each step:

Check that the outer cables are firmly fixed into the brackets by the wedge pins and that the wedge pins are held by the “R” clips;

Centre the control stick and check that both ailerons are in the neutral position. Make minor adjustments as required;

Check that the aileron stops are set correctly for full deflection: when the control stick is at full left deflection the left aileron should touch the aileron deflection template at all 3 points and when the control stick is at full right deflection the right aileron should touch the aileron deflection template at all 3 points. Make minor adjustments as required;

When all of the settings are correct check all 4 rod end lock nuts (2 on each cable) and the 2 aileron stop lock nuts for tightness and mark each one with a dab of *Torque Seal*.

This completes the *Post-Paint>Wings>Connect ailerons* task.

Post-Paint>Wings>Connect wing tanks

Objectives of this task:

To connect the fuel lines and earth the wing tanks to the fuel system.

Size and connect the fuel lines

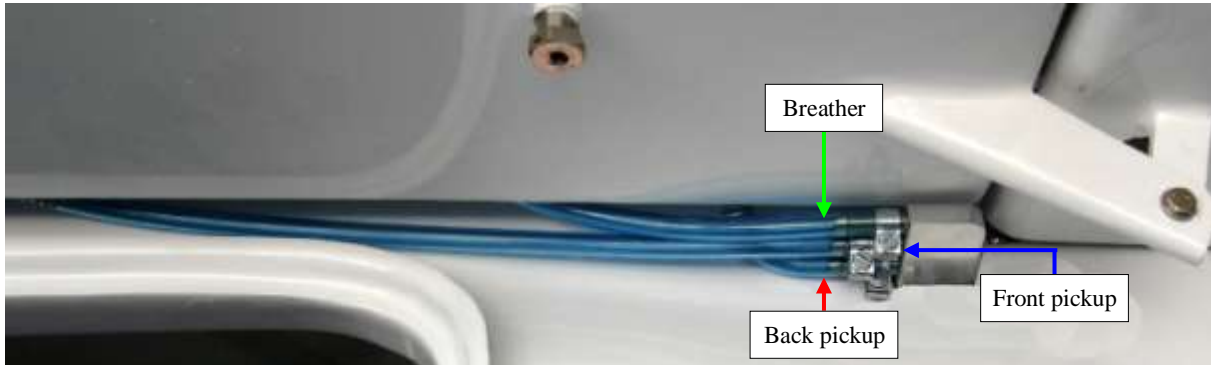

Hold the fuel lines under the connector block and cut each line to length so that they can be fitted to the connector block as shown above. There must be no kinks in any fuel line.

As you can see from the photos above and at right (taken from the *Pre-Paint>Fuselage>Interior>Fuel system* task) the back fuel pickup goes to the inside ferrule, the front fuel pickup goes to the middle ferrule and the breather goes to the outside ferrule.

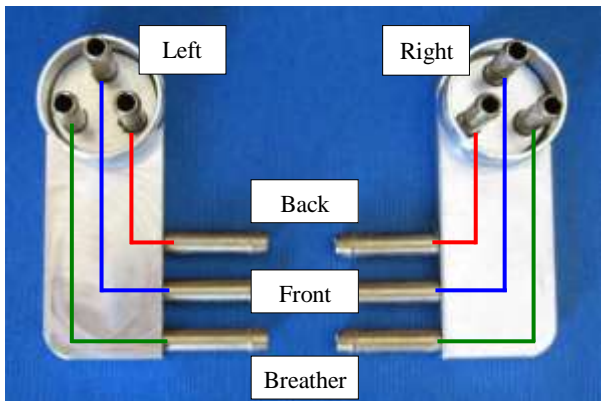

Working from the inside line to the outside, hold each fuel line in place with a hose clamp and tighten each clamp firmly.

Route the earth wires

Run a length of white aviation wire from the front of each wing, through the aileron hole in the fuselage and into the top of the fuel line sheathing from each wing tank. Run the wire all the way down into the header tank enclosure and leave enough length to connect to the common earth post in the floor of the enclosure.



Crimp a red ring terminal to the bottom of each wire and fit to the common earth post in the header tank enclosure (arrowed at right) – the same earth post that connects the earth from the fuel pump and the quick-drain fitting on the header tank. The top of each earth wire will be connected to the quick-drain fittings on each wing after the wing root fairings have been fitted in the *Post-Paint>Wings>Fit fairings* task.

This completes the *Post-Paint>Wings>Connect wing tanks* task.

Post-Paint > Wings > Fit flaps

Objectives of this task:

To fit the wing flaps to the wings and adjust their deflection. We use 2 people in the factory to carry out this task and we recommend that you do the same as the flap is too long for one person to handle and there is a risk of damaging the painted surface of the flap and the wing.

Materials required:

“Wotan” cloth tape to hold the flaps up while adjusting the flap push rod lengths.

Fit the flap push rods to the flaps

Fit a rod end and plain locking nut to one end of each flap push rod and tighten the lock nuts firmly. Lay the flaps upside down on trestles and fit the flap push rods to the inboard end of each flap.

Working through the access hole in the flap, feed an AN3-13A bolt with an AN960-416 (3/16”) flat washer under the head from the inside of the flap through the drive post.

Fit 3 x AN960-416 (3/16”) flat washers, then the rod end and an AN960-515 (1/4”) flat washer and a Nyloc nut as shown in the photo at right. Tighten the nut to safety.

The flap push rods should now be centred in the slot in the leading edge of the flap.

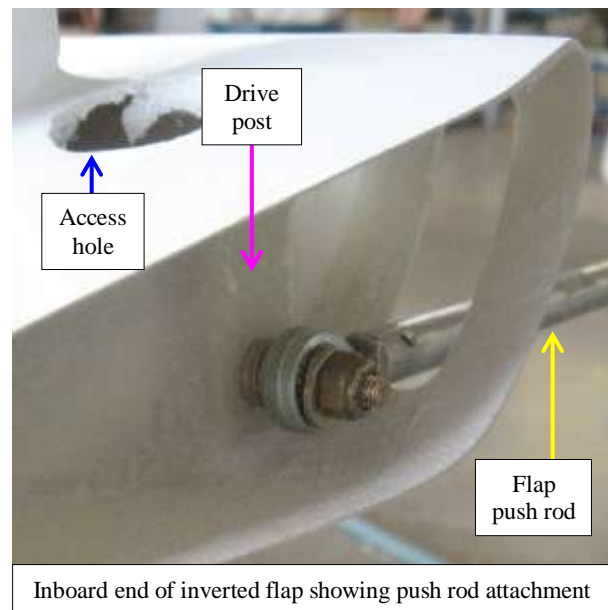

Fit the flaps to the wings

Each flap post bolt hole has a short length of Bundy tube spacer fitted inside (*tip*: a smear of grease will hold the spacer in place while fitting) and the flap post fits into the flap hanger and is then secured with an AN3-8A bolt.

Working on one flap at a time, fit the flap to the wing with the AN3 bolts with a 3/16” flat washer under the head of each bolt. Fit a 3/16” flat washer and Nyloc nut and tighten each nut to safety. Check that the flap can be extended and retracted by hand, taking care not to scratch the fuselage or the side window when the flap is near full deflection.



Hold a straightedge under the wing and flap with a gap equal to 2 mixing sticks at the rear of the wing and touching at the front and back, all as shown in the photo above.



Tape the flap into position with a length of cloth tape as shown arrowed in the photo at right.

Fit and set the other flap in the same manner.

The flaps are now in the fully retracted position and are ready for the flap push rods to be connected to the flap drive arms in the next step.



Connect and adjust the flaps

Apply power to the flap motor and extend the actuating shaft fully as shown at right.

Fit a rod end with a plain locking nut to the free end of the flap push rods and screw the rod end into the flap push rods until the hole in the rod end lines up with the hole in the flap drive arm, then fit the rod end into the clevis in the flap drive arm as shown below right with an AN3-10A bolt with a 3/16" washer under the head of the bolt and another 3/16" flat washer and a Nyloc nut and tighten the nut to safety. Tighten the plain locking nut firmly.

Repeat the process for the other flap. At this point the flaps have been fitted and adjusted.

Apply power to the flap motor and extend the flap to the first position and check both flaps for clearance from the fuselage.

Have someone watch each flap as you continue to extend the flaps to the second "full flap" position and check each flap for clearance from the fuselage until the full flap position is reached.

If you set your flap end clearances correctly in the *Pre-Paint > Wings > Test fit wings* task there should be no problems, but if the flaps do touch the fuselage then you will need to remove the flap and cut the end of the flap away to maintain a 5mm clearance from the fuselage.



This completes the *Post-Paint > Wings > Fit flaps* task.

Post-Paint>Wings>Fit fairings

Objectives of this task:

To fit the final trim: specifically the wing root fairings, the upper strut fairings, the lower strut/main gear recess fairings and the wheel spats.

Wing root fairing

The wing root fairing comes in 2 parts: upper and lower. Fit the lower fairing first – tape the fairing into place with the fairing just touching the fuselage and then screw the fairing to the wing with 5 x evenly-spaced 6G stainless steel self-tapping screws.

Fit the fuel block fairing to the lower fairing with 2 x 6G stainless steel self-tapping screws.

Fit the top fairing with the front return overlapping the lower fairing and screw in place in the same manner.

Repeat the process for the other wing.

Refer to the photos at right for details of placement and screw spacing.

Wing tank earth

Fit a length of lock wire to the quick-drain fitting under the wing and long enough to reach the rear fairing screw and twist it.

Crimp a red ring connector to the lock wire.

Trim the white earth wire that you fitted in the *Post-Paint>Wings>Connect wing tanks* task so that it reaches the rear fairing screw and crimp a red ring connector to it. Fit both ring connectors under the rear fairing screw and tighten the screw firmly.

Repeat the process for the other wing.

Strut to wing fairing

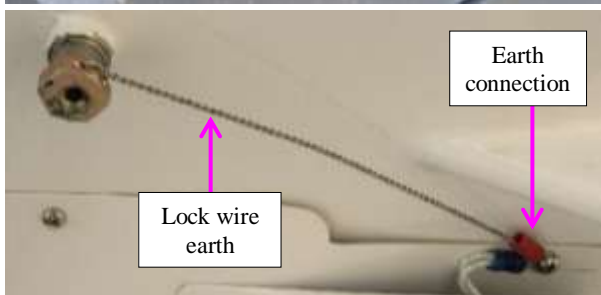
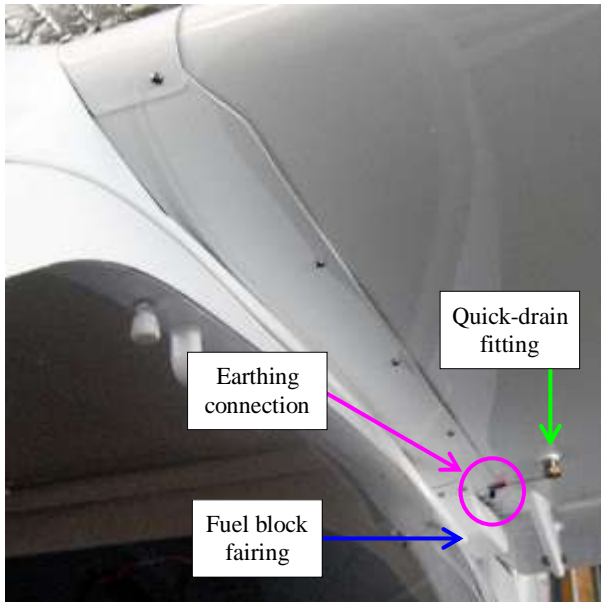

Fit the front section of the fairing into place with 6G stainless steel self-tapping screws as shown in the photos above. Repeat the process for the other wing.

Lower strut/main gear fairing



Right hand side strut/main gear fairing from below (top photo) and side on (above)

Start by tucking the brake lines up into the main gear recess and zip tying them to the top rear of the main gear legs. Connect the pitot line from the right hand strut to the instrument panel line with a blue water trap connector and tuck the pitot line up into the main gear recess.

Fit the right hand section first: tuck the blue water trap connector into the fairing and then fit the fairing into place and hold it there temporarily with some cloth tape while you fit the 5/32" machine screws and washers, then fit the left hand section in the same manner.

This completes the *Post-Paint > Wings > Fit fairings* task.

CONGRATULATIONS, you have completed construction!!

Now, on to *Testing*.



Testing>General

Here we are: the *Construction* phase has been completed and the task in hand is to thoroughly check the aircraft in preparation for flight and then, finally, test fly the aircraft for first time.

Many tasks need to be completed prior to the first flight:

- The aircraft must be carefully Weighed and Balanced and, if necessary, rebalanced to suit your intended loadings and the information recorded in the Owners Manual;
- The Rigging (the deflection of the control surfaces) must be rechecked – each deflection was set as part of the relevant *Post-Paint* tasks so this is essentially confirming your earlier work and making minor adjustments if required;
- The Fuel Gauges will need to be calibrated so that you will have an accurate indication of fuel quantity;
- You will need to affix the required placards and decals as listed in Section 2.8 of the Owners Manual;
- You will need to fit the Registration Markings required by your country's aviation authority;
- An extensive Pre-Flight Checklist must be completed: this checklist runs to 15 pages and to complete it correctly will take you several days;
- And finally the Test Flight, which will require a disciplined approach and which should be conducted by a suitably experienced pilot.

Resist any temptation to rush these final tasks; it is ***extremely important*** that all checks be completed correctly before flight is attempted. Failure to do so could have severe consequences, so take your time and be ***very thorough!***

So there is still quite a bit of work to do, but you are within a week or 2 of finishing your build, depending of course on how much time you can devote to these tasks.

This would be a good time to have a clean-up of both the aircraft and your workshop:

- Clean the aircraft interior: remove anything that is not part of the aircraft (tools, rags, sandpaper, etc) and vacuum out any dust and dirt.
- Wash the exterior with clean water with a little soap (most car washing products are suitable) and chamois dry.
- Clean the windscreen and windows carefully and if necessary use some Novus products (refer to *Post-Paint>Fuselage>Fit doors* for details) to clear any minor marks or scratching.
- Clean your work area thoroughly and organise your tools.
- Locate your deflection templates: you will need them shortly.

OK, let's get on with it – the end is in sight!



Testing > Weight and balance

Objectives of this task:

To calculate the *Empty Weight* and the balance point or *Centre of Gravity* of the aircraft.

The *Empty Weight Trim Index* is calculated from these values and then various loading scenarios are tested to see if any rebalancing of the aircraft is required. Finally all values are entered into the *Aircraft Empty Weight Record* in Section 6.2 of the Owners Manual.

Equipment required:

3 bathroom scales capable of weighing up to 150Kg

Plumb bob and string line, set square

Builders type spirit level

Chalk and a builders chalk line to mark the reference positions onto the hangar floor

Prepare the equipment

Before you do anything else, check your scales for accuracy: use some objects of a known weight, such as a few 20Kg bags of cement to see if your scales are reading correctly at around the 100Kg range of the scale.

If there is a problem then either adjust the scale or, if this is not possible, note how much the scale over/under reads and apply this as a correction to the weight displayed.

Prepare the aircraft

Remove all surplus items from the cockpit: tools, clothing, etc. and clean the interior of the aircraft with a vacuum cleaner. Clean the exterior of the aircraft: remove all dust and dirt with a damp cloth. Check that the engine oil is full to the bottom of the hatched marking on the dipstick. Turn the fuel tap on the console to the OFF position (lever facing up).

Fill the header tank with fuel but leave zero fuel remaining in the wing tanks.

The aircraft should contain everything required for flight except fuel in the wing tanks.

Reference points

In this task you will be measuring the horizontal distances from the *Datum*, which is the leading edge of the wing, to the main wheel axles and the front wheel axle.

Each reference point will be marked onto the hangar floor and then measured.

Mark and measure

Refer to the drawing on the next page for colour-coded details of the line markings.

Use a chalk line to mark 2 lines at least as long as the aircraft on the hangar floor in a right angle cross. Roll the aircraft directly along one line (coloured **blue** in the drawing) until the main wheels are directly over the second line (coloured **green** in the drawing).

The main wheel axles must be **directly** over the second (**green**) line: use a square or a plumb line from the axle bolt centres in the main wheel spats to check this and move the aircraft as required. Leave the brakes off and chock the main wheels when the position is correct.

Mark the *Datum* line (coloured **purple** in the drawing) on the floor by means of a plumb line hung from the leading edge of each wing, using a point about 300mm outboard of each main wheel. Join both *Datum* line marks and mark a line across the floor with your chalk line.

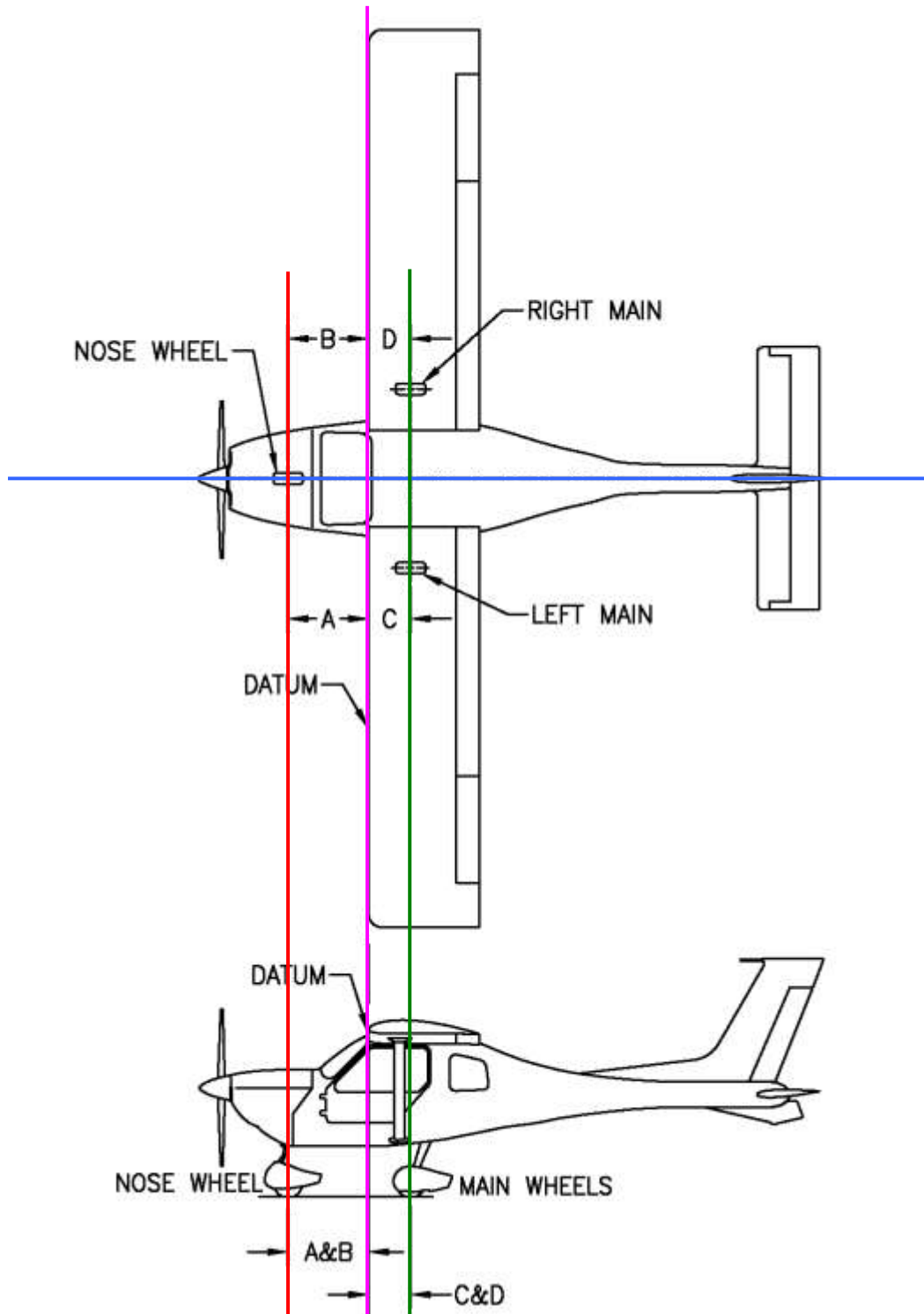

Mark a point on the floor directly under the centre of the front axle bolt on each side: use a square or a plumb line from the axle bolts in the front wheel spat to check this.

Now measure the distance from each side of the front axle (the **red** line above) to the *Datum* line: these are distances **A** and **B**. add them both together and divide by 2 to get the average distance – this will compensate if the front wheel is not set exactly straight ahead. Enter the distance as a negative value in the *Distance to Datum* column on the chart on the next page.

Measure the distance from the **left** main wheel axle to the *Datum* line and enter the value at distance **C** in the chart on the next page. Do the same for the **right** main wheel (distance **D**).



Examples of calculation

Below is an example calculation showing typical values:

Item	Weight (kg)	X Distance to Datum (mm)	= Moment (kg/mm)
Nose wheel	75	- 780	- 58,500
Left main wheel	108	+ 475	+ 51,300
Right main wheel	108	+ 475	+ 51,300
Column totals:	291	Moment / Weight	44,100
<i>Empty Aircraft Arm</i>		151.55	mm aft of <i>Datum</i>

Empty Weight Trim Index: [(291 x 151.55) / 1000] = **44.1**.

Rebalancing the aircraft

You must now use the *Load and Balance Worksheets* in Section 6 of the Owners Manual to test all of the likely loading scenarios for your intended operations and see if any fall outside of the envelope.

For factory built aircraft we are required to use the CASA-approved standard passenger weight (currently 86kg) to calculate loadings, but as you are the builder you may choose to use the actual weights of yourself and your regular passenger(s) along with items that you intend to carry with you, such as tie downs, toolkit, suitcases, camping equipment and so on.

If it seems possible that an intended loading could exceed, for example, the forward limit, then you would need to consider adding some ballast to the rear of the aircraft.

If any rear ballast is required the preferred method is to add it in the form of lead shot mixed with resin to the ventral fin. (Note: It is unusual to need forward ballast – if there is an intended loading that would require forward ballast it will usually be very close to MTOW anyway and should very probably be avoided all together.)

Assuming that rear ballast is required you would measure the arm of the ballast station/ location from the *Datum* and calculate the weight of ballast required, adjust the calculations to obtain a revised *Empty Aircraft Weight*, *Empty Aircraft Arm* and *Empty Weight Trim Index* and then retest all of the likely loading scenarios for your intended operations and see if any still fall outside of the envelope.

Once you are satisfied that the majority of the likely loading scenarios for your intended operations will fall inside of the envelope, you may physically add the ballast and repeat the weighing procedure and then record the revised values in the *Aircraft Empty Weight Record* in Section 6.2 of the Owners Manual.

This completes the *Testing > Weight and balance* task.

Testing>Rigging check

Objectives of this task:

To perform a final check of all control surface deflections and make any adjustments that may be required prior to the first flight.

Each control surface has had its deflections set as part of the appropriate fitting task, so this final check is just to verify that nothing was missed during assembly.

Materials required:

Deflection templates for all control surfaces

Straightedge 1 metre long

Rudder

Check the rudder travel



Tape the rudder template over the rear of the empennage.

Place a saw stool under the front of the fuselage to lift the nose wheel off the ground and then adjust the rudder cable length so that the rudder sits on the centre mark with the rudder pedals centred and all level.

Use the rudder pedal adjustment set screws (shown arrowed at right) if required to adjust the rudder travel so that the rudder deflects to each full travel mark as shown in the photos above and mark each with *TorqueSeal*.

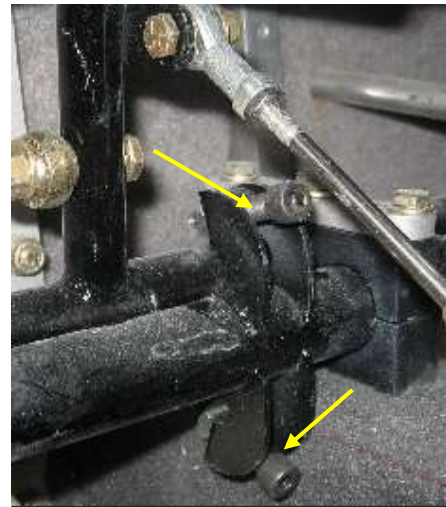

Rudder pedal adjustment detail

Flaps

Hold a straightedge under the wing and flap with a gap equal to 2 mixing sticks at the rear of the wing and touching at the front and back, all as shown in the photo below. Adjust the flap pushrods if required until all 3 positions are touching on each wing. Tighten the pushrod locknuts and mark each with *TorqueSeal*.



Ailerons

Check the control stick with the ailerons in the neutral position



Set the ailerons to the neutral position: a straightedge held under the wing must touch the front and back of the wing and the back of the aileron as shown arrowed in the photo above.

The control stick should be centred left to right at this position.

Adjust the aileron cable lengths as required to centre the control stick.

Check that all rod end jam nuts are tight and mark each with *TorqueSeal*.

Check the aileron deflections



Place the aileron deflection template on top of the wing and set the aileron to the full UP travel deflection as shown in the photo above (note the 3 arrowed points where the template touches) and then check and adjust the stop bolt on the aileron bellcrank so that the bolt just touches the eccentric stop at full deflection.

The eccentric stop that you fitted in the *Post-Paint>Fuselage>Interior>Fit console controls* task can be rotated if required to give an equal length to the stop bolts.

Repeat the process for the other aileron, tighten the stop bolt locknuts and mark each with *TorqueSeal*.

Elevator

Check the elevator travel

Use the supplied deflection templates to check the up and down travel of the elevator.



Hold the control stick all the way forward (have someone help you) and check the amount of down deflection and adjust the cable length (by screwing the rod ends in or out an equal amount at each end of the cable) until the down deflection is correct.



Now have your helper hold full back stick and check the amount of up deflection: it should be very close to correct if the down deflection is OK, however you may need to make some fine adjustments to equalise elevator travel until both up and down deflections are correct.

The elevator must clear the rudder and the down stop by 2mm at full deflection.

Recheck the up and down deflections and then lock the rod end lock nuts at each end of the cable and mark each rod end lock nut with *TorqueSeal*.

This completes the *Testing>Rigging check* task.



Testing > Calibrate fuel gauges

Objectives of this task:

To calibrate the fuel gauges so that they show the amount of fuel remaining correctly and to mark a fuel dipstick at the same time.

In this task you will be working with flammable fuel and you should take precautions such as having a suitable fuel extinguisher close to hand and no naked lights of any kind nearby.

In the task *Post-Paint > Wings > Prepare wings for fitting* you set the empty indication of the fuel gauges, now you must check the other indications: $\frac{1}{4}$, $\frac{1}{2}$, $\frac{3}{4}$ and full.

To do this you must have the following:

- A fuel supply of at least 135 litres of clean aviation fuel (AVGAS)
- An accurate means of measuring the fuel as it is dispensed
- Clean, sealable fuel container(s) capable of holding around 135 litres
- 2 metres of fuel grade tubing and a 1 litre container
- A length of clean wood or aluminium about 300mm long to use as a fuel dipstick

Some aircraft refuellers may allow you to use a part of their ramp area for this test provided that you purchase your fuel from them. The calibration process should take less than an hour.

Level the aircraft

Park the aircraft on the level surface and chock the main wheels.

Use a spirit level to check the aircraft for level: laterally level across the bottom of door sills; longitudinally level along the door sills. Pack under the wheels if and as required to level the aircraft. If the surface is exactly level you can measure the distance from each wingtip to the ground as a final check of lateral level, but the spirit level is the best reference.

The rest of this task depends on the aircraft remaining level throughout, so chock it carefully.

Find the zero fuel level

Remove the upper engine cowling.

Disconnect the fuel line in the engine bay at the firewall fitting and run a length of fuel line from the firewall fitting, down and out of the lower cowling and into a clean fuel container.

Turn the fuel tap on the console to the ON position, with the lever facing forwards.

Remove both fuel caps and pour a small amount of fuel into each wing tank. Allow the fuel levels to settle until some fuel runs out into the container. When the fuel no longer runs out of the line the header tank will be full and the wing tanks empty: this is your zero fuel level.

Lock off the fuel lines

Now that you are at the zero fuel level the fuel lines from each wing tank must be locked off by clamping both the front and back fuel pickup lines. Remove the lock wire around the fuel sheathing at the rear of the wing root to expose the fuel lines as they enter the cabin.

Clamping of the fuel lines must be done carefully so as not to stress the fuel line, so use a rounded surface with no sharp edges to bear against the fuel lines and apply just enough clamp pressure to close the line, no more. Medium size spring clamps will exert enough pressure to clamp the lines shut.



Calibrate the fuel gauges

Fit the fuel gauge calibration decal around each wing tank gauge opening in the wing root with the Zero indication on the decal placed against the fuel gauge needle – at this point there is no usable fuel in either wing tank.

The process now is to add 10 litres of fuel at a time to each tank in turn and mark carefully what each gauge needle indicates on each decal (use a pencil initially), and at the same time dip your fuel dipstick into each tank and mark carefully where the fuel level is on the dipstick.

If you have installed an engine management EFIS please refer to the documentation supplied with the unit for details of how to calibrate the equipment during this task.

If any fuel runs out of the temporary line from the firewall it indicates that there is not enough clamping pressure on a fuel line, so check carefully for any dribbling when the first fuel is added to each wing tank and make sure that it is corrected before proceeding.

Continue adding fuel in 10 litre increments until each tank is full, noting at each stage the gauge needle position for each tank each and marking the appropriate end and side of the fuel dipstick. Each wing tank will hold approximately 60 litres of fuel.

Once both tanks are full and each decal and each end of the dipstick have all been marked, remove the clamps from the fuel lines and check **very carefully** for any sign of weeping or leaking from the part of the fuel lines where the clamps were applied.

Any sign of a leak will require that the fuel be drained from both tanks (otherwise it will cross feed from the full tank to the empty tank) and complete replacement of the leaking fuel line.

Note that fracturing of the fuel lines after clamping is a rare occurrence that is only likely to happen if the fuel lines are very old, for example in a long-delayed build that has sat for many years. If this is the case we strongly recommend that **all** fuel lines be replaced before flight – if one fuel line is weak then the others are very probably in a similar state.

Even if your fuel lines are new you **must** check each line carefully for leaks after clamping.

Once all of the fuel lines have been checked and there are no leaks the protective sheathing can be refitted and lock wired back into place.

Flush all of the quick drains thoroughly – drain at least 500ml of fuel out of each one, more if there is any sign of dirt or debris: flush until the fuel runs clean from each drain.

Now you must drain all but 20 litres from each wing tank in preparation for test flying: use the temporary line from the firewall fitting and let both tank drain down to the 20 litre mark – you can use your new calibrated fuel dipstick to check the fuel level.

If you are using ramp space at the refuellers you may wish to push the aircraft back out of the way for the draining process, which can take some time. You may use the electric fuel pump to speed the draining process up. Record the time taken to fill a 1-litre container both with and without the use of the electric fuel pump and save the result for the *Final inspection checklist*.

Once the draining process is complete, reattach the fuel line from the carburettor to the firewall fitting and tighten the hose clamp and then refit and lock wire the fireproof sheath.

Mark the fuel gauge decals in a permanent manner. Keep your calibrated fuel dipstick in a handy location such as a door pocket and consider making a spare copy, just in case.

This completes the *Testing > Calibrate fuel gauges* task.

Testing>Registration markings

Objectives of this task:

To fit complying registration markings to the aircraft.

You will need to determine the requirements of the aviation authority in your own country.

In Australia either the Recreational Aircraft Association (RAA) for recreational registration or the Civil Aviation Safety Authority (CASA) for general aviation registration controls the allocation of aviation registration markings.

Registration markings should be made from vinyl by a specialist sign-writing company and applied by them, usually under the left wing and on each side of the empennage.

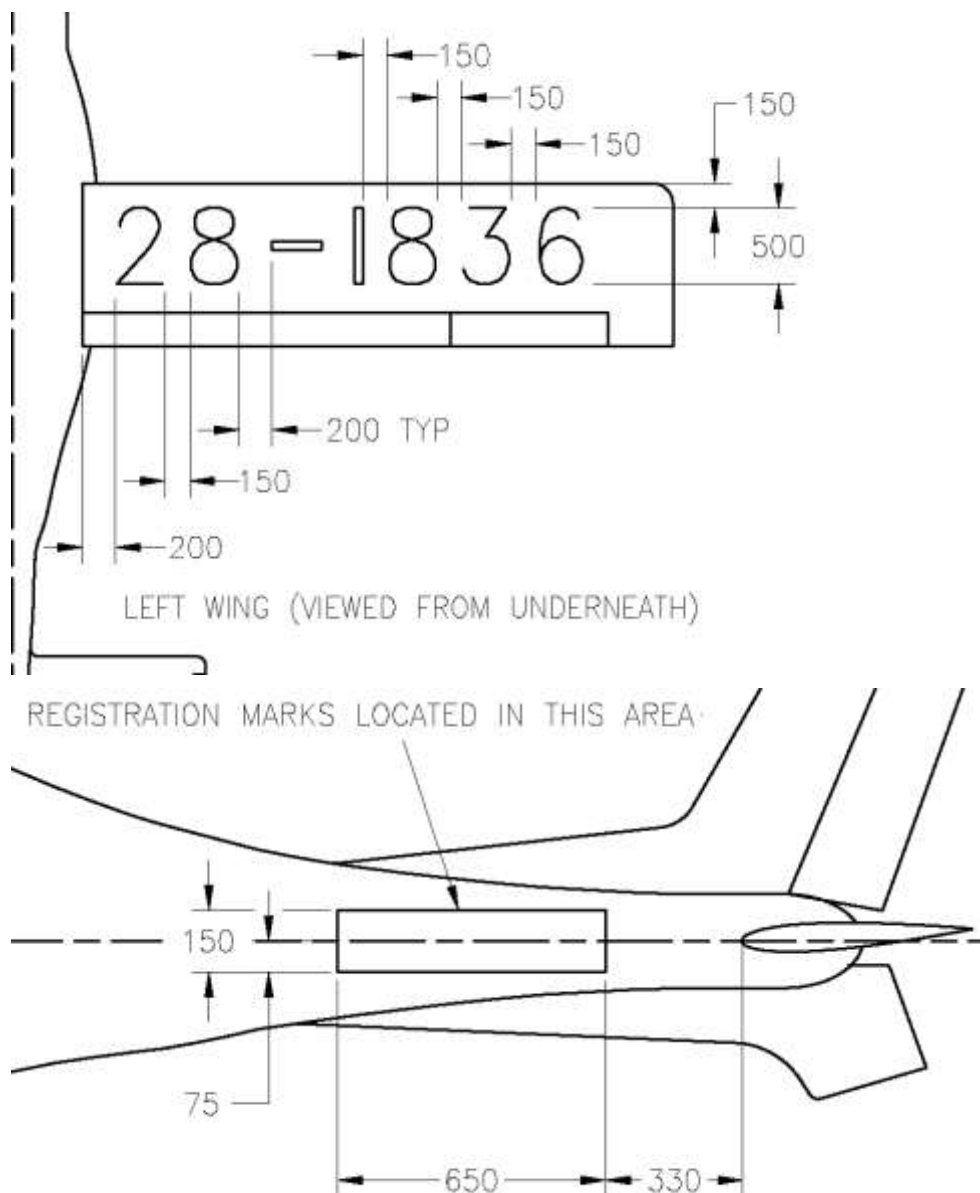

The drawings above show the RAA requirements as an example.

This completes the *Testing>Registration markings* task.



Testing>Final inspection checklist

This is the checklist that we use in the factory: it covers every part of the aircraft and it **must** be completed before your first flight.

Time to complete properly: at least one full day, probably more. Do **not** rush these checks!

Aircraft Registration: _____

Jabiru Model: _____

Firewall forward components

Propeller: Jabiru / Sensenich

Propeller Size:

Propeller Serial No:

Propeller Bolts

- 1 Check torque (Jabiru prop 7 ft/lbs, Senenich prop 12ft/lbs)
- 2 Check tip tracking is accurate to < 2mm, adjust if required
- 3 TorqueSeal the propeller nuts
- 4 Visually check propeller for serviceability

Spinner

- 1 Spinner screws secure
- 2 Check that the spinner and spinner backing plate has been indexed correctly and marked on the spinner and spinner flange
- 3 Visually check spinner tracking with the engine running

Engine

- 1 Engine Serial Number: _____
- 2 Engine mount bolts secure:
 - a) firewall
 - b) engine
- 3 Thrust washers in place and correct
- 4 Fuel hose secure:
 - a) bulkhead to fuel pump
 - b) fuel pump to carburettor
 - c) fuel lines all clamped and tied
 - d) fire sleeve covering clamps and lock wired in place
- 5 Breather hose from fuel pump: drain line routed correctly
- 6 Drip tray under fuel pump: drain line routed correctly



Spark Plugs/Coil leads

- 1 Spark plugs are secure in cylinder heads
- 2 Spark plug leads are secure on spark plugs
- 3 Spark plug leads not rubbing (on air ducts, cylinder heads)
- 4 Terminal nuts are secure
- 5 CHT sender (12mm terminal) secure
- 6 Spark plug leads secure in distributor caps
- 7 16 gauge earth wire secure and clipped to each coil

Ram Air Ducts

- 1 Baffles in place
- 2 Cap screws secure through ducts to cylinder heads
- 3 Springs in place inboard side of ducts
- 4 Spring lock-wire correct and secure
- 5 Check alignment of rubber front lip with the top cowl
- 6 Air ducts not touching the underside of the top cowl or oil door hinge
- 7 Cooling tubes directed onto coils

Engine Oil

- 1 Oil level correct (capacity: 2200 = 2.3 litres, 3300 = 3.5 litres)
- 2 Sump plug tightened and lock wired
- 3 Oil filter secure (spin on filter, hand pressure only)
- 4 Oil cooler bracket secured to engine
- 5 Oil cooler secured to bracket
- 6 Oil cooler hose clamps secure x 4
- 7 Check oil hose routing
- 8 Fire sleeve secure and lock wired over hose clamps
- 9 Oil breather hose and oil bottle secure

Throttle cable

- 1 Cable lock nuts secure on both ends of cable
- 2 Cable end free in carburettor link
- 3 Split pins secure
- 4 2 x 5/16 washers between cable and carburettor link
- 5 Cable alignment correct with outer at both ends
- 6 Cable adjustment
 - a) full throttle
 - b) idle



Choke Cable

- 1 Lock nuts secure both ends of cable
- 2 Cable end free in carburettor link
- 3 Split pin secure
- 4 Cable alignment correct with outer
- 5 Operational

Carburettor Heat Cable

- 1 Lock nuts secure both ends
- 2 Cable end free in carburettor link
- 3 Split pin secure
- 4 Cable alignment correct with outer
- 5 Operational

Cabin Heat Cable

- 1 Lock nuts secure both ends
- 2 Butterfly sealing in ON and OFF positions
- 3 Over-centre spring fitted properly and working
- 4 SCAT hoses routing – nothing rubbing, etc

Scat Hoses

- 1 Hot air mixer box to carburettor
 - a) hose clamps secure
 - b) hose not bunched up under carburettor
 - c) cobra head fitted and aligned properly
 - d) smooth routing
- 2 NACA duct in cowl to hot air mixer box cold air inlet
 - a) hose clamps secure
 - b) smooth routing and secure
- 3 Heat shroud on muffler to hot air mixer box hot air inlet
 - a) hose clamps secure
 - b) smooth routing



Nose leg and housing

- 1 Front tyre pressure checked: 34 psi
- 2 [Tyre Pressure] decal in place on spat above grommet
- 3 Nose wheel - ease of rotation
- 4 Nose leg – lubricated and ease of rotation left to right
- 5 Assembly – all bolts secure in nose leg
- 6 Housing bolts secure
- 7 Rod ends secure both sides
- 8 Safety hole in rod ends within limits
- 9 Jam nuts on rod ends secure
- 10 Air valve grommet in place
- 11 Spat retaining screws secure
- 12 Centring springs do not become coil bound full deflection

Electrical

- 1 Battery tie down secure
- 2 Battery terminals secure
- 3 Battery earth secure on firewall
- 4 Starter solenoid locknuts and wires secure
- 5 Regulator wires secure and correct
- 6 Temp sender wires secure (EOT and CHT) plus EGT if fitted
- 7 All wiring cable tied and secure
- 8 Oil pressure wire correct and secure (G terminal)

Cowls

- 1 Top and bottom cowl alignment correct (no gaps)
- 2 Retained nuts secure and correct
- 3 Oil door operational
- 4 Spinner not touching front of cowl and Propeller
- 5 Oil cooler not touching bottom cowling
- 6 Cylinder heads not touching top or bottom cowling
- 7 NACA duct secure with no sharp edges
- 8 Cam locks secure and operational



Interior

Fuel system

- 1 Fuel filter secure and flow direction correct
- 2 Fuel pump (electronic) secure and flow direction correct
- 3 Fuel lines secure:
 - a) fuel pickups and breather lines from wing roots to header tank inlets
 - b) header tank outlet to fuel filter
 - c) fuel filter to electric fuel pump
 - d) electric fuel pump to fuel tap on console
 - e) fuel tap on console to bulkhead fitting
- 4 Fuel line sheathing in place and secure
- 5 Check fuel valve mounting and lever secure to console
- 6 Fuel Breather:
 - a) check breather hose clamps and breather route
 - b) wing breather tube to wing root secure
 - c) check ball in breather in wing tank cap is free
 - d) check fuel breather tube is secure to body fuel filler
 - e) fuel breather check has been conducted:
 - Note: you must be able to hear air in all outlets independently by:
 - i) Removing filler cap in left wing and blow into tank
 - ii) Removing filler cap in right wing and blow into tank

Fuel gauges

LEFT RIGHT

- 1 Window fitted in fuselage opposite wing roots
- 2 Calibration decal in place left and right
- 3 Wires connected to left and right senders
- 4 Left sender drives left gauge and vice versa
- 5 No leaks from sender boss

Fuel flow test

- 1 20 litres of fuel in each wing tank
- 2 Check fuel tap has been correctly indexed i.e. ON is on OFF is off
- 3 Select fuel tap on and measure the fuel flow (recorded in *Calibrate fuel gauges* task)
 - a) electric fuel pump OFF _____ litres per minute
 - b) electric fuel pump ON _____ litres per minute

There should be around 1 litre per minute flow with the electric fuel pump ON



Controls

Rudder pedals

- 1 Rudder springs installed properly
- 2 Rudder stops lining up properly
- 3 2 x Pedal mount bolts secure (pushrod to pedals)
- 4 Rudder pedal keepers secure and correct
- 5 2 x 1/4" and 4 x 3/16" bolts secure in bearing blocks
- 6 2 x 1/4" bolts secure in pushrods (pushrod to nose leg yoke)
- 7 Check jam nuts on rod ends secure x 5
- 8 Check safety hole is within limits on rod ends x 5
- 9 Check rod end free play at full deflection, both directions
- 10 Rudder clear of fin channel. Rudder cannot bind on channel

Rudder cable

- 1 Anchor secure and correct position in clamp
- 2 Rod end secure in pedal with 1/4" washer outside
- 3 Safety hole is within limits on rod ends
- 4 Jam nuts on rod ends secured
- 5 Rod end free play at full deflections, in both directions
- 6 Rudder pedal stops adjusted and secure:
rudder should move 78mm left and right from the 5mm offset centre mark

Trim

- 1 Trim levers (left and right) are secure
- 2 Lever pivot secure and split pin fitted through nut
- 3 Free play between left and right side levers not excessive
- 4 Friction correct and secure
- 5 Rod end secure
- 6 Safety hole is within limits on rod ends
- 7 Jam nuts on rod ends secured
- 8 Cable position in clamp correct and anchor secure
- 9 Operation full forward and full back trim
- 10 Spring not coil bound with elevator fully deflected up
- 11 Placard fitted to console top in correct sense



Brake

- 1 Handle assembly correct and secure
- 2 Check safety hole within limits
- 3 Operation
- 4 Free play
- 5 Fluid level full
- 6 Stainless striker in place
- 7 Handbrake correct and operational

Throttle

- 1 Cable anchor secure
- 2 Cable alignment correct
- 3 Cable end free in output lever
- 4 Output lever secure
- 5 Input lever x 2 secure
- 6 Throttle lock hole in pilot's input lever
- 7 Bearing blocks x 2 secure
- 8 Throttle stops correct and secure

Main control shaft

- 1 Control stick pivot secure
- 2 Yoke secure (no free play)
- 3 Rod end secure
- 4 Safety hole is within limits on rod ends
- 5 Jam nuts on rod ends secured
- 6 Elevator cable anchor secure and correct position in clamp
- 7 Elevator cable clear of centre console in all positions
(particularly elevator UP and aileron to left hand side)
- 8 Rod end free at full deflections
- 9 Aileron bell crank lines up properly with stops and is not binding



Aileron Cable

	LEFT	RIGHT
1 Cable anchor wedges in place	<input type="checkbox"/>	<input type="checkbox"/>
2 "R" clips in place	<input type="checkbox"/>	<input type="checkbox"/>
3 Rivets x 3 TLR through each bracket and seat back	<input type="checkbox"/>	<input type="checkbox"/>
4 Rod end secure	<input type="checkbox"/>	<input type="checkbox"/>
5 Safety hole is within limits on rod ends	<input type="checkbox"/>	<input type="checkbox"/>
6 Jam nuts on rod ends secured	<input type="checkbox"/>	<input type="checkbox"/>
7 Aileron stoppers secure x 2 (cannot over centre aileron bellcrank)		<input type="checkbox"/>

Seat belts

	LEFT	RIGHT
1 Check bolts are through Nyloc and buckle has free play	<input type="checkbox"/>	<input type="checkbox"/>
2 Operation of buckle and length adjustments play	<input type="checkbox"/>	<input type="checkbox"/>
3 Belts not twisted play	<input type="checkbox"/>	<input type="checkbox"/>
4 Seat belt anchor secure (lower and upper) play	<input type="checkbox"/>	<input type="checkbox"/>
5 Door frame compression struts in place, no sharp edges	<input type="checkbox"/>	<input type="checkbox"/>

Headsets

1 Hook secure		<input type="checkbox"/>
---------------	--	--------------------------



Instrument panel

- 1 Secure and level
- 2 Instruments square (check that the slip/skid ball is centred).
- 3 Slip/skid ball air bubble not visible
- 4 Circuit breakers secure and correctly labelled
- 5 Switches secure and correctly labelled
- 6 Registration number displayed on panel
- 7 Mag switch guard in place and square with rounded edges
- 8 All instruments fitted and operational *
- 9 Instrument markings correct
- 10 Altimeter QNH correct
- 11 All avionics installed and operational
- 12 Cigarette lighter / 12v power fitting installed

* Fit 1 metre of rolled up surgical tubing to the brass static tube connector under the panel.

Watch the pressure instruments while slowly unrolling the tubing. The altimeter should start to show an increase in altitude. The vertical speed indicator should start to show a positive rate of climb and the airspeed indicator may show a small positive indication.

When the altimeter shows 2000 feet pinch off the tubing. There will be some initial decrease in altitude and the vertical speed indicator will read zero. The altimeter should then hold the indicated altitude for at least one minute. If altitude is lost then look for leaks.

Note: NEVER apply suction orally or mechanically to a static line - it can damage the instruments.

Flaps

- 1 Mounting bolts secure
- 2 Rod end bolt secure: motor end and flap shaft ends
- 3 Rod end not binding in any position
- 4 Safety hole is within limits on rod end
- 5 Jam nut on rod end secured
- 6 Visual on input switch (knob shape, operation and decal)
- 7 Visual on bearing blocks
- 8 Check all nuts are in safety

Flap indicator

- 1 Secure and correct indication:
 - a) Flaps up
 - b) First stage: half flap
 - c) Second stage: full flap



Upholstery:

- | | |
|------------------------------|--------------------------|
| 1 Fitted and clean | <input type="checkbox"/> |
| 2 Seat covers | <input type="checkbox"/> |
| 3 Map pockets | <input type="checkbox"/> |
| 4 Flap shaft upholstered | <input type="checkbox"/> |
| 5 Centre console upholstered | <input type="checkbox"/> |
| 6 Fuel line covers in place | <input type="checkbox"/> |

Placards and decals:

- | | |
|--|--------------------------|
| 1 [No Smoking] on panel | <input type="checkbox"/> |
| 2 [No Intentional Spins] on panel | <input type="checkbox"/> |
| 3 [Voltage must be displayed at all times] above EMS (if applicable) | <input type="checkbox"/> |
| 4 [Transponder not calibrated] (if applicable) | <input type="checkbox"/> |
| 5 Switches labelled (label above switch, [OFF] below switch) | <input type="checkbox"/> |
| 6 [Aircraft built to LSA standards] decal beside main placard | <input type="checkbox"/> |
| 7 Warning placard above windscreen. Weight entered | <input type="checkbox"/> |
| 8 Baggage (Limit, loading rules, seat backs) | <input type="checkbox"/> |
| 9 Loading stations | <input type="checkbox"/> |

Doors:

- | | LEFT | RIGHT |
|---|--------------------------|--------------------------|
| 1 Operation: open and shut, latches working | <input type="checkbox"/> | <input type="checkbox"/> |
| 2 Restraining straps secure and correct length | <input type="checkbox"/> | <input type="checkbox"/> |
| 3 Hinge and pin secure | <input type="checkbox"/> | <input type="checkbox"/> |
| 4 Catches secure and freely operating (main plus top latch) | <input type="checkbox"/> | <input type="checkbox"/> |
| 5 Visual on door jamb | <input type="checkbox"/> | <input type="checkbox"/> |
| 6 Visual on door seal | <input type="checkbox"/> | <input type="checkbox"/> |
| 7 Visual on handle | <input type="checkbox"/> | <input type="checkbox"/> |
| 8 Visual on top catch | <input type="checkbox"/> | <input type="checkbox"/> |
| 9 Decals | | |
| a) [Do Not Lean On Door] | <input type="checkbox"/> | <input type="checkbox"/> |
| b) [Exit] | <input type="checkbox"/> | <input type="checkbox"/> |
| c) [Open] | <input type="checkbox"/> | <input type="checkbox"/> |



Exterior

Wings:

	LEFT	RIGHT
1 Root bolts inspected (correct tension) x 2	<input type="checkbox"/>	<input type="checkbox"/>
2 Strut bolts x 2 inspected, correct tension	<input type="checkbox"/>	<input type="checkbox"/>
3 Warning decals in wing roots x 2 [Do Not Tighten]	<input type="checkbox"/>	<input type="checkbox"/>
4 Wing root cover strips secure	<input type="checkbox"/>	<input type="checkbox"/>
5 Upper strut fairing secure and clear of strut	<input type="checkbox"/>	<input type="checkbox"/>
6 Lower wing strut/belly fairings secure	<input type="checkbox"/>	<input type="checkbox"/>

Flaps

1 Hinge points secure with pivot bolts in safety	<input type="checkbox"/>	<input type="checkbox"/>
2 Pushrod rod ends secure and not binding in any position	<input type="checkbox"/>	<input type="checkbox"/>
3 Safety hole in rod ends is within limits	<input type="checkbox"/>	<input type="checkbox"/>
4 Jam nuts on rod ends secure	<input type="checkbox"/>	<input type="checkbox"/>
5 Pushrods not fouling on cover strips	<input type="checkbox"/>	<input type="checkbox"/>
6 Drive shaft output secure	<input type="checkbox"/>	<input type="checkbox"/>
7 Drain holes have been drilled	<input type="checkbox"/>	<input type="checkbox"/>
8 Flap operation:		
a) flaps up	<input type="checkbox"/>	<input type="checkbox"/>
b) first stage – half flap	<input type="checkbox"/>	<input type="checkbox"/>
c) second stage – full flap, not fouling fuselage	<input type="checkbox"/>	<input type="checkbox"/>
9 Flap slot gap even, smooth and the same size on both wings	<input type="checkbox"/>	<input type="checkbox"/>

Fuel caps

1 Filler caps secure in fuel filler body	<input type="checkbox"/>	<input type="checkbox"/>
2 Earth wires secure from caps to breather fitting in tank	<input type="checkbox"/>	<input type="checkbox"/>
3 Quick drain: operation and lock wired	<input type="checkbox"/>	<input type="checkbox"/>
4 Decals in place and correct	<input type="checkbox"/>	<input type="checkbox"/>



Ailerons	LEFT	RIGHT
1 Deflections		
a) Neutral (level with lower wing skin) with stick centred	<input type="checkbox"/>	<input type="checkbox"/>
b) UP _____degrees, or touches template	<input type="checkbox"/>	<input type="checkbox"/>
c) DOWN _____degrees	<input type="checkbox"/>	<input type="checkbox"/>
2 Hinge pins and pin retainers secure	<input type="checkbox"/>	<input type="checkbox"/>
3 Rod ends secure	<input type="checkbox"/>	<input type="checkbox"/>
4 Safety hole on rod ends within limits	<input type="checkbox"/>	<input type="checkbox"/>
5 Jam nuts on rod ends secure	<input type="checkbox"/>	<input type="checkbox"/>
6 Cable anchor secure and correct position in clamp	<input type="checkbox"/>	<input type="checkbox"/>
7 Drain holes		
a) Wing drain hole in trailing edge	<input type="checkbox"/>	<input type="checkbox"/>
b) Aileron cable inspection windows secure	<input type="checkbox"/>	<input type="checkbox"/>

Pitot

- 1 Secure
- 2 ASI operation (see * below)
- 3 Cover present
- 4 Pressure Test with no leaks (see * below)

* Slip 1 metre of surgical tubing over the pitot tube. Have one person watch the airspeed indicator while the other person very slowly rolls up the tubing. This will apply pressure to the instrument in a gentle and controllable manner. When the ASI needle reaches cruising speed pinch the tube shut – the ASI should hold that reading for at least one minute. A fast drop off will indicate a leak in the instrument, fitting, lines or the test hose attachment.

Note: NEVER blow into a pitot tube – it can damage the ASI.

Stall warning:

- 1 Stall warning horn secured in cabin
- 2 Operation correct (suck to ensure reed is working)
- 3 Gauze and lip installed correctly and clear



Main Undercarriage	LEFT	RIGHT
1 Main gear legs secure	<input type="checkbox"/>	<input type="checkbox"/>
2 Stub axle secure	<input type="checkbox"/>	<input type="checkbox"/>
3 Hubs secure	<input type="checkbox"/>	<input type="checkbox"/>
4 Stub axle extension is secure	<input type="checkbox"/>	<input type="checkbox"/>
5 Calliper secure	<input type="checkbox"/>	<input type="checkbox"/>
6 Discs secure	<input type="checkbox"/>	<input type="checkbox"/>
7 Ease of rotation	<input type="checkbox"/>	<input type="checkbox"/>
8 Tyre pressure 45 psi	<input type="checkbox"/>	<input type="checkbox"/>
9 [Tyre Pressure] decal in place	<input type="checkbox"/>	<input type="checkbox"/>
10 Brake line not rubbing on spat	<input type="checkbox"/>	<input type="checkbox"/>
11 Spats		
a) screws secure	<input type="checkbox"/>	<input type="checkbox"/>
b) clear of tyre	<input type="checkbox"/>	<input type="checkbox"/>
c) retain nuts	<input type="checkbox"/>	<input type="checkbox"/>
d) outer edge – nothing rubs	<input type="checkbox"/>	<input type="checkbox"/>
e) air valve grommet in place	<input type="checkbox"/>	<input type="checkbox"/>
f) [No Step] decal in place	<input type="checkbox"/>	<input type="checkbox"/>



Empennage

Elevator Deflections

- 1 UP _____ degrees, or touches the UP template
- 2 DOWN _____ degrees, or touches the DOWN template
- 3 2mm clearance to the stop on fuselage at full DOWN deflection

Elevator

- 1 Hinge pins and retainers secure
- 2 Rod ends secure
- 3 Safety in rod ends within limits
- 4 Jam nuts on rod ends secure
- 5 Cable anchor secure and correct position in clamp
- 6 Drive plate secure
- 7 Rod end free play at full deflections
- 8 End-plug not touching end-cap full deflection down
- 9 Elevator min 2mm clear of stabiliser channel
- 10 Elevator cannot bind on horizontal stabiliser channel

Trim

- 1 Pivots secure
- 2 Spring rod
 - a) split pins secure
 - b) springs lubricated
 - c) black block secure and free
 - d) rod ends secure
 - e) safety hole within limit
 - f) jam nuts secure
 - g) rod end free at full deflections
- 3 Trim cable
 - a) cable anchor secure and correct position in clamp
 - b) rod ends secure
 - c) safety hole in rod ends within limits
 - d) jam nuts on rod ends secure
 - e) rod end free at full deflections



Ventral Fin:

- 1 Retained nuts in fuselage secure
- 2 Elevator horn not hitting cut-out in ventral fin at full up deflection
- 3 Inspection holes drilled
- 4 Drain holes drilled out
- 5 Ventral fin secure onto fuselage

Rudder:

- 1 Centre 5mm offset to right when pedals level
- 2 Deflection
 - a) Left _____mm from the offset centre mark
 - b) Right _____mm from the offset centre mark
- 3 2mm clearance to the stops on fuselage at full deflection
- 4 Hinge pin and pin retainers secure
- 5 Rod end secure
- 6 Safety in rod end within limits
- 7 Jam nut on rod end secure
- 8 Cable anchor secure and correct position in clamp
- 9 Rod end free at full deflections

Static Vent:

- 1 Tip secure
- 2 Holes clear
- 3 Decal in place

Note that leak testing of the static system has been performed as part of the instrument checklist.

I hereby certify that I have completed this Final Inspection Checklist:

Owner / Builder / Engineer (strike out any that do not apply)

Date



Testing>Flight testing

Objectives of this task:

To safely and successfully test fly the aircraft, record information resulting from the flight test sequence and use that information to fine tune the flying characteristics of the aircraft.

Well, this is what it all comes down to: you have built your own Jabiru, you have painted it and assembled it and checked and tested every part of it to your satisfaction and now it is time to finish the project and actually fly the machine for the first time!

This is no small undertaking, and you must ask yourself if you are capable of performing the flight test on your own, or, perhaps, if your experience level or recency is low, you may wish to hire a more experienced pilot to conduct some or all of the flight testing for you.

This task will step you through each of the flight testing stages that we employ here in our factory testing program, along with the appropriate forms to record the results of each stage.

The correct sequence for rectifying any out of rig conditions will be explained along the way.

Reference documentation

The Australian Civil Aviation Safety Authority (CASA) produces a “Flight Test Guide for Certification of CAO 101.28 Category Airplanes”. This document is required to be completed as part of the approval process for Australian-built aircraft.

In countries other than Australia, the amateur builder should seek advice from the appropriate Airworthiness Authority and/or the relevant amateur building association (EAA Chapter or equivalent) as regards their requirements.

In the USA the FAA publishes the “Amateur-Built Aircraft and Ultralight Flight Testing Handbook” (publication AC90-89A), which addresses the topic in considerable detail and which may be obtained here: www.faa.gov/library/manuals/

Sequence

This task will address the following steps:

- Preliminary work
 - Airport selection
 - Emergency plans and equipment
 - The test pilot
- Sequence #1: Ground runs
 - Engine parameters
 - Taxi testing
- Sequence #2: Initial flight and function testing
 - First flight, rigging checks
 - Rigging corrections
- Sequence #3: Performance flight testing



Airfield selection

Airfield selection will play a very important role in your testing and you should approach your choice of airfield with considerable care. The nearest flat piece of land may not necessarily be the best or safest place and you may have to consider transporting your new Jabiru by road to a suitable airfield for the flight testing sequence.

The ideal airfield would be at or near sea level with a runway of at least 1000 metres length (for every 1000 feet increase in elevation add 200 metres to the length required) in an area that is relatively flat with few obstructions near the airfield. Ideally there should not be many buildings surrounding the airfield and there should be enough open space around the airfield to allow for the possibility of an out landing.

The test pilot should familiarise himself with the surrounding area from the air with particular regard to suitable landing areas for emergency use before starting the testing sequence.

Emergency plans and equipment

Before any testing can begin you must have a plan in place to deal with emergency situations. You must address what actions to take if it all goes badly and an accident happens and know the local emergency telephone numbers.

A support crew of 2 suitably experienced people will be required to support the flight testing sequences and assist the test pilot with refuelling and checking the aircraft.

The following details the bare minimum requirements, to which you may wish to add your own items:

The GROUND emergency plan

All crew (pilot and ground crew) should know how to:

- Open the cabin doors
- Release the pilots harness/seat belt
- Locate and turn off the fuel valve
- Locate and turn off the Master switch and the magneto switches
- Remove the cowling and disconnect the battery for fire fighting purposes

The IN-FLIGHT emergency plan

The pilot will need to consider his response to the following:

- Complete or partial engine failure, particularly shortly after takeoff
- Flight control problems including severe out of rig conditions
- Fire in the engine compartment or cockpit

Equipment

The pilot should carry a CO2 detector in the cockpit at all times during all flight testing.

The crew should have access to a dry powder fire extinguisher.

There should be 2-way radio communication between the pilot and the support crew at all times as well as any radio communication required by local regulations. Most Jabiru aircraft will have a VHF radio installed, and if the support crew have a hand-held VHF radio then a discreet frequency can be used to communicate during the test flight sequence.



The test pilot

Flight testing must only be carried out by a suitably qualified and experienced test pilot.

Test flying any newly built aircraft is risky. For example, minor changes to aircraft rigging can significantly alter stall behaviour, leading to extreme wing drops or spinning. Test pilots must be aware of this and all other potential risks and be suitably skilled to recover control of the aircraft from extreme and unusual attitudes.

The Test Sequence in this task is based on the Test Schedule used by Jabiru Aircraft on factory-built models and is supplied as reference material as a part of the construction data for this kit. Several of the manoeuvres required by this schedule will result in extreme aircraft attitudes and carry an increased risk of spinning or other undesirable aircraft behaviour.

Pilots choosing to follow the Jabiru Aircraft Test Sequence do so at their own risk.

Recency

In particular, the test pilot should have a recently demonstrated ability to:

- Deal with an engine failure at low altitude (~200ft) after takeoff
- Recover from stalls in level flight and in banked turns
- Recover from a spin
- Recover from unusual attitudes (including a spiral dive)
- Carry out a flapless landing
- Carry out a glide approach and landing

Medical considerations

The test pilot should be in good health and should abide by the following conditions:

- Should not have a head cold or any current sinus problems
- Have had no local or dental anaesthetics for at least 48 hours prior to test flying
- Alcohol: an absolute minimum of 24 hours, preferably longer, must have elapsed between the last consumption of alcohol and any test flying
- Should not have donated blood for at least 3 weeks prior to test flying

Clothing

The test pilot should consider the possibility of an in-flight fire and dress accordingly:

- Dress ONLY in natural fibres and do NOT wear any synthetic materials
- Long pants and long sleeves – no bare skin should be exposed
- Nomex gloves for hand protection (most pilot supplies shops carry these)

Checklists

The test pilot should be completely familiar with the normal and emergency checklists in the Owners Manual and should commit to memory the critical airspeeds that are specified in the Owners Manual.

It may be useful to write these speeds down and tape them to the instrument panel for ease of reference in flight.



Sequence #1 – First start, ground run and taxi

Print and use the Flight Testing form *Sequence #1* for this sequence.

Locate the aircraft on a suitable run-up area with no gravel or small stones in the area under the propeller, point the nose of the aircraft into wind and chock the main wheels.

Pre start

Remove the upper cowling and set it aside. Remove the spark plugs, turn the Master switch ON and leave both magneto switches OFF. Press the starter button and allow the engine to crank over. Watch the *Engine Oil Pressure* (EOP) gauge for the first indication of oil pressure. Stop cranking once oil pressure is seen. Refit the spark plugs and upper cowling.

Start

Turn both magneto switches ON and pull the choke ON. Turn the fuel tap ON, turn the fuel pump ON and listen for its operation for 10 seconds. Turn the fuel pump OFF.

Press the starter button; listen for the click of the solenoid, and the winding of the starter motor. The engine should start within a few revolutions, usually as soon as fuel reaches the carburettor. Listen for the sound of the starter motor disengaging after engine start.

Watch the EOP and if it does not rise in the first 10 seconds after starting shut the engine down and call the mechanic. The EOP range should be from 220 to 525 kPa.

Idle condition

The idle should be smooth and may be up to 1400 rpm with the choke on, and up to 900-950 rpm with the choke off. Note that the requirement for choke will vary with OAT. Check the *Engine Oil Temperature* (EOT), it should rise slowly and steadily to 50 – 60 °C, and the *Cylinder Head Temperature* (CHT) should rise to 85 – 105 °C. The *Exhaust Gas Temperature* (EGT) gauge (if fitted) should read between 425 – 485 °C.

Once the engine has warmed (EOT 50°C or more) then you may proceed, but before you do the idle speed must be adjusted correctly in accordance with the procedure in the next step.

Idle speed adjustment

Once the engine has been warmed to operating temperature then the idle speed must be adjusted before proceeding. This idle speed adjustment procedure will require 2 people: one inside the cabin operating the engine and one adjusting the idle stop on the carburettor.

Stop the engine by turning both Mag switches to the OFF position. If the engine will not stop it means that a Mag earth wire is not correctly connected – in this event stop the engine by turning the fuel tap OFF and waiting until the engine stops. Connect the earth wire before re-starting the engine.

Remove the upper cowling and set it aside. The Pilot side throttle input shaft has 2 alloy collars while the Co-Pilot side has 1 collar. Loosen all 3 collars with an Allen key, working through the holes in each side of the instrument panel housing. Start the engine and adjust the idle stop on the carburettor until the engine idles at 900 rpm. Stay well clear of the propeller!

Adjust the collars on the input shafts so that when the engine is at idle the collars on each input shaft are just touching the back of the input shaft pivot block. Lock each idle collar in place. With the engine turned OFF push both input shafts to full throttle and adjust the Pilot side collar so that it is just touching the other side of the pivot block and lock it in place.

Re-test the idle and make any further adjustments required. Replace the upper cowling.



Run up and full power check

Re-start the engine and smoothly increase the engine speed to 2000 rpm. Check that all temperatures and pressures are in the green part of the range.

Check each magneto individually: the maximum permissible rpm drop is 200 rpm but it is typically much less. If an rpm drop of more than 100 rpm occurs on either magneto, shut the engine down and call for the mechanic.

Still at 2000 rpm apply carburettor heat: the maximum permissible rpm drop is 100 rpm but it is typically much less. Check that all temperatures and pressures are still in the green.

Advance the throttle until it is fully open: the engine should not falter or surge during this operation. Record the maximum sustained static speed (2975 – 3050 rpm); wait for 60 seconds and then record the EOP, EOT, CHT and EGT (if fitted). Limit the full power segment of the ground run to less than 2 minutes total time.

Bring the engine smoothly back 1200 rpm for a minute or 2 and then back to idle.

Engine shutdown

Allow the engine to return to idle: the idle should be smooth at 900 rpm. Turn both magneto switches OFF and the engine should stop smoothly.

Turn the Master switch OFF.

Remove the cowling and check for any leaks of oil or fuel. Correct as required before proceeding with the testing sequence.

Taxi tests

Re-start the engine and taxi to the movement area or ramp with your headset off.

Listen for and note:

- Airframe sounds
- Electric fuel pump functioning
- Suspension movement
- Doors and windscreen structure movement
- Wheel bearings and brakes
- Tyres rubbing on the wheel spats (if fitted)
- Steering: should steer positively

Approaching the movement area or ramp cut the engine.

Check that the aircraft rolls freely without brake drag. At a slow speed and without your feet on the rudder pedals apply the brakes firmly, the brakes should pull straight and the aircraft should stop abruptly.

Any brake binding or wheel rubbing issues should be rectified before the first flight.

Restart the engine.

On the movement area or ramp check the turning circle (left and right turns). The radius of the left and right turns should be the same.

Face into and taxi into wind. The aircraft should track straight with feet off the rudder pedals.



Compass swing

While you are out in the run-up area and provided that the ground run has gone well, this would be a good time for a compass swing before you start the actual test flying.

You will need assistance to turn the aircraft accurately onto headings and your ground crew can help you with this. You'll need a small, brass, non-magnetic screwdriver and ideally an airport with a compass rose: a compass rose is a pattern painted on the ground, which accurately depicts magnetic headings. If your local airport doesn't have one you can make your own using the known magnetic orientation of the runways at an airport or a 'known good' hand held reference compass with an alignment sight.

Be careful with this approach though, just because a runway is marked "14" doesn't mean it is oriented at 140°, it might actually be oriented 144° or 138°. Check with your local airport operator to get the precise orientation. A hand held reference compass is usually preferable.

Remove all metal objects from your person and the aircraft before you start and make sure that the selected area has no nearby metal structures that could affect the magnetic compass.

For the test the aircraft should be configured as it would be for flight, with the engine running and all avionics and Nav and strobe lights turned on. Try some test transmissions with your VHF comms to see if transmissions affect the compass in any way.

Under the compass' display window are 2 screws that are used to compensate for instrument errors, one for North South adjustments and the other for East West adjustments.

Position the aircraft at a known North heading using a compass rose or a reference compass.

1. With the aircraft oriented North, the engine running, and all radios switched on, adjust the N-S adjusting screw until the compass reads due North, or 0°.
2. Rotate the aircraft to a known East heading, and use the E-W adjusting screw to make the compass read due East, or 90°.
3. Rotate the aircraft to a known South heading. Note how many degrees off South the compass reads. Turn the N-S adjusting screw to remove one half of the error.
4. Rotate the aircraft to a known West heading. Note how many degrees off West the compass reads. Adjust the E-W adjusting screw to remove one half of the error.
5. Rotate the aircraft through the N, E, S and W headings again, confirming that the errors for North and South are the same, and the errors for East and West are the same. You may want to repeat steps 1-4 to fine-tune the corrections.
6. Now rotate the aircraft from North, stopping at each 30° point on the compass rose or reference compass (e.g., 030, 060, 090, 120, 150, 180, 210, 240, 270, 300, and 330 degrees) and make a note of the actual aircraft compass reading compared to the compass rose or reference compass at each point, then complete the compass calibration card that was packed with your compass, which you should then mount in the holder on the front of the compass for reference.

If you cannot get a usable set of readings you will need to locate any sources of magnetic interference. Look for steel screws, washers or other components near the compass. You should also experiment with aircraft electrical systems (lights, for example), to see whether activation of that equipment causes the compass to misbehave.

The compass should be re-swung after any significant changes to the panel or engine bay and at least once every 2 years.



Sequence #2 – First flight and rigging tests

Pre-flight

Print and use the Flight Testing form *Sequence #2* for each test flight in this sequence.

Recording

Use a kneeboard or clipboard to hold the Flight Test forms and record details of each test flight, however the first priority must always be to *fly the aircraft* so write things down **only** when it is safe to do so.

Loading

Load the aircraft with the test pilot and 20 litres of fuel in each wing tank.

If you have followed the instructions in the *Testing > Calibrate fuel gauges* task you should already have 20 litres per side at this point, if not then drain or add fuel as required.

Engine Start and Run-up

Start the engine normally, taxi to the run-up area and perform an engine run-up.

Check temperatures and pressures and make sure that the idle is correct when the engine is warm – it should idle at around 900 rpm.

Pre-take off Checks

Record the date and engine hours as well as the wind direction and strength, the OAT, the Runway in use and the Pressure Altitude. Set the altimeter back to the local QNH.

Check controls for full and free movement and correct sense – see each control surface movement. Any sense of controls binding **must** be addressed before proceeding.

Listen for traffic and wait for the traffic to clear for first flight. Carry out the pre-takeoff checks specified in the Owners Manual.

Advise all traffic that a first flight is to be conducted.



Flight testing

Takeoff and climb

Use the full length of the available runway, which should be into wind.

Apply full power in a positive manner over a count of 4.

Check engine rpm indication and ASI function on the roll and abort if either is incorrect.

Immediately after takeoff check instruments and LISTEN, FEEL and SMELL and if in any doubt abort and land on the remaining runway, otherwise proceed.

Climb at full power at 80 KIAS while remaining over the airfield: remain within gliding distance of the airfield at all times on the first flight: plan your climb carefully so that you are always within reach of the field should the engine fail. This may require an initial turn at less than 500 ft AGL depending on the layout of the airfield.

Monitor the engine gauges carefully while climbing and note any tendency towards overheating. If temperatures get near to the top of the green range, increase airspeed to 90 KIAS to improve the cooling airflow. If the temperatures are still too high, reduce power slightly. Be particularly alert when you reduce the power for the first time.

At 3,000 ft above the airfield reduce the power to 2800 rpm, trim the aircraft for straight and level flight and check the rigging of the aircraft.

Rigging tests

If the aircraft flies straight with the ball in the centre and the rudder pedals are level the rigging is correct. There are 4 steps or tests that must be made:

1. If the aircraft flies straight with the ball in the centre but with the rudder pedals displaced then the pushrods that connect the rudder pedals to the steering yoke need adjusting.
2. If the aircraft flies straight but requires pressure on one rudder pedal to keep the ball in the centre then the rudder cable needs adjusting.

If the ball is centred and the rudder pedals are level but the aircraft tends to roll or turn then the flaps may need adjustment. Check the stall before making any changes to the flaps.

Slow the aircraft to near the point of stall in a clean configuration at idle power with the ball centred and note any tendency to roll just *before* the point of stall. If this happens then slow the aircraft to near the point of stall in a clean configuration several more times and note which wing drops just before the point of stall.

3. If the aircraft rolls just before the point of stall then the angle of incidence will need to be adjusted by means of the eccentric wing root bushes that are supplied with your kit. The correct installation procedure is explained later in this task.
4. If all flight up to the stall is wings level then the angle of incidence can be considered to be correct and any roll corrections can be made by individual adjustment of the flaps.

Slow the aircraft to V_{FE} , test the flaps at both half and full settings and then retract them.

Descent and landing

Descend to circuit height and conduct a normal approach and landing.

During the landing roll check that the undercarriage does not have any unusual noises, that the aircraft is easily controlled and that the brakes work evenly when applied.



Rigging corrective actions

It is particularly important that any rigging problems are dealt with in the correct sequence.

Use the flowchart below to work your way through any rigging problems: it may be necessary to step through the flowchart more than once, but the sequence is very important so work through each line one at a time, making corrections as indicated and retesting each time until the rigging is correct.

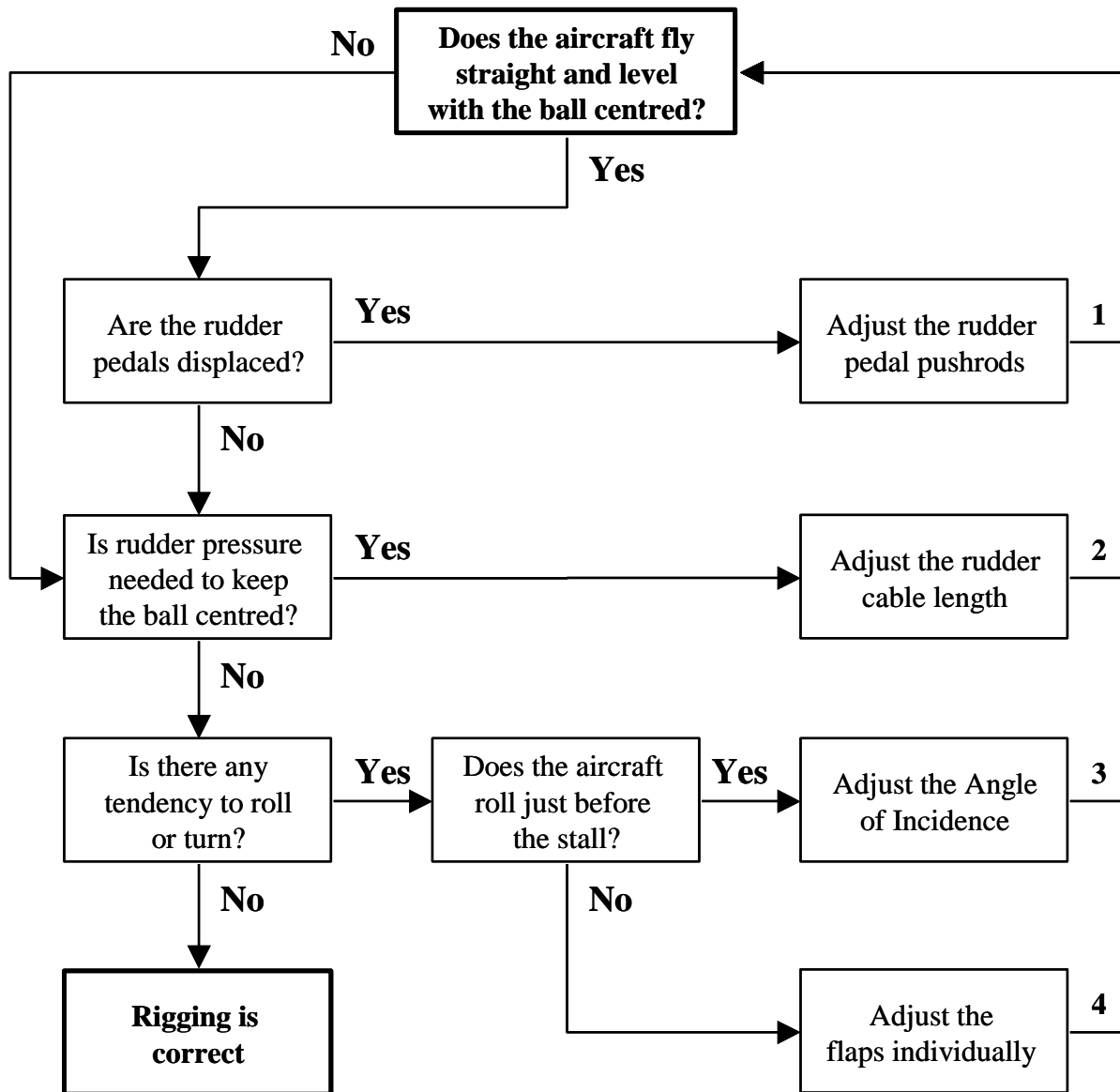

Retest the aircraft after each adjustment has been made and keep working through the flowchart from line #1 all the way to line #4 until you reach the “Rigging is correct” box at the bottom left of the chart.

The Flight Testing form *Sequence #2* should be printed out and used to record information while in flight. Print one form per test flight and retain each as a permanent record.



1. Adjusting the Rudder Pedal Pushrods

If the rudder pedals are displaced fore and aft when the aircraft is in straight and level flight, adjust the rudder pedal pushrods that connect the rudder pedals to the steering yoke until the pedals sit level. Retest and adjust as required.

2. Adjusting the Rudder Cable

If pressure is required on one rudder pedal to keep the aircraft straight in straight and level flight: if pressure is required on the right pedal then the rudder cable must be shortened, while if pressure is required on the left pedal then the rudder cable must be lengthened.

To alter the length of the rudder cable the rod ends must be removed from the connecting bolts, the lock nuts must be loosened and each rod end must be moved an equal amount, either in or out. Note that the rudder pedal stops must be readjusted at the same time.

It is not possible to predict the amount of adjustment required as each case will be different, but as a general guide try moving each rod end one full turn for a total of 2 full turns (1 at each end of the cable) and then test fly that configuration to see if more or less adjustment is required. Take careful note of each change and the effect on the flying qualities of the aircraft.

Care **must** be taken: the threaded end of the rudder cable must always be visible through the safety hole in each rod end, the lock nuts must be tightened against each rod end and the Nyloc nuts on the connecting bolts should be replaced before each test flight.

3. Adjusting the Angle of Incidence (AoI)

Use this procedure **only** if the aircraft repeatedly rolls towards the same wing just before the point of stall in a clean configuration as explained earlier in this task. The wing that drops is stalling slightly ahead of the other wing and it will need to have its angle of incidence reduced by a small amount. You will need to fit the eccentric bushes to the wing that drops to decrease the Angle of Incidence by 0.4° , which will entail placing the offset hole in the front bush UP and the offset hole in the rear bush DOWN. This very small change will be all that is required.

This procedure can be carried out without removing the wing from the aircraft.

Remove the wing root fairings. Chock the main wheels and support the outboard end of the wing. Remove the nuts from the wing root bolts and then very carefully tap each bolt out: as each bolt is removed, replace it with a length of stout wire of approximately 5mm thickness so that the wing root will not drop and damage the fuel lines or the side of the fuselage. Note carefully the position of the flat washers for reassembly.

Now the front wire can be removed and the wing can be slightly lifted so that the front bush is raised above the mounting lugs on the fuselage and the wing must then be held in this position by placing a bolt back through the front wing lug on the fuselage so that the wing lug can sit on the bolt. Take your time and make sure that the wing is unable to move or fall from this position by making sure that the outboard end of the wing is firmly supported fore and aft as well as underneath.

Heat the front bush with a soldering iron and remove it completely from the lug and clean away all of the flock from the bush mounting hole in the lug then tap the hole to 5/8" UNC in preparation for screwing in the eccentric bush.

It is very important that the tap be exactly square on to the lug and not angled in any way.

It may be necessary to remove a small amount of material from the leading edge at the wing root to allow a straight approach to the hole in the front lug when tapping the thread.

The wing root fairing will cover a small cutout here if it is required.



Test fit the eccentric bush into the wing lug dry, using a gently tapered object such as an old round file through the centre of the bush to screw the bush into the lug, ending when the bush is centred in the lug with offset hole facing UP to test the threads. Remove the bush.

Mix a very small batch of resin and separate it into 2 portions and then use one portion to coat the thread in the bush mounting hole in the wing lug and then coat the outside of the eccentric bush. Add flock to the other portion and apply a small amount to the bush and then screw the bush back into the lug, ending when the bush is centred in the lug with offset hole facing UP.

Wipe away all excess flock and lower the wing lug and bush back into the fuselage lugs and place the length of wire through the holes in the lugs and the bush.

Repeat the process for the rear bush, first test fitting the bush dry and then fitting it with resin and flock, but this time end with the offset hole in the bush facing DOWN.

Wipe away all excess flock and lower the wing lug and bush back into the fuselage lugs and hold in place with the wire. Leave the flock overnight to cure.

The next day fit the wing bolt through the lugs and the new bush. Refit the flat washers to the bolts as before. Remove the wire from the front bush and refit the wing bolt and flat washers.

Fit **new** Nyloc nuts to each wing bolt and tighten to safety. Do **not** reuse these nuts.

DO NOT OVERTIGHTEN THESE BOLTS. They should be just tight enough to prevent rotation. Over tightening may result in failure of the wing attach lugs.

Refit the wing root fairings. Retest the aircraft and, if required, make any small roll corrections by adjusting each flap individually.

4. Adjusting the Flaps

Use this procedure if the aircraft shows a tendency to roll in straight and level flight and *not* just before the point of stall in a clean configuration as mentioned in the previous step then minor adjustments may be made to each flap individually.

If the aircraft rolls to the left then the left flap may be lowered slightly, or the right flap may be raised slightly. If the aircraft rolls to the right then the right flap may be lowered slightly, or the left flap may be raised slightly.

Remove the wing root fairings as required to gain access to the flap pushrods. Remove the rod end connecting bolt from the drive yoke, loosen the lock nut and move the top rod end in or out and then refit the rod end to the drive yoke, tighten the lock nut. Refit the wing root fairings before each test flight.

It is not possible to predict the amount of adjustment required as each case will be different, but as a general guide try moving a rod end one full turn and then test fly that configuration to see if more or less adjustment is required. Take careful note of each change and the effect on the flying qualities of the aircraft.

If, for example, down adjustment becomes a problem on one flap then adjust the other flap up. If it becomes necessary to adjust the flap end of the pushrod, remove the flap to do so.

Care **must** be taken: the threaded end of the rod end must always be visible through the safety holes in each end of the pushrod, the rod end lock nuts must be tightened against each end of the pushrod and the Nyloc nut on the connecting bolt through the drive yoke should be replaced before each test flight.



Sequence #3 – Performance and handling

Print and use the Flight Testing form *Sequence #3* for each test flight in this sequence.

If all of the rigging corrections in *Sequence #2* have been done correctly and all equipment performs correctly then this sequence will usually only require one flight.

Record the date and engine hours as well as the wind direction and strength, the OAT, the Runway in use and the local QNH.

Loading rules

This Sequence is performed with either:

- Pilot weighing 100 Kg or less and 100 litres of fuel; or
- Pilot and 1 passenger for a combined weight of 172Kg or less and 50 litres of fuel.

Stalls

Climb at 80 KIAS using full power to 3000 feet AGL or higher, watching the engine instrumentation for any tendency towards overheating. If temperatures get near to the top of the green range increase airspeed to 90 KIAS improve the cooling airflow, and if temperatures are still too high then reduce power as required. Once established in a suitable test area, perhaps directly over the airfield, stall testing can start. During the course of the stall testing it will be necessary to climb back to the starting altitude from time to time.

The stalls are performed in the configurations listed on page 1 of the Flight Testing form *Sequence #3*.

Each stall is started from 60 KIAS and the aircraft is decelerated at a constant rate of 1 knot per second until the wing is fully stalled, which will require an increasing rearward rate of movement of the control stick.

Record the *Indicated Airspeed* (IAS) at which each stall occurs.

If anything out of the ordinary occurs during the stall testing phase record it in the Notes section at the end of the form.

Trim Speed Range

In the cruise configuration (2800-2900 rpm) record the trim speeds achieved at the full aft and full forward trim lever positions. Trim speed limitations are 50-65 KIAS in the aft trim position and 90-140 KIAS for the forward trim position.

In the approach configuration (full flap, engine at idle: 1000-1200 rpm) record the trim speeds achieved at the full aft and full forward trim lever positions. Trim speed limitations are: 60-70 KIAS in the aft trim position, and then trim forward until the airspeed reaches the end of the white arc (V_{FE}) on the ASI.

Glide at 62 KIAS

Retract the flaps, reduce the power to idle and trim the aircraft for a 62 KIAS glide.

Note the controllability and if the controls are rigged properly.

V_{NE}

Descend under power, typically 2700-2900 rpm, and approach V_{NE} in small speed increases. Note any vibration or buffeting as well as the overall controllability of the aircraft.

Do not exceed V_{NE} under any circumstances.



Maximum Power Flight

Descend to 1000 feet AGL, set the altimeter subscale to 1013.2 hPa and record the Pressure Altitude and OAT.

With the engine at wide open throttle and the aircraft in straight and level flight, record the indicated airspeed and engine rpm and the EOP, EOT, CHT and EGT (if fitted).

Timed Climb

Set the aircraft up in the cruise configuration at 2800-2900 rpm. Record the Pressure Altitude, which will also be the start height, and the OAT.

With the engine at wide open throttle and the aircraft trimmed to 80 KIAS, record the time taken to climb 1000 ft, the indicated rate of climb, the engine rpm and the EOP, EOT, CHT and EGT (if fitted).

Set the altimeter subscale back to the local QNH that you recorded before takeoff.

General

Record your observations of the following:

- Lateral & Directional Control Rigging
- Lateral & Directional Rigging and Trim
- Lateral & Directional Stability and Control
- Longitudinal Static Stability

Equipment

Test and record the operation and performance of the VHF comm(s), the transponder (if fitted), the GPS (if fitted), all flight and engine instrumentation and any other fitted equipment such as strobe and Nav lighting or UHF comm.

Ground handling during and after landing

When landing check that the undercarriage does not have any unusual noises, that the aircraft is easily controlled on the runway and that the brakes work evenly when applied.

Post flight

Immediately after landing and securing the aircraft record your observations of the overall characteristics of the aircraft and its systems as well as calculating the total engine hours and the fuel consumption rate.

When you are satisfied that the aircraft performs satisfactorily then this completes the *Testing > Flight testing* task and signals the end of this Manual as well.

The future

Congratulations, you have achieved something that most people can only dream about: you have built and flown your very own aircraft! This is a significant achievement and one that you can be justifiably proud of. Well done!

Please drop us a line here at Jabiru and tell us all about it, we would love to know.

We are sure that you will have many enjoyable hours of flying your very own Jabiru aircraft and we are equally sure that you will enjoy the low operating costs as well as the pleasurable flying characteristics that all Jabiru's share.



Testing>Forms

Objectives of this task:

This final task of the Constructors Manual contains a set of forms that are intended be used to record the details of your new Jabiru aircraft and all of the flight testing sequences.

The first form, *Aircraft Identification*, should be used to record the serial numbers of all components: the kit number, engine serial number, propeller details and all instrumentation.

The other forms should be used in conjunction with the preceding task *Flight Testing*.

Taken as a group these forms should be kept as a permanent record.

Abbreviations

Here is a listing of common abbreviations that are used throughout these forms:

AGL	Above Ground Level
AH	Artificial Horizon
ALT	Altimeter
CHT	Cylinder Head Temperature
EFIS	Electronic Flight Information System
EGT	Exhaust Gas Temperature
EMS	Engine Management System
EOP	Engine Oil Pressure
EOT	Engine Oil Temperature
ETC	Electric Turn Co-ordinator
GPS	Global Positioning System
IAS	Indicated Air Speed
ISA	International Standard Atmosphere: 1013.2 hPa, 15°C
KIAS	Knots Indicated Air Speed
MAG	Magneto - engine ignition system
OAT	Outside Air Temperature
P. ALT	Pressure Altitude: the indicated ALT at ISA conditions
RPM	Revolutions Per Minute - engine speed
RWY	Runway
UHF	Ultra High Frequency - sometimes used for remote area comms
VHF	Very High Frequency - standard aircraft comms
VSI	Vertical Speed Indicator



Aircraft Identification

Owner	<input type="text"/>	Phone	<input type="text"/>
Address	<input type="text"/>	Mobile	<input type="text"/>
		Fax	<input type="text"/>

Model	<input type="text" value="J"/>	Registration	<input type="text"/>
Kit #	<input type="text"/>	Engine Serial number	<input type="text"/>

Propeller: Jabiru / Sensenich (Cross out one)	Size x Pitch	<input type="text"/>
	Serial Number	<input type="text"/>

Flight instrumentation			
	Make/Serial number		Serial number
EFIS /AH	<input type="text"/>	ASI	<input type="text"/>
		ALT	<input type="text"/>
GPS	<input type="text"/>	VSI	<input type="text"/>
		ETC	<input type="text"/>

Engine instrumentation			
	Make/Serial number	Jabiru #	Serial number
EMS	<input type="text"/>	TACH	<input type="text"/>
		EOP	<input type="text"/>
		EOT	<input type="text"/>
		CHT	<input type="text"/>
		EGT	<input type="text"/>
		VOLT	<input type="text"/>



Sequence #1 – Ground run

Date

Engine hours start

WIND OAT

Pilot

Run up - 2000 rpm

	rpm drop (200rpm max)	<u>Engine parameters</u>	
Left MAG	<input type="text"/>	EOP	<input type="text"/>
Right MAG	<input type="text"/>	CHT	<input type="text"/>
Carb Heat	<input type="text"/>	EOT	<input type="text"/>
		EGT	<input type="text"/>
		All in the green range	

Full power check

Maximum sustained rpm	<u>Engine parameters</u>	
<input type="text"/>	EOP	<input type="text"/>
2975 – 3050 rpm	CHT	<input type="text"/>
Restrict the full power run to less than 2 minutes total time	EOT	<input type="text"/>
	EGT	<input type="text"/>
	All in the green range	

Idle check

Idle rpm	<u>Engine parameters</u>	
<input type="text"/>	EOP	<input type="text"/>
800 - 900 rpm	CHT	<input type="text"/>
Allow the engine to run at 1200 rpm for 2 minutes and then check the idle	EOT	<input type="text"/>
	EGT	<input type="text"/>
	All in the green range	

Taxi tests

Brakes both pull evenly and release with no drag

Steering: tracks straight into wind with feet off

Steering: left and right turns are equal radius

Notes



Sequence #2 – Rigging

Date

Engine hours start

WIND OAT

RWY P. ALT
1013.2 hPa

Loading

Pilot

Pilot only, no PAX,
20 litres of fuel per side

Full power climb at 80 KIAS

Engine RPM
2900 – 3050 rpm

EOP CHT

EOT EGT

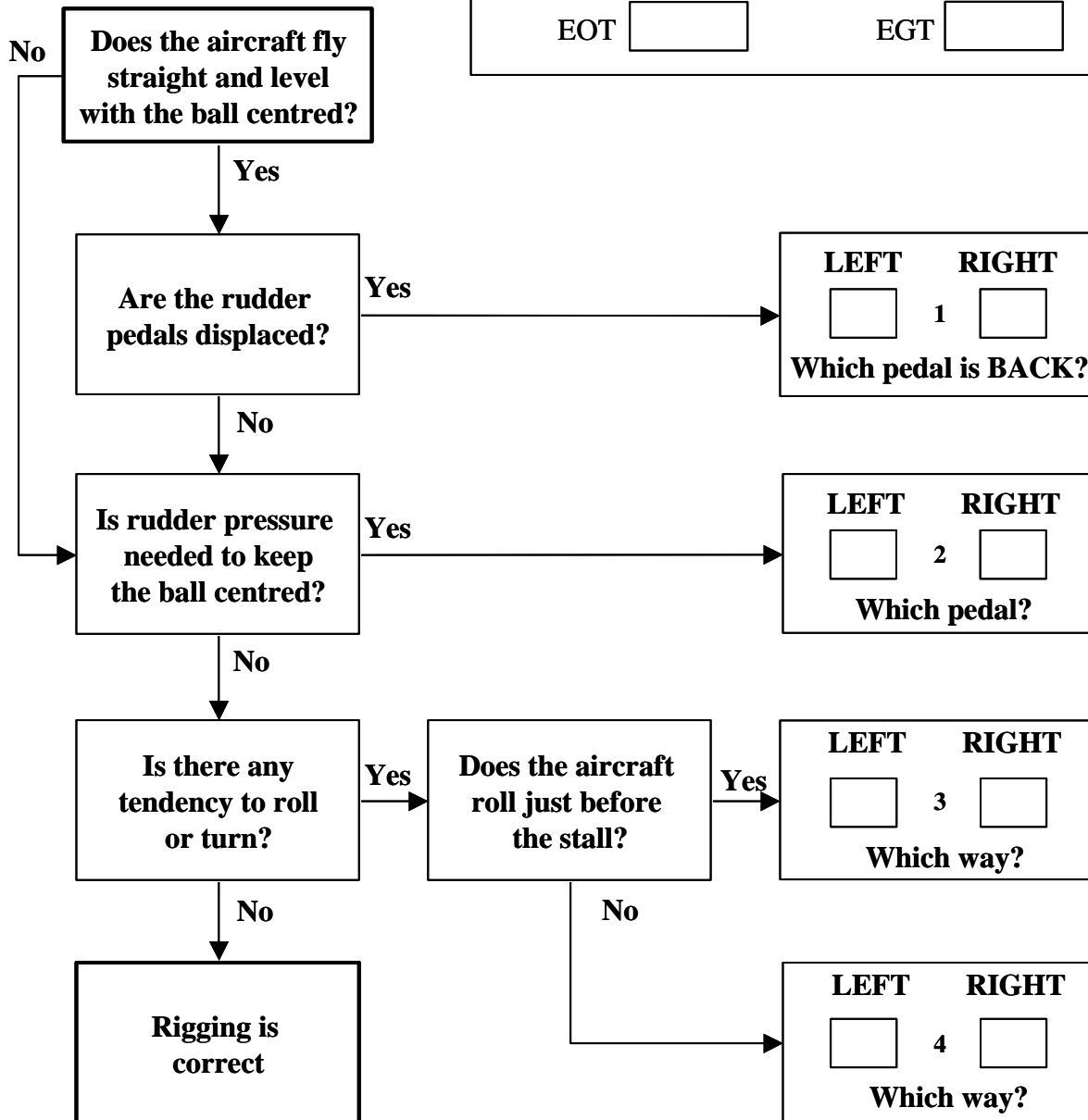



Sequence #3 – Performance & handling

page 1 of 3

Date <input style="width: 80%;" type="text"/>	WIND <input style="width: 80%;" type="text"/>	OAT <input style="width: 80%;" type="text"/>
Engine hours start <input style="width: 80%;" type="text"/>	RWY <input style="width: 80%;" type="text"/>	QNH <input style="width: 80%;" type="text"/>

Loading

Pilot <input style="width: 80%;" type="text"/>	Loading rules - either:
PAX <input style="width: 80%;" type="text"/>	Pilot < 100Kg only: 100 litres fuel; or <input type="checkbox"/>
	Pilot and 1 PAX to 172Kg total: 50 litres fuel <input type="checkbox"/>

Stalls

All stalls are started from 3000 feet AGL or above, starting from 60 KIAS. Airspeed is decreased at a constant rate of 1 knot per second until the aircraft is fully stalled and the IAS at the point of stall is recorded below.

IDLE power	NO Flap	Straight Ahead: [40 – 50] <input style="width: 80%;" type="text"/>
		30° Bank to LEFT <input style="width: 80%;" type="text"/>
		30° Bank to RIGHT <input style="width: 80%;" type="text"/>
	HALF Flap	Straight Ahead <input style="width: 80%;" type="text"/>
		30° Bank to LEFT <input style="width: 80%;" type="text"/>
		30° Bank to RIGHT <input style="width: 80%;" type="text"/>
	FULL Flap	Straight Ahead <input style="width: 80%;" type="text"/>
		30° Bank to LEFT <input style="width: 80%;" type="text"/>
		30° Bank to RIGHT <input style="width: 80%;" type="text"/>
FULL power	NO Flap	Straight Ahead: [38 – 45] <input style="width: 80%;" type="text"/>
		30° Bank to LEFT <input style="width: 80%;" type="text"/>
		30° Bank to RIGHT <input style="width: 80%;" type="text"/>
	HALF Flap	Straight Ahead <input style="width: 80%;" type="text"/>
		30° Bank to LEFT <input style="width: 80%;" type="text"/>
		30° Bank to RIGHT <input style="width: 80%;" type="text"/>
	FULL Flap	Straight Ahead <input style="width: 80%;" type="text"/>
		30° Bank to LEFT <input style="width: 80%;" type="text"/>
		30° Bank to RIGHT <input style="width: 80%;" type="text"/>



Sequence #3 – Performance & handling

page 2 of 3

Trim test

Cruise power, clean	Idle, full flap
AFT [50-65 KIAS] <input type="text"/>	AFT [60-70 KIAS] <input type="text"/>
FWD [90-140 KIAS] <input type="text"/>	FWD [end of white arc] <input type="text"/>

Glide at 62 KIAS

Controllability <input type="text"/>	Control rigging <input type="text"/>
Glide engine RPM <input type="text"/>	[1000-1200rpm]

V_{NE} 2700-2900 RPM

Vibration <input type="text"/>	Buffeting <input type="text"/>
Controllability <input type="text"/>	Control rigging <input type="text"/>

Full power, Straight & Level

IAS at full power <input type="text"/>	P. ALT 1013.2 hPa <input type="text"/>	OAT <input type="text"/>
RPM at full power <input type="text"/>	CHT <input type="text"/>	EOP <input type="text"/>
	EGT <input type="text"/>	EOT <input type="text"/>

Timed climb at 80 KIAS

Start P. ALT 1013.2 hPa <input type="text"/>	Finish P. ALT <input type="text"/>	OAT <input type="text"/>
Time to climb 1000 ft <input type="text"/> sec	CHT <input type="text"/>	EOP <input type="text"/>
Rate of climb (indicated) <input type="text"/> fpm	EGT <input type="text"/>	EOT <input type="text"/>

General

Lateral & Directional Control Rigging <input type="text"/>	Lateral & Directional Stability and Control <input type="text"/>
Lateral & Directional Rigging and Trim <input type="text"/>	Longitudinal Static Stability <input type="text"/>



Sequence #3 – Performance & handling

page 3 of 3

Equipment

VHF Comm #1 operation	<input type="text"/>	VHF Comm #2 operation	<input type="text"/>
Transponder operation	<input type="text"/>	GPS operation	<input type="text"/>
Instrumentation	<input type="text"/>	Other equipment: Lights, UHF, etc	<input type="text"/>

Ground handling

Control - landing	<input type="text"/>	Brakes - landing	<input type="text"/>
Control - taxi	<input type="text"/>	Brakes - taxi	<input type="text"/>
Undercarriage	<input type="text"/>	Steering	<input type="text"/>

Post flight review

Trim and handling characteristics satisfactory? <input type="checkbox"/>	Engine operation throughout satisfactory? <input type="checkbox"/>
Stalls satisfactory? <input type="checkbox"/>	Stability satisfactory? <input type="checkbox"/>
Control rigging satisfactory? <input type="checkbox"/>	
Avionics operation throughout satisfactory? <input type="checkbox"/>	Instrumentation operation throughout satisfactory? <input type="checkbox"/>
Engine hours finish <input type="text"/>	Fuel used <input type="text"/> L
Engine hours total <input type="text"/>	Fuel consumption rate <input type="text"/> L/hr

Notes